

Instructions for use  
**oven**

**ATAG**



ZX4574MN

ZX6574M

**Pictograms used**



Important information



Tip

---

# CONTENTS

---

## ***Your oven***

---

Introduction	4
Control panel	5
Description	6
Guide rails/Telescopic guide rails	6
Accessories	7
Door	8
Cooling fan	8
Touch screen	9
Main displays	10
Function-setting display	12
Stand-by display	13

## ***Initial use***

---

Initial use	14
-------------	----

## ***Operation***

---

Using the 'Plus' menu	16
Opening the keyboard	18

## ***Use***

---

Oven function	19
Using the 'Extras' functions	21
Fast preheat	22
Functions table	23
Culisensor	27
Delayed start	30
Stage cooking	31
Additional functions	34
Settings	38

## ***Cleaning***

---

Cleaning the appliance	40
Steam clean	40
Pyrolysis	41
Removing and cleaning the guide rails	42
Replacing the oven light bulb	43
Removing the oven door	44
Removing the oven window	45

## ***Solving problems***

---

General	46
---------	----

## ***Your oven and the environment***

---

Disposal of the appliance and packaging	48
---	----

## ***Cooking test***

---

Food tested in compliance with the EN 60350-1 standard	49
--	----

## *Introduction*

---

Congratulations on choosing this ATAG oven.

This product is designed to offer simple operation and optimum user-friendliness. The oven has a wide range of settings enabling you to select the correct cooking method every time.

This manual shows how you can best use this oven. In addition to information about operating the oven, you will also find background information that may be useful when using the appliance.



**Please read the separate safety instructions carefully before using the appliance!**

**Read this manual before using the appliance and keep it in a safe place for future use.**

Installation instructions are supplied separately.

## Control panel

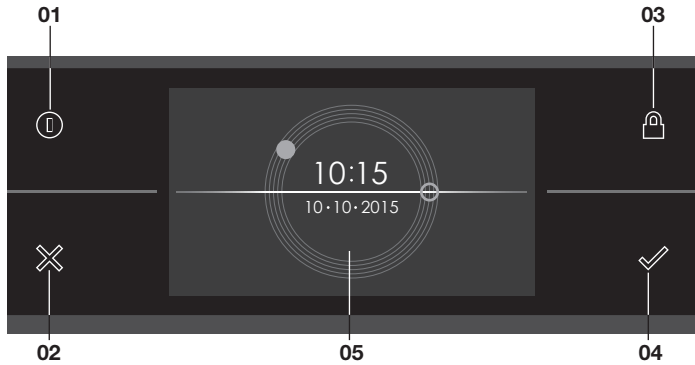

01. On/Off key; use to:
  - switch on the appliance.
  - switch to stand-by
  - switch off the appliance. Keep the 'On/Off' key pressed until the appliance switches off.
02. X key; use to:
  - go a step back in the menu.
  - close or answer 'No' to a pop-up.
  - close or cancel a menu or function.
03. Key lock key; use to:
  - Lock all the keys to clean the control panel or to prevent that the appliance gets into progress accidentally. Hold the key pressed until the key lock is enabled.
04. Confirm key; use to:
  - confirm settings
  - start a function.
  - close or answer 'Yes' to a pop-up.
05. Touch screen/display

# YOUR OVEN

## Description

1. Control panel
2. Oven levels
3. Oven door
4. Door handle

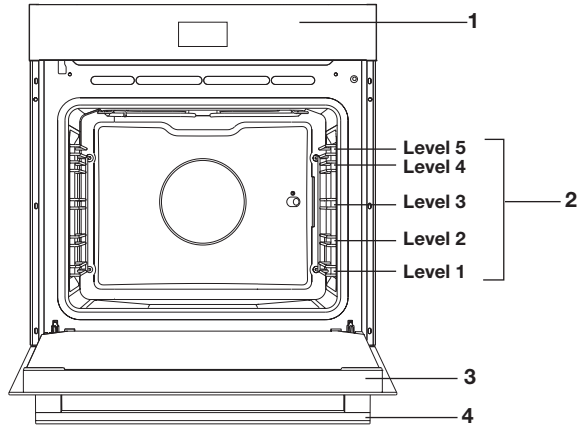

## Guide rails/Telescopic guide rails

- The oven has four or five guide rails (Level 1 to 4/5), depending on the model. Level 1 is mainly used in combination with bottom heat. The two upper levels are mainly used for the grill function.
- Place the oven rack, baking tray or steam dish in the gap between the guide rail sliders.
- A number of shelf levels can have fully-retractable telescopic guide rails, depending on the model.
  - Pull the telescopic guide rails out of the oven cavity completely and place the oven rack / baking tray / steam dish on them. Then slide the oven rack / baking tray / steam dish on the telescopic guide rails, back into the oven cavity.
  - Only close the oven door when the telescopic guide rails have been returned completely back into the oven cavity.







**Note: remove the guide rails / telescopic guide rails out of the oven if you are going to use the Pyrolysis function!**

# YOUR OVEN

## Accessories

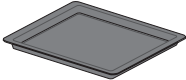
Your appliance is accompanied by a range of accessories, depending on the model. Only use original accessories; they are specially suited to your appliance.

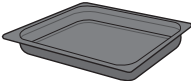
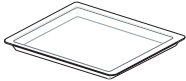
**Note:** not all accessories are suitable/available for every appliance (it may also differ by country). When purchasing, always provide the exact identification number of your appliance. Please see the sales brochures or check online for more details about optional accessories.

Accessories that can be supplied with your appliance (depending on the model)	
	<p><b>Enamelled baking tray;</b> to be used for pastries and cakes.</p> <ul style="list-style-type: none"><li>• Do not use the enamelled baking tray for microwave functions!</li><li>• Suitable for pyrolysis cleaning.</li></ul>
	<p><b>Oven rack;</b> mainly used for grilling. A steam dish or pan with food can also be placed on the oven rack.</p> <ul style="list-style-type: none"><li>• The oven rack is equipped with a safety peg. Lift the rack slightly at the front to slide it out of the oven.</li><li>• Do not use the oven rack for microwave functions!</li></ul>
	<p><b>Deep enamelled baking tray;</b> to be used for roasting meat and baking moist pastry. It can also be used as a drip tray. Place the deep baking tray into the first level for use as a drip tray during grilling.</p> <ul style="list-style-type: none"><li>• Do not use the deep enamelled baking tray for microwave functions!</li><li>• Suitable for pyrolysis cleaning.</li></ul>
	<p><b>Glass baking tray;</b> for microwave and oven use.</p> <ul style="list-style-type: none"><li>• NOT suitable for pyrolysis cleaning.</li></ul>
	<p><b>Rotisserie + Spit roast;</b> used for roasting all kinds of dishes such as rolled meats or chicken.</p>
	<p><b>Culisensor;</b> can be used to measure the core temperature of the dish. When the desired temperature is reached, the cooking process will be stopped automatically.</p>
	<p><b>Pyrolysis guide rails;</b> only use these guide rails to clean an enamelled baking tray during pyrolysis (replace the guide rails / telescopic guide rails with these special pyrolysis guide rails).</p> <ul style="list-style-type: none"><li>• Please note: the high temperature during pyrolysis may cause the pyrolysis guide rails to discolour.</li></ul>

## Rotisserie

The rotisserie comprises a spit with 2 clamps, a detachable handle and a spit roast that fits in the centre of the oven. The spit fits in the rotisserie motor in the back wall of the oven.

- Slide the deep baking tray in at level 1 to catch juices or fat.
- Slide one of the clamps onto the spit and then slide the meat you wish to roast onto the spit.
- Place the spit roast in the central oven level with the 'v' shape to the front.
- The handle can be screwed onto the blunt end of the spit to make positioning the spit easier.
- Place the spit on the spit roast with the pointed end away from you. Push gently until the spit fits in the rotisserie motor in the back wall. The blunt end of the spit needs to fit in the 'v' shape. (The spit has two notches, both of which need to be mounted on the oven door side so that the spit stays in position. The notches also serve as a grip for the handle.)
- The rotisserie motor starts running when a function with grill has been started
- Remove the handle prior to baking or roasting. You can then reattach the handle to the spit to remove this from the oven easily.

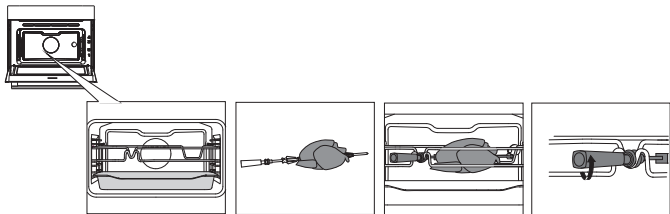

## Door

---

- The door switches interrupt the operation of the oven when the oven door is opened during use. The oven resumes operation when the door is closed.
- This oven has a 'Soft close door system'. When closing the oven door, this system dampens the movement, from a certain angle, and silently closes the oven door.

## Cooling fan

---

- The appliance is equipped with a cooling fan that cools the casing and control panel.



## Touch screen

- Operate your oven's touch screen by tapping or swiping it.
- Tap the display to open a function or adjust a setting.
- Swipe the display for further information/show options or adjust a setting.

### Tapping:

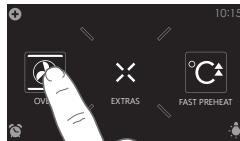

### Swiping:



*For the best response, touch the keys with the main part of your fingertip. Every time you tap a key during use, a short tone will sound (unless this is adjusted in the settings).*

## Main displays

### Start display

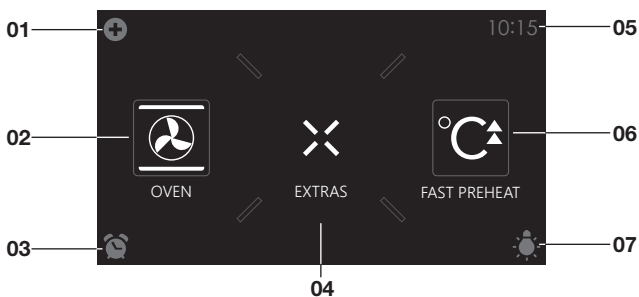

#### Plus menu (01)

- Tap the plus symbol to open the 'Plus' menu. The contents of this menu change according to the control options available at that time.

#### Oven (02)

- Tap 'OVEN' to open the oven function menu.

#### Egg timer (03)

- Tap the egg timer symbol to open the egg timer menu. The egg timer can be used independently from the oven function.
  - The longest possible alarm time is 24 hours.
  - When an egg timer goes off, a pop-up will appear and an acoustic signal will sound.
  - Tap on the X key, confirm key or the display to switch off the signal and close the pop-up. The sound signal will stop automatically after approximately 1 minute.

#### Extras (04)

- Tap on 'EXTRAS' to show the appliance's extra functions.

#### Time (05)

- The time is shown here.

#### Fast preheat (06)

- Tap on 'FAST PREHEAT' to open the fast preheat function.

## Light (07)

- Tap on the 'lamp' symbol to switch the oven light on or off.
- The oven light will also light up when you open the oven door or start cooking. The oven light will dim automatically (unless this is adjusted in the settings).

## Extras display

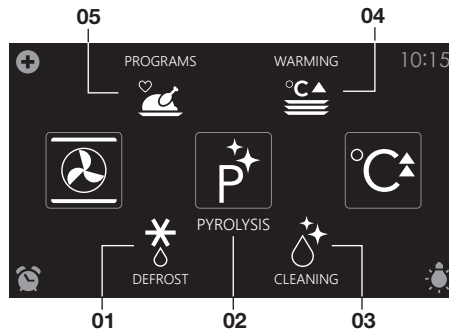

## Defrost (01)

- Tap on 'DEFROST' to open the defrost function.

## Pyrolysis (02)

- Tap on 'PYROLYSIS' to open the pyrolysis function.

## Cleaning (03)

- Tap on 'CLEANING' to open the cleaning function.

## Warming (04)

- Tap on 'WARMING' to open the warming function menu.  
Plate warming and keep warm can be found here.

## Programs (05)

- Tap on 'PROGRAMS' to open the programs menu. The favourites and automatic programs can be found here.

## Function-setting display

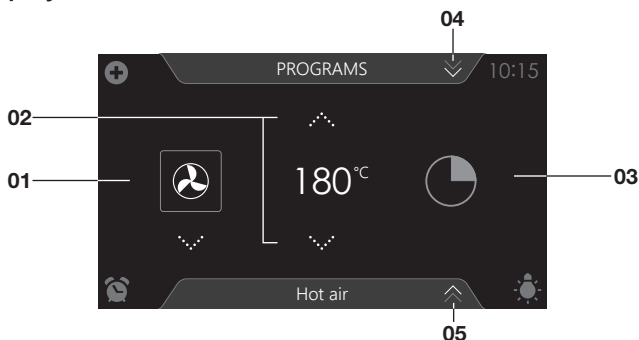

### **Selecting a function (01)**

- Tap on the arrows above and below the function or sweep over the symbol to select a function (see also 'Opening the Keyboard').

### **Setting the temperature (02)**

- Tap on the arrows above and below the temperature or sweep over the temperature indicator to select a temperature or (see also 'Opening the Keyboard').

### **Cooking time (03)**

- Tap the cooking time symbol if you want to set a cooking time. If a cooking time is already stated, it is necessary to set this.
- Tap on the arrows above and below the time or swipe over the time to adjust it (see also 'Opening the Keyboard').

### **Programs (04)**

- Tap on 'PROGRAMS' to open the program menu. The favourites and automatic programs can be found here.

### **Info tab (05)**

- The name of the selected function appears in the bottom tab of the display. Tap on the tab to request more information about the selected function.

## Stand-by display

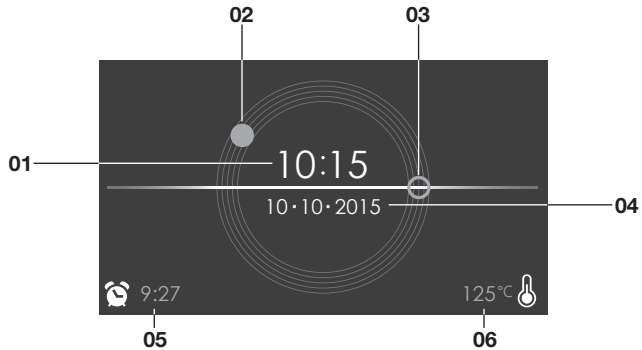

### **Display time (digital/01)**

- Actual time of day.

### **Display time (analog/02 and 03)**

- Actual time of day.
- The hour hand of the analog clock is indicated with a 'closed' circle (02) and the minute hand with an 'open' circle (03).

### **Display of date (04)**

- Actual date.

### **Display egg timer (05)**

- The expiring egg timer.

### **Display descending temperature (06)**

- Actual temperature in the oven (waste heat).

## *Initial use*

---

- Clean the oven interior and accessories with hot water and washing-up liquid. Do not use aggressive cleaning agents, abrasive sponges and similar.
- The oven will emit a particular odor when it is used for the first time; this is normal. Make sure that there is good ventilation during initial use.



When the appliance is plugged in for the first time or after the appliance was disconnected from the mains for a longer period of time, you have to set 'Language', 'Time' and 'Date'.

### **Setting the language**

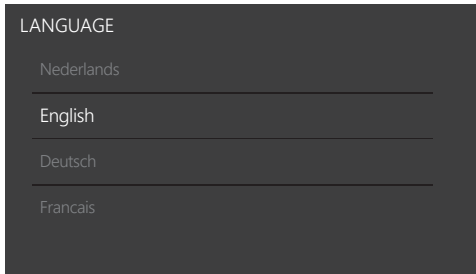

Set the desired language in which the appliance's display texts will appear. 'English' is selected as standard.

1. Swipe over the display to view all languages.
2. Tap on a language to select this.
3. Press on the confirm key to save the set language.



## Setting the time

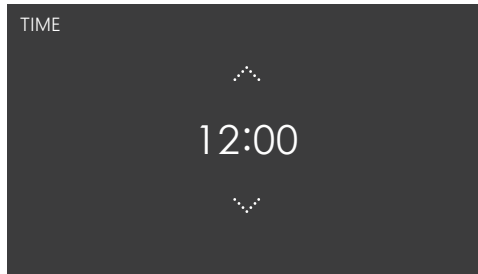

1. Tap on the arrows above and below the time or swipe over the time to adjust it.
2. For fast entry, tap in the centre of the time display; a pop-up keyboard will appear on which the desired time can be typed (see 'Opening the Keyboard' chapter).
3. Press on the confirm key to save the set time.



## Setting the date

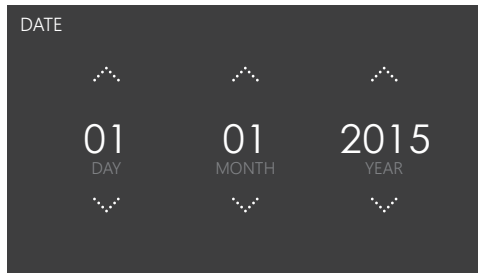

1. Tap on the arrows above and below the day, month or year or swipe over the day, month or year to adjust these.
2. Press on the confirm key to save the set date.  
The appliance is now ready for use.



*The language, time and date can be adjusted in the settings menu (see 'Settings' chapter). The settings menu can be opened from the start display via the 'Plus' menu.*

## Using the 'Plus' menu

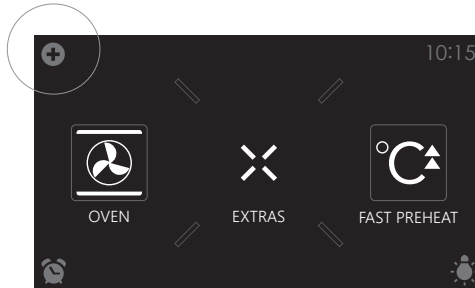

The 'Plus' menu comprises a number of functions or settings. The offered plus functions depend on the display that is active.

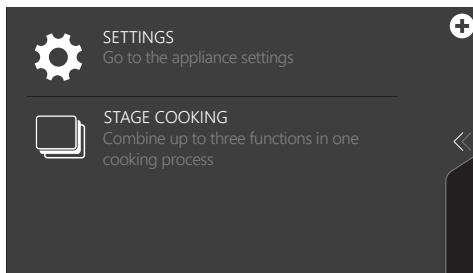

- From the start display, the following functions/menus can be found in the 'Plus' menu:
  - **Settings;** Set your preferences (see 'Settings' chapter).
  - **Stage cooking;** Combine up to three functions in one cooking process (see 'Stage cooking' chapter).



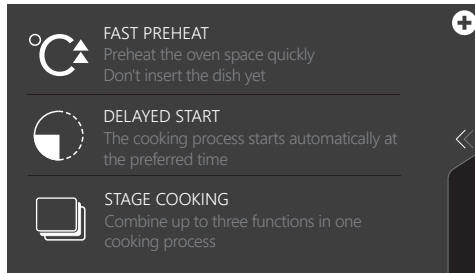

- From the oven function-settings display, the following functions can be found in the 'Plus' menu:
  - **Fast preheat;** Preheat the oven space quickly to the desired temperature within a cooking process (see 'Fast preheat' chapter).
  - **Delayed start;** The cooking process will start automatically at the time you set.
  - **Stage cooking;** Combine up to three functions in one cooking process (see 'Stage cooking' chapter).



- When an oven function is started, the following functions can be found in the 'Plus' menu:
  - **Add to favourites;** Add the settings for the cooked dish to your favourites (see 'Additional functions' chapter).

## Opening the keyboard

A keyboard can be opened for fast entry of a function, temperature or cooking time. A quick setting can be selected with this or a value can be entered.

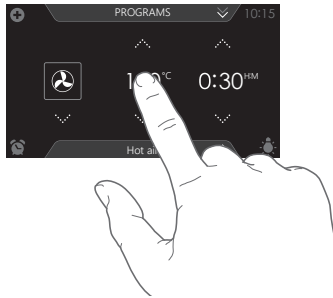

1. Tap in the centre of the function symbol, temperature or cooking time (activated). The keyboard appears.

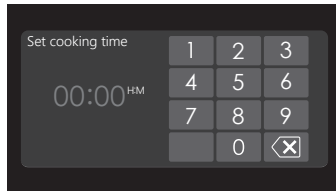
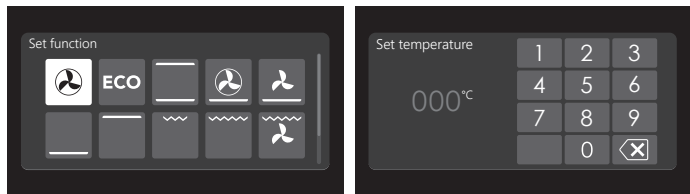

2. Enter the desired value or tap the desired value.
3. If the set value is not confirmed automatically, press on the confirm key to confirm the entry.

## Oven function

Use the oven functions to cook dishes using, for instance, hot air, bottom heat or grill.

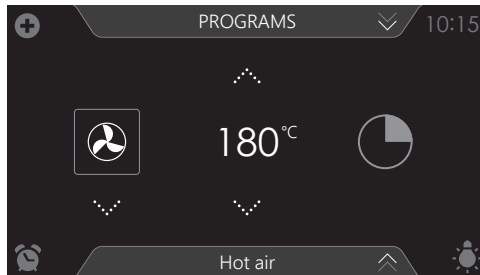

- Various oven functions can be selected.
- A temperature and a cooking time can be set for each oven function.
- 'Plus' menu functions such as fast preheat, stage cooking and delayed start can also be selected. Tap on the plus symbol for this. See the 'Using the 'Plus' menu' chapter.

### Using an oven function

Select the oven function appropriate for the meal you are cooking. Consult the Functions table for this. You can also consult the info tab. Tap on the tab at the bottom of the display to request more information about the selected function.

1. Switch on the oven using the 'On/Off' key.
2. Place the dish in the oven.
3. Tap 'OVEN' to open the oven function menu.
4. Select an oven function (see 'Function-setting display' chapter).
5. Select a temperature (see 'Function-setting display' chapter).
6. Tap the 'cooking time' symbol and set a cooking time (see 'Function-setting display' chapter).



*Cooking can also be started without a cooking time being set. You should then skip step 6.*

7. Select any additional settings using the 'Plus' menu (for example fast preheat).
8. Start cooking the dish using the confirm key.



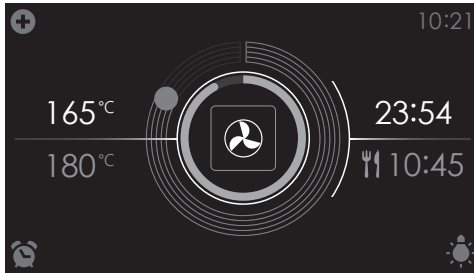

- The following values can now be read in the display:
  - current temperature (165 °C)
  - set temperature (180 °C)
  - status indicator time (outer circle)
  - status indicator temperature (inner circle)
  - cooking time (23:54)
  - end time (10:45)



- *Tap in the middle of the display during cooking to open a pop-up display with settings. Adjust these if desired.*
- *At the end of a dish's cooking time a sound signal will sound. The signal can be switched off by opening the oven door or pressing a key.*
- *The selected settings can be saved in 'Favourites'. Open 'ADD TO FAVOURITES' from the 'Plus' menu (see 'Saving a cooking method' in the 'Additional functions' chapter).*

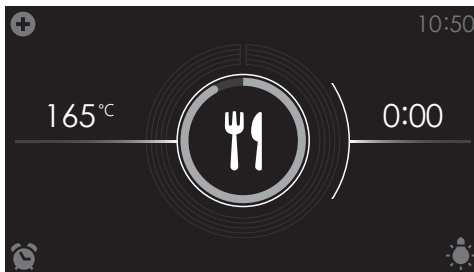

*Display view at the end of cooking.*

## Using the 'Extras' functions

Open the 'Extras' display to select the pyrolysis function. A cleaning program, warming functions or automatic programs can also be selected.



Tap on 'EXTRAS' to show the appliance's extra functions.

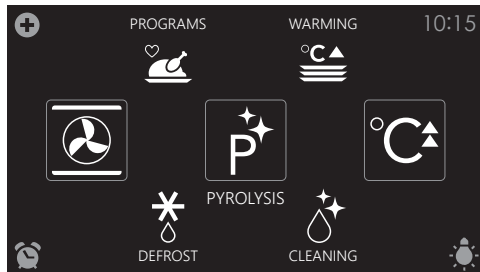

The following programs can now be selected:

- Pyrolysis (see 'Cleaning' chapter)
- Cleaning (see 'Cleaning' chapter)
- Warming (see 'Additional functions' chapter):
  - Plate warming
  - Keep warm
- Programs (see 'Additional functions' chapter):
  - Favourites
  - Automatic programs
- Defrost

## *Fast preheat*

Use this oven function for preheating the oven quickly. Don't insert a dish during Fast preheat. When the oven is heated to the set temperature, preheating is finished and the oven is ready to cook the dish.

### **Using fast preheat**

1. Switch on the oven using the 'On/Off' key.
2. Tap on the 'FAST PREHEAT' to open fast preheat function.

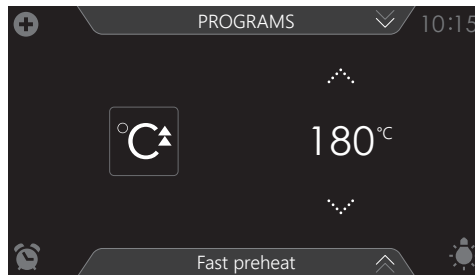

3. Select a temperature (see 'Function-setting display' chapter).
4. Start fast preheat using the confirm key.







- *Fast preheat can also be linked to a cooking process.*
- *Activate 'FAST PREHEAT' from the 'Plus' menu to do so.*
- *When the set temperature is reached, a pop-up will appear and a sound signal sounds.*
- *The cooking time starts counting up or down after door closing.*





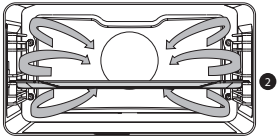

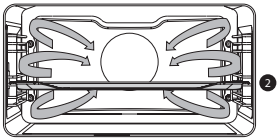
## Functions table

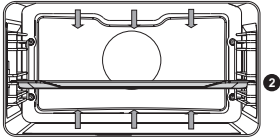
Consult the table to choose the desired function. Also consult the instructions for preparation on the dish packaging.

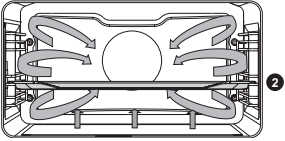

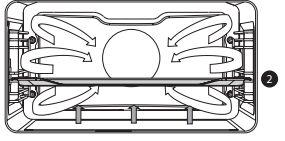

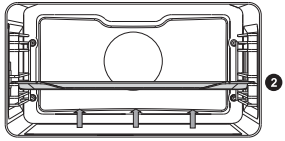

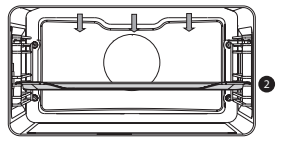



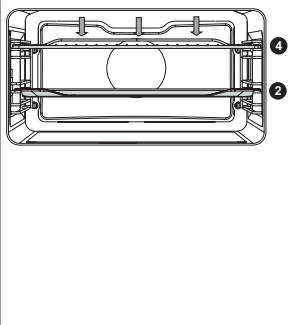

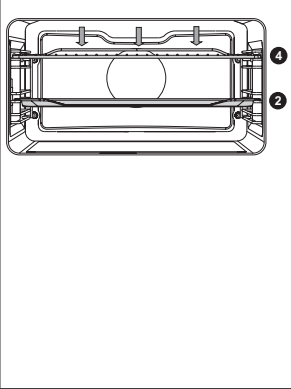

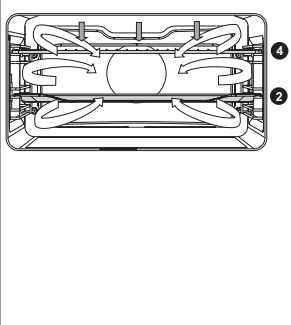
- **Only use glass dishes that can withstand temperatures of 250 °C.**

Function	Description	
<b>Oven functions</b>		
	<p><b>Hot Air</b></p> <ul style="list-style-type: none"> <li>• Heating by means of hot air from the back of the oven.</li> <li>• This mode provides uniform heating and is ideal for baking.</li> <li>• Place the tray on level 2.</li> <li>• Suggested temperature: 180 °C</li> <li>• Preheating is recommended.</li> </ul>	
	<p><b>ECO Hot air</b></p> <ul style="list-style-type: none"> <li>• Heating by means of hot air. ECO hot air uses less energy but gives the same result as the hot air setting. Cooking takes a few minutes longer.</li> <li>• This mode can be used for roasting meat and baking pastry.</li> <li>• Place the tray on level 2.</li> <li>• Suggested temperature: 180 °C</li> <li>• This setting makes use of the residual heat (heating is not on the whole time) to achieve low energy consumption (in accordance with energy class EN 60350-1). In this mode the actual temperature in the oven is not displayed.</li> </ul>	
	<p><b>Top + Bottom heat</b></p> <ul style="list-style-type: none"> <li>• Heating by means of the upper and lower heating elements.</li> <li>• This mode can be used for traditional baking and roasting.</li> <li>• Place the baking tray or oven rack on level 2.</li> <li>• Suggested temperature: 200 °C</li> <li>• Preheating is recommended.</li> </ul>	

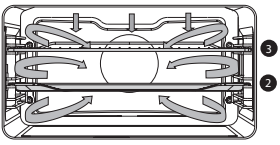
Function	Description	
	<p><b>Hot air + Bottom heat</b></p> <ul style="list-style-type: none"> <li>• Heating by means of hot air from the back of the oven and the bottom heating element.</li> <li>• This mode can be used to bake pizza, moist pastry, fruitcakes, leavened dough and short crust.</li> <li>• Place the baking tray or oven rack on level 2.</li> <li>• Suggested temperature: 200 °C</li> <li>• Preheating is recommended.</li> </ul>	
	<p><b>Bottom heat + Fan</b></p> <ul style="list-style-type: none"> <li>• Heating by means of the lower heating element. The heat is distributed by the fan.</li> <li>• This mode can be used for baking low leavened cakes, as well as for preservation of fruit and vegetables.</li> <li>• Place a not too high baking tray on level 2, so that hot air can also circulate over the upper surface of the food.</li> <li>• Suggested temperature: 180 °C</li> </ul>	
	<p><b>Bottom Heat</b></p> <ul style="list-style-type: none"> <li>• Heating only by means of the lower heating element.</li> <li>• This mode can be used with dishes and baked goods that require a distinctive bottom crust or browning.</li> <li>• Place the baking tray or oven rack on level 2.</li> <li>• Use just before the end of the baking or roasting time.</li> <li>• Suggested temperature: 160 °C</li> </ul>	
	<p><b>Top Heat</b></p> <ul style="list-style-type: none"> <li>• Heating only by means of the upper heating element.</li> <li>• This mode can be used when you wish to bake/roast the top part of your dish.</li> <li>• Place the baking tray or oven rack on level 2.</li> <li>• Suggested temperature: 150 °C</li> </ul>	



Function	Description	
	<p><b>Grill</b></p> <ul style="list-style-type: none"> <li>• Heating by means of the grill element.</li> <li>• This mode can be used for grilling a smaller amount of open sandwiches, beer sausages, and for toasting bread.</li> <li>• Place the oven rack is on level 4 and the baking tray on level 2.</li> <li>• <b>Maximum allowed temperature 240 °C.</b></li> <li>• Monitor the cooking process at all times. The dish may burn quickly due to the high temperature.</li> <li>• Preheat for 5 minutes.</li> </ul>	
	<p><b>Large Grill</b></p> <ul style="list-style-type: none"> <li>• Heating by means of the upper element and grill element.</li> <li>• This mode can be used with dishes and baked goods that require a distinctive bottom crust or browning. Use just before the end of the baking or roasting time.</li> <li>• Place the the oven rack on level 4 and the baking tray on level 2.</li> <li>• <b>Maximum allowed temperature 240 °C.</b></li> <li>• Monitor the cooking process at all times. The dish may burn quickly due to the high temperature.</li> <li>• Preheat for 5 minutes.</li> </ul>	
	<p><b>Large grill + fan</b></p> <ul style="list-style-type: none"> <li>• Heating by means of the top heating elements. The heat is distributed by the fan.</li> <li>• This mode can be used for grilling meat, fish and vegetables.</li> <li>• Place the oven rack on level 4 and the baking tray on level 2.</li> <li>• Suggested temperature: 170 °C</li> <li>• Monitor the cooking process at all times. The dish may burn quickly due to the high temperature.</li> <li>• Preheat for 5 minutes.</li> </ul>	

Function	Description	
	<p><b>Pro Roasting</b></p> <ul style="list-style-type: none"> <li>• This setting has an automatic heating cycle.</li> <li>• First the meat is sealed at a high temperature by means of hot air and the top heating element.</li> <li>• Then the dish is slowly cooked at the low, preset temperature, with the top and bottom heating elements.</li> <li>• This function is suitable for meat, poultry and fish.</li> <li>• Suggested temperature: 180 °C</li> </ul>	
	<p><b>Fast preheat</b></p> <ul style="list-style-type: none"> <li>• With this function, the oven cavity is quickly heated to the desired temperature. Do not use this setting when you have a dish in the oven.</li> <li>• Suggested temperature: 180 °C</li> </ul>	
<p><b>Extra functions</b></p>		
	<p><b>Plate warming</b></p> <ul style="list-style-type: none"> <li>• This function is used for warming tableware, so that the served food stays hotter for longer.</li> <li>• Suggested temperature: 60 °C</li> </ul>	
	<p><b>Defrost</b></p> <ul style="list-style-type: none"> <li>• With this function, the air circulates by means of the fan. The air will be heated to a temperature of 30 °C.</li> <li>• Use this function to defrost frozen dishes.</li> </ul>	
	<p><b>Keep warm</b></p> <ul style="list-style-type: none"> <li>• This function is used to keep already cooked dishes warm.</li> <li>• Suggested temperature: 60 °C</li> </ul>	
	<p><b>Steam clean</b></p> <ul style="list-style-type: none"> <li>• With this function and a damp cloth, you can easily remove grease and dirt from the oven walls.</li> <li>• Use this function only when the oven has cooled down fully. Pour 0,15 liters of water onto the bottom of the oven space before starting the cleaning process.</li> <li>• After soaking, food residues can be removed with a damp cloth.</li> </ul>	

Function	Description	
	<p><b>Pyrolysis</b></p> <ul style="list-style-type: none"> <li>• This function is intended for the automatic cleaning of the oven. The oven heats up to a temperature far above normal use, ensuring grease residues and other dirt are reduced to ash.</li> <li>• Before using this process, remove all accessories and loose food residues from the oven cavity. During the pyrolytic self-cleaning process, the oven door is automatically locked above a certain temperature. The outside of the oven becomes hotter than usual.</li> <li>• When the oven is completely cool, the inside can be wiped clean with a damp cloth.</li> </ul>	

## Culisensor

### Roasting with the culisensor

For roasting with the culisensor, set the desired core temperature of the dish. The oven will heat up until the dish's core temperature is reached. The culisensor measures the core temperature of the dish.

1. Switch on the oven using the 'On/Off' button.
2. Screw the metal cover from the connection point (front top corner of the right side wall).
3. Put the culisensor plug in the connection and insert the culisensor completely into the food.

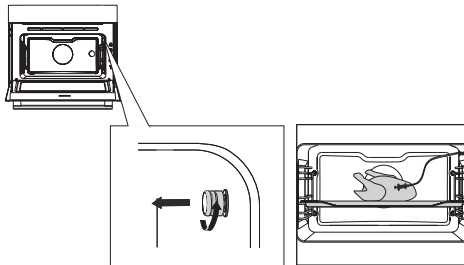

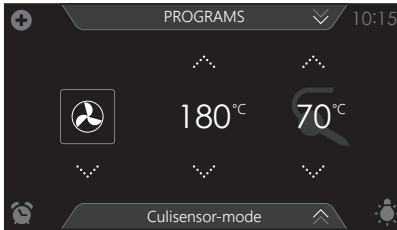

4. Select an oven function, temperature and core temperature. (see 'Function-setting display' chapter)
5. Start cooking the dish using the confirm key.

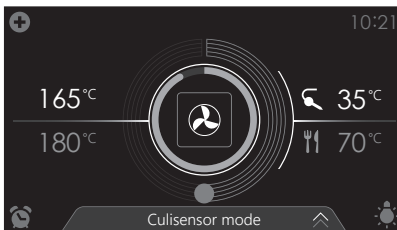

- The following values can now be read in the display:
  - current temperature (165 °C)
  - set temperature (180 °C)
  - status indicator core temperature (outer circle)
  - status indicator temperature (inner circle)
  - current core temperature (35 °C)
  - set core temperature (70 °C)
- The cooking process ends when the set core temperature has been reached. At the end of the cooking process a sound signal will sound. The signal can be switched off by opening the oven door or pressing a key.



- **Always place the culisensor's entire metal sensor in the dish.**
- **Please note! After the cooking process always replace the metal cap on the culisensor's connection.**
- **Only use the culisensor in your oven.**
- **Ensure that the culisensor does not come into contact with the heating element during cooking.**
- **The culisensor will be extremely hot after the cooking process. Be careful! Avoid burns.**

**Recommended core temperature**

<b>Beef</b>		
Fillet/sirloin	medium	55 - 58° C
Roast beef	medium	55 - 60° C
Round steak	well-done	85 - 90 °C
Roast beef	well-done	80 - 85 °C
Stewed beef	well-done	90 °C
<b>Pork</b>		
Hoof/leg	well-done	75 °C
Hoof/leg	slightly pink	65 - 68 °C
Pork loin	slightly pink	65 - 70 °C
Pork shoulder	well-done	75 °C
Pork belly/stuffed	well-done	75 - 80 °C
Pork belly	well-done	80 - 85 °C
Roast pork hoof	well-done	80 - 85 °C
Pork hoof	well-done	80 - 85 °C
<b>Pork</b>		
Cooked ham	very tender	64 - 68 °C
Kassel ribs	well-done	65 °C
Breaded ham		65 - 68 °C
<b>Veal</b>		
Veal loin	slightly pink	58 - 65 °C
Veal hoof/leg of veal	well-done	78 °C
Fried kidneys	well-done	75 - 80 °C
Roast veal/shoulder	well-done	75 - 80 °C
Leg of veal	well-done	75 - 78 °C
<b>Mutton</b>		
Mutton loin	pink	65 - 70 °C
Mutton loin	well-done	80 °C
Mutton hoof	pink	70 - 75 °C
Leg of mutton		82 - 85 °C
<b>Lamb</b>		
Leg of lamb	pink	60 - 62 °C
Leg of lamb	well-done	68 - 75 °C
Lamb loin	pink	54 - 58 °C
Lamb loin	well-done	68 - 75 °C
Lamb shoulder	well-done	78 - 85 °C
<b>Poultry</b>		
Chicken	well-done	85 °C
Goose/Duck	well-done	90 - 92 °C
Turkey	well-done	80 - 85 °C
<b>Pastries etc</b>		
Pastries		72 - 85 °C
Terrines		60 - 70 °C
<b>Fish</b>		
Salmon	soft	60 °C
Fish fillet		62 - 65 °C
Entire fish		65 °C
Terrine		62 - 65 °C

## *Delayed start*

---

Use the 'delayed start' function to start cooking at a later time. The delayed start function can be selected via the 'Plus' menu in an oven function only. See the 'Using the 'Plus' menu' chapter.

### **Setting a delayed start time**

1. Select a function, temperature and set a cooking time if necessary (see 'Function-setting display' chapter).



*A delayed start time can also be set without setting a cooking time.*

2. Tap the 'plus' symbol to open the 'Plus' menu .
3. Tap on 'DELAYED START' to open the function.

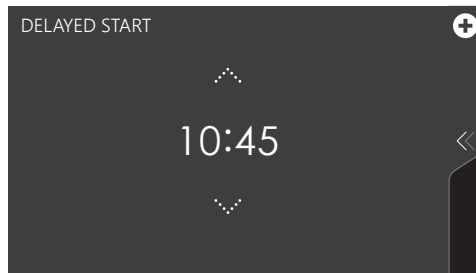

4. Select a start time (see 'Function-setting display' chapter)..
5. Confirm the set start time using the confirm key.  
The 'delayed start time' icon appears under the plus symbol to indicate activation. The delayed start time can be deselected by returning the setting to the current time.
6. Start cooking using the confirm key.



*The cooking will start automatically at the set time. If a cooking time has been set, the cooking will also stop automatically.*



- The following values can now be read in the display:
  - set temperature (180 °C)
  - start time (10:45)
  - end time (11:15) (only visible if a cooking time has been set!)

## Stage cooking

- Open the 'Stage cooking' menu via the 'Plus' menu. See the 'Using the 'Plus' menu' chapter.
- This function allows you to combine up to three functions in one cooking process.
- Select different functions and settings to compose the cooking process of your preference.

1. Tap the plus symbol to open the 'Plus' menu.
2. Tap 'STAGE COOKING' to open the function (can only be opened if no cooking process has started). The stage 1 settings are visible. These can be adjusted if desired.

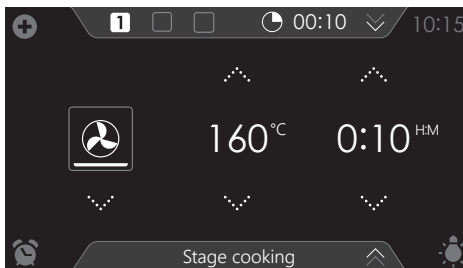

3. Select a function (see 'Function-setting display' chapter).
4. Select a temperature (see 'Function-setting display' chapter).
5. Select a cooking time (see 'Function-setting display' chapter).
6. Confirm the setting of stage 1 using the confirm key.



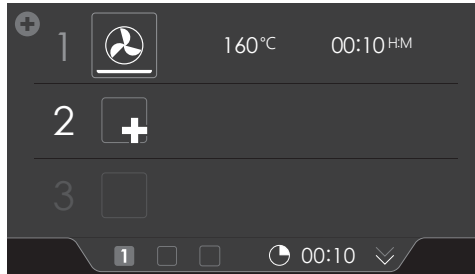

7. Tap on '2' to show the stage 2 settings.
8. If necessary, change the stage 2 default values (function, temperature and cooking time) (see points 3, 4 and 5).



9. Confirm the setting of stage 2 using the confirm key.

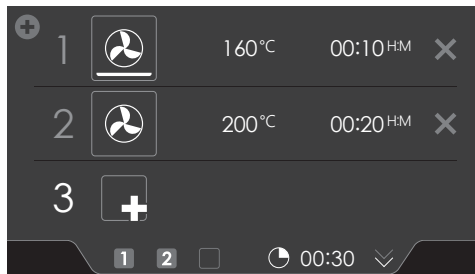

10. If desired, tap on '3' to show the stage 3 settings.
11. If necessary, change the stage 3 default values (function, temperature and cooking time) (see points 3, 4 and 5).
12. Confirm the setting of stage 3 using the confirm key.



*Delete a stage by tapping on the cross next to the settings. A stage can only be deleted if it has not yet started.*



13. By pressing the confirm key again, the oven starts to work according to stage 1 (the active stage is displayed in white). When the set time has elapsed, the following stage will be activated, this being stage 2 and later stage 3 if this has been set.

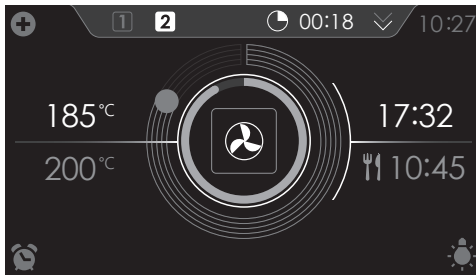

- The following values can now be read in the display:
  - active stage (2)
  - total cooking time (00:18)
  - current temperature (185 °C)
  - active stage set temperature (200 °C)
  - active stage status indicator time (outer circle)
  - active stage status indicator temperature (inner circle)
  - active stage cooking time (17:32)
  - total end time (10:45)



*The selected settings can be saved in 'Favourites'. For this open the 'ADD TO FAVOURITES' menu from the 'Plus' menu (See 'Saving a cooking method' in the 'Additional functions' chapter).*

## Additional functions

Several additional functions or programs can be selected.

1. Tap on 'EXTRAS' to show the appliance's extra functions.

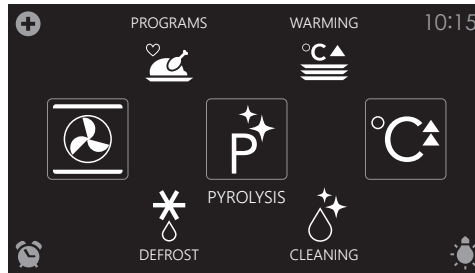

The following additional functions and programs can now be selected:

- Warming:
  - Plate warming
  - Keep warm
- Programs:
  - Favourites
  - Automatic programs

### **Warming**

- Plate warming
  - This function is used when you want to warm tableware (plates, cups) so that the served food stays hotter for longer.
  - By choosing this function you can determine the plate warming temperature and duration.
- Keep warm
  - Use this function to keep already cooked food at temperature.
  - By choosing this function you can determine the keep warm temperature and duration.

### **Selecting warming functions**

1. Tap on 'EXTRAS' to show the appliance's extra functions.
2. Tap on 'WARMING' to open the warming function menu.

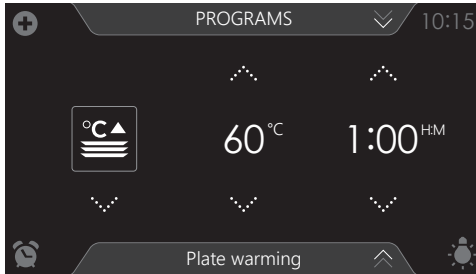

3. Choose the desired warming function (plate warming or keep warm). Adjust the settings if necessary (see 'Function-setting display' chapter).
4. Start the function using the confirm key.



### Programs:

- Favourites
  - You can select your own stored recipes in 'FAVOURITES'. See also 'Saving a cooking method'.
- Automatic programs
  - You can use 'automatic programs' for cooking by selecting a dish from a list of pre-programmed dishes. The programs are subdivided into categories (MEAT, VEGETABLES, etc.).
  - First select the category and then the dish itself from the available list.

### Selecting program functions

1. Tap on 'EXTRAS' to show the appliance's extra functions.
2. Tap on 'PROGRAMS' to open the programs menu.

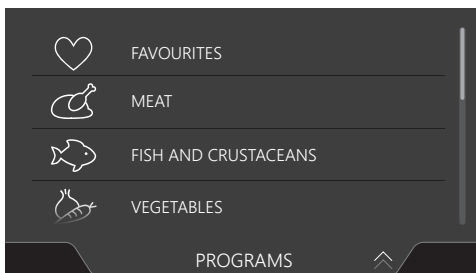

3. Tap on 'FAVOURITES' or one of the automatic program categories.
  - Select one of your saved dishes in 'FAVOURITES'.
  - Select a dish from the available list in the automatic programs.

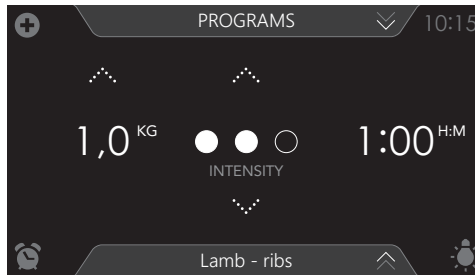
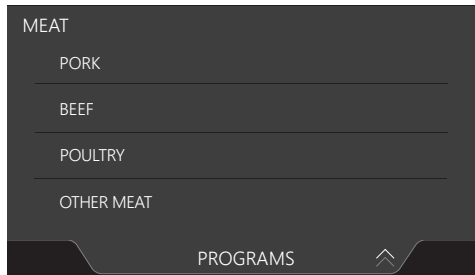

4. If necessary adjust the intensity and/or the weight.

*The intensity or weight cannot be adjusted in all automatic programs.*



5. Start the chosen dish using the confirm key.

- Open information about the chosen program using the info tab. Information about the required accessories and the shelf level in the oven can be read in this tab. Sometimes information about cooking the dish may also be found in this tab.
- For a number of automatic programs, it is sometimes possible to adjust settings manually. For adjusting the settings open the 'Plus' menu and tap 'MANUAL'.

## Saving a cooking method

A function/cooking method is active (the oven has started).

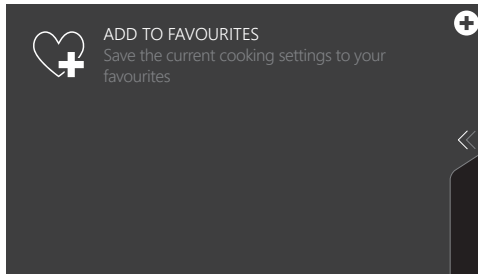

1. Open the 'Plus' menu and tap on 'ADD TO FAVOURITES'.

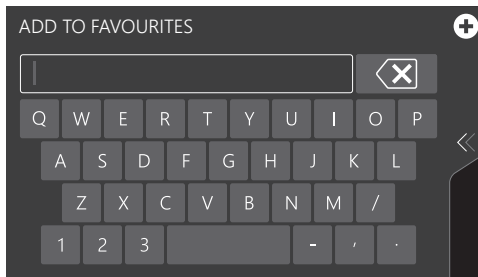

2. Give the dish you are preparing a name by selecting the appropriate letters. Tap on the 'arrow with cross' symbol if you wish to delete a letter.
3. Press on the confirm key to save the cooking method.



*Automatic programs can also be saved under 'FAVOURITES'.*

## Settings

---

1. From the start display, tap on the plus symbol.

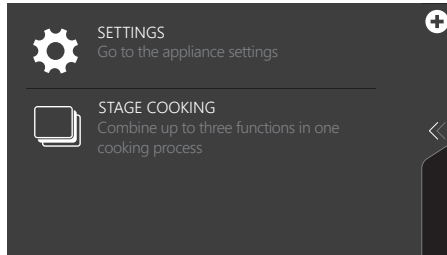

2. Tap on 'SETTINGS'.

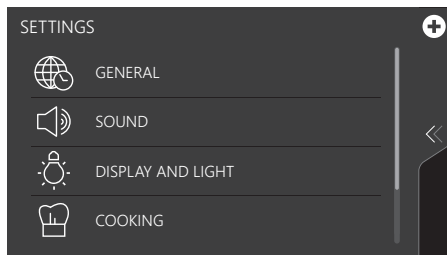

This menu offers the following choices:

- General
- Sound
- Display and light
- Cooking
- System

1. Tap on the desired category and the setting to be adjusted.
  - tap on the desired choice from a list
  - adjust a value by tapping the arrows above and below the value or swiping over the value
  - switch a setting on or off by tapping on 'ON' or 'OFF'
2. Press the confirm key to confirm.



## GENERAL

You can set the following from this menu:

- Language (language of the touch screen)
- Time (Current time)
- Time display (12 or 24 hour clock)
- Date (current date)
- Date display (date visible or not in the 'stand-by' display)

## SOUND

You can set the following from this menu:

- General sounds (volume of sound signals and alarms)
- Key sounds (volume of key sounds)
- Start-up/shut-down sound (volume of start-up/shut-down sound)

## DISPLAY AND LIGHT

You can set the following from this menu:

- Display brightness (adjustable in 5 brightness levels)
- Oven light (the time the light stays on after activation)
- Appliance to stand-by setting (the length of time before the appliance goes to stand-by after the last operation)
- Appliance switch off (how long the appliance stays in stand-by)
- Start-up/shut-down animation (start-up/shut-down of the brand animation)
- Night mode (start and end time for lower display brightness)



*When for 'APPLIANCE SWITCH OFF' setting 'Manual' is selected, the appliance does not switch off automatically. When the device is switched off manually, this setting is put back to the factory setting. This is a mandatory maximum energy consumption regulation.*

## COOKING

You can set the following from this menu:

- Default program intensity (intensity of automatic programs)

## SYSTEM

You can set the following from this menu:

- Appliance information (request appliance information)
- Factory settings (back to factory settings)

# CLEANING

## Cleaning the appliance

Clean the oven regularly to prevent fat and food particles from accumulating, especially on the surfaces of the interior and the exterior, the door and the seal.

- Activate the child lock (to prevent that the appliance is switched on accidentally).
- Clean the exterior surfaces with a soft cloth and warm soapy water.
- Next wipe with a clean, damp cloth and dry the surfaces.
- Remove splashes and stains on the interior surfaces with a cloth and soapy water.
- Next wipe with a clean, damp cloth and dry the surfaces.



- **Make sure that no water enters the vents.**
- **Never use abrasive cleaning materials or chemical solvents.**
- **Always make sure that the seal of the door is clean. This prevents accumulation of dirt and allows you to close the door properly.**

## Steam clean

With the steam clean and a damp cloth, you can easily remove grease and dirt from the oven walls.

### **Using steam clean**

Only use steam clean when the oven has cooled down fully. It is more difficult to remove dirt and grease if the oven is hot.

Remove all accessories from the oven.

1. Pour 0.15 litres of water into the bottom of the oven.
2. Tap on 'EXTRAS' to show the appliance's extra functions.
3. Tap on 'CLEANING' to open the cleaning function.
4. Press on the confirm key to start steam clean.



- *Do not open the door during the cleaning process.*
- *The process takes 30 minutes.*  
*Food remains on the enamel walls will be sufficiently soaked after 30 minutes so they can be removed with a damp cloth.*



## Pyrolysis

---

Instead of cleaning manually, you can clean the oven space or an enamelled baking tray using the 'Pyrolysis' oven feature. During pyrolysis the oven space is heated to a very high temperature. Contaminants that are present incinerate at this high temperature and only ash remains.



With average use of the oven, we recommend running the pyrolysis function once per month.



### Caution!

- First, remove all accessories and guide rails / telescopic guide rails from the oven (see 'Removing and cleaning the guide rails').
- Then remove any remaining food from the oven space and wipe the space with a damp cloth. Chunks of food and fat may ignite during the pyrolysis process. **Fire hazard!**



**Note!** The oven space and an enamelled baking tray cannot be cleaned at the same time using the pyrolysis function. If you want to clean an enamelled baking tray using pyrolysis, then do this first (the oven space can become dirty due to the cleaning of the baking tray). Insert one baking tray at a time. After that, the oven space can be cleaned.



**Caution!** Do NOT clean the glass baking tray using the 'Pyrolysis' oven feature.

### Starting the Pyrolysis function

1. Make sure the oven space is completely empty and no chunks of food and fat are present!
2. If you want to clean an enamelled baking tray first, place the special pyrolysis guide rails in position. Wipe the baking tray with a damp cloth and slide the baking tray into the oven on Level 2.
  - Remove these special pyrolysis guide rails after the cleaning process.
3. Tap on 'EXTRAS' to show the appliance's extra functions.
4. Tap on 'PYROLYSIS' to open the pyrolysis function.

## CLEANING

5. Select the desired cleaning intensity:
  - ▷ Low: approximately 3 hours
  - ▷ Average: approximately 3,5 hours
  - ▷ High: approximately 4 hours



*Only the cleaning intensity can be selected. The time is fixed and depends on the selected cleaning intensity.*



6. Press on the confirm key to start pyrolysis clean.
  - After a certain period the oven door will be locked automatically for your own safety.
  - An unpleasant smell may be released from the oven during the cleaning process.
  - The oven door can be opened once the appliance has cooled down (after the end of the pyrolysis cleaning).
  - When the oven has cooled down, wipe with a damp cloth. Wipe the oven door and the adjacent surfaces around the door seal. Do not rub the seal.

### Removing and cleaning the guide rails

Use conventional cleaning products to clean the guide rails.

- Remove the screw using a screwdriver.
- Remove the guide rails from the holes in the back wall.

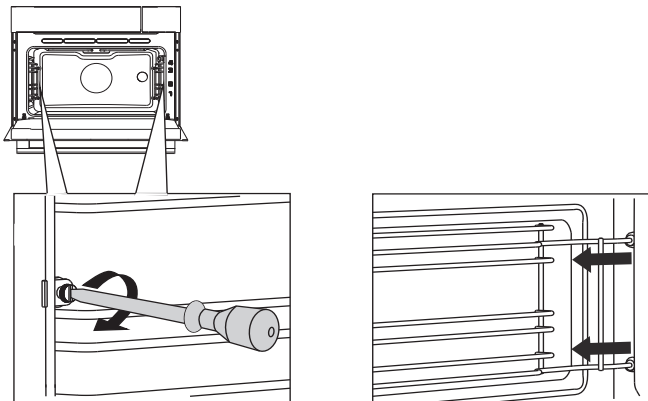

## Replacing the oven light bulb



**The lamp in this household appliance is only suitable for illumination of this appliance. The lamp is not suitable for household room illumination.**

The light bulbs (2x) (halogen G9, 230 V, 25 W) are a consumer items and therefore not covered by warranty. To replace it, first remove the baking tray, oven rack and guide rails.



**Disconnect the appliance from the power supply by removing the plug from the socket or by switching off the circuit breaker in the fuse box.**



**Please note: the light bulb can be very hot! Use protection to remove the bulb.**

1. Use a flat-blade screwdriver to snap and remove the lamp cover from the holder. Be careful not to damage the enamel.
2. Take the halogen light bulb out of the fitting.

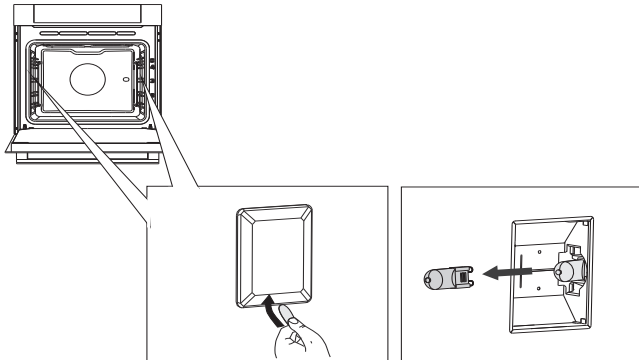

## Removing the oven door



**Keep your fingers away from the hinges of the oven door. The hinges are spring loaded and can cause injury if they spring back. Make sure that the hinge latches are applied correctly to lock the hinges.**

### **Remove the oven door.**

1. Open the door to the fully open position.
2. Lift both hinge latches (A) and pull them towards the oven door (B).  
*The hinges will be locked in the 45° position.*
3. Gently close the door until it reaches a 45° angle.
4. Remove the door by lifting and tilting it towards the oven (C). The hinges need to come out of the slots in the oven.

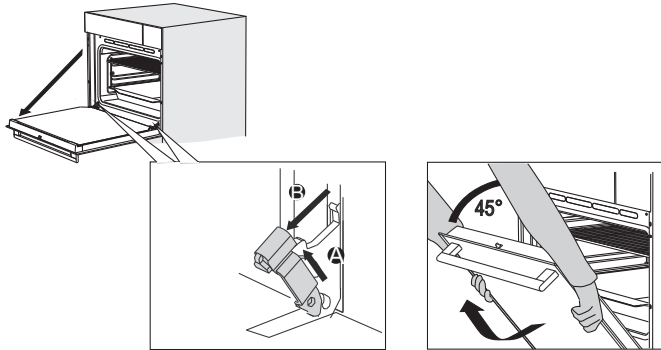

### **Install the oven door**

1. Hold the door at an angle of approximately 45° in front of the oven.
2. Insert the hinges into the slots and make sure they are both positioned correctly.
3. Open the door to the fully open position.
4. Lift both hinge latches and move them towards the oven.
5. Gently close the oven door and make sure that it closes correctly.  
*If the door does not open or close correctly, then make sure that the hinges are positioned correctly in their slots.*

## CLEANING

### Removing the oven door glass

The inside of the glass in the oven door can be cleaned. For this it must be removed from the oven door.

1. Slightly lift (1) and shift (2) the clamps at the lower left and right of the door to release the glass (A).
2. Grab the glass (A) at the bottom and gently lift (3) and shift (4) it to remove it from the upper support.
3. The inner glass (B) (depending on the model) can be removed by carefully lifting (5) and shifting (6) it to removing it from the lower support. Also remove the rubber spacers (C) from the inner glass.

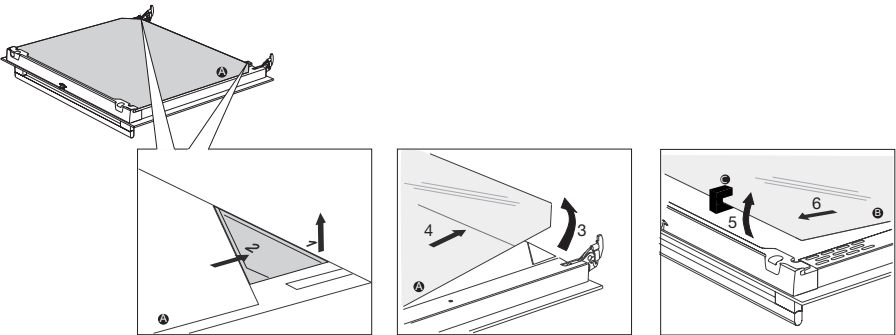

Install the glass in reverse order.

## *General*

---

If you have problems with your oven, then consult the error overview below. Should the problems persist, then please contact the Customer Services Department.

### **The food stays raw**

- Check whether the timer has been set and you have pressed the confirm key.
- Is the door closed properly?
- Check whether a fuse has blown and whether a circuit breaker has been activated.

### **The food is overcooked or undercooked**

- Check whether the correct cooking time has been set.

### **The sensors don't respond; the display is locked.**

- Disconnect the appliance from the power supply for a few minutes (unscrew the fuse or switch off the mains); then reconnect the appliance and switch it on.

### **Power failure can cause the display to reset.**

- Disconnect the appliance from the power supply for a few minutes (remove the mains plug from the socket or switch the circuit breaker to off); then reconnect the appliance and switch it on.
- Set the time again.

### **There is condensation in the oven.**

- This is normal. Wipe the oven clean after use.

### **The fan keeps working after the oven is switched off.**

- This is normal. The fan will keep working for a while after the oven is switched off.

### **Air flow can be felt at the door and the exterior of the appliance.**

- This is normal.

### **Steam escapes via the door or the vents.**

- This is normal.

**Clicking sounds can be heard when the oven is working, particularly in the defrost setting.**

- This is normal.

**The circuit breaker switches off regularly.**

- Consult a service technician.

**The display gives an error code, ERROR XX ...**

*(XX indicates the number of the error).*

- There is a fault in the electronic module. Disconnect the appliance from the power supply for a few minutes. Then reconnect it and set the current time.
- Consult a service technician if the error persists.

**Storing and repairing the oven**

Repairs should only be performed by a qualified service technician.

If maintenance is required, take the plug from the socket and contact the ATAG customer service.

**Have the following information to hand when you call:**

- The model number and serial number (stated on the inside of the oven door)
- Warranty details
- A clear description of the problem



**Choose a clean, dry place if you have to store the oven temporarily, as dust and moisture can damage the appliance.**

## Disposal of the appliance and packaging

This product is made from sustainable materials. However, the appliance must be disposed of responsibly at the end of its useful life. The government can provide you with information about this.

The packaging of the appliance can be recycled. The following materials have been used:

- cardboard
- polyethylene wrap (PE)
- CFC-free polystyrene (hard PS foam)

Dispose of these materials responsibly in accordance with legal provisions.



The product has a pictogram of a rubbish bin with a cross through it. This indicates that household appliances must be disposed of separately. This means that the appliance may not be processed via the regular waste flow at the end of its useful life. You should take it to a special municipal waste depot or a sales outlet that offers to do this for you.

Collecting household equipment separately prevents harm to the environment and public health. The materials used in manufacturing this appliance can be recycled, which provides considerable savings in energy and raw materials.

### **Declaration of conformity**

















We hereby declare that our products comply with the relevant European directives, standards and regulations as well as all requirements referred to in the standards.



# COOKING TEST

## Food tested in compliance with the EN 60350-1 standard

### ZX6574M

<b>Baking</b>					
Dish	Equipment	Guide (from the bottom)	Temperature (°C)	Cooking time (min)	System
Shortbread - single level	Shallow enamel-coated baking tray	3	140-150 *	20-35	
Shortbread - single level	Shallow enamel-coated baking tray	3	140-150 *	25-40	
Shortbread - two levels	Shallow enamel-coated baking tray	2, 3	140-150 *	25-40	
Shortbread - three levels	Shallow enamel-coated baking tray	2, 3, 4	130-140 *	30-50	
Cupcakes - single level	Shallow enamel-coated baking tray	3	140-150 *	20-35	
Cupcakes - single level	Shallow enamel-coated baking tray	3	150-160 *	20-35	
Cupcakes - two levels	Shallow enamel-coated baking tray	1, 3	140-150 *	30-45	
Cupcakes - three levels	Shallow enamel-coated baking tray	2, 3, 4	140-150 *	35-50	
Sponge cake	Round metal mould, diameter 26 cm/Oven rack	2	160-170 *	20-35	
Sponge cake	Round metal mould, diameter 26 cm/Oven rack	2	160-170 *	20-35	
Apple pie	2 x round metal mould, diameter 20 cm/Oven rack	2	170-180	65-85	
Apple pie	2 x round metal mould, diameter 20 cm/Oven rack	3	160-170	65-85	
<b>Grilling</b>					
Dish	Equipment	Guide (from the bottom)	Temperature (°C)	Cooking time (min)	System
Toast	Oven rack	5	240	3:00-6:00	
Beefburgers	Oven rack + baking tray as drip tray	5	240	25-35 **	













\* Preheat for 10 minutes. Do not use fast preheat function.

\*\* Turn after 2/3 of the cooking time.

# COOKING TEST

## Food tested in compliance with the EN 60350-1 standard

### ZX4574MN

<b>Baking</b>					
Dish	Equipment	Guide (from the bottom)	Temperature (°C)	Cooking time (min)	System
Shortbread - single level	Shallow enamel-coated baking tray	2	140-150 *	25-40	
Shortbread - single level	Shallow enamel-coated baking tray	2	140-150 *	25-40	
Shortbread - two levels	Shallow enamel-coated baking tray	2, 3	140-150 *	25-40	
Cupcakes - single level	Shallow enamel-coated baking tray	2	140-150 *	20-35	
Cupcakes - single level	Shallow enamel-coated baking tray	2	150-160 *	20-35	
Cupcakes - two levels	Shallow enamel-coated baking tray	2,3	140-150 *	30-45	
Sponge cake	Round metal mould, diameter 26 cm/Oven rack	1	160-170 *	20-35	
Sponge cake	Round metal mould, diameter 26 cm/Oven rack	1	160-170 *	20-35	
Apple pie	2 x round metal mould, diameter 20 cm/Oven rack	1	170-180	65-85	
Apple pie	2 x round metal mould, diameter 20 cm/Oven rack	2	160-170	65-85	
<b>Grilling</b>					
Dish	Equipment	Guide (from the bottom)	Temperature (°C)	Cooking time (min)	System
Toast	Oven rack	4	240	3:00-6:00	
Beefburgers	Oven rack + baking tray as drip tray	4	240	25-35 **	

\* Preheat for 10 minutes. Do not use fast preheat function.

\*\* Turn after 2/3 of the cooking time.





The appliance identification card is located on the inside of the appliance.

When contacting the service department,  
have the complete type number to hand.

You will find the addresses and phone numbers of the service organisation on the  
guarantee card.

# ATAG



596459