

VA68I INT

Operating Instructions

Dishwasher

VA68I INT

Dear ATAG customer!

We hope that you will have many years of use from your new machine.

The machine has many features. To make the most of its functions, we recommend that you read the operating instructions before using the machine. The operating instructions include information on how you can help protect the environment.

ATAG

CONTENTS

FRONT PANEL	2	TROUBLESHOOTING	15
SAFETY INSTRUCTIONS	3	INFORMATION FOR TEST INSTITUTE	18
BEFORE WASHING FOR THE FIRST TIME	4	TECHNICAL INFORMATION	19
LOADING THE DISHWASHER	5	INSTALLATION	20
USING THE DISHWASHER	7	SERVICE	21
SETTINGS	10	PROGRAMME CHART	22
CARE AND CLEANING	13	YOUR NOTES	23

FRONT PANEL

The panel is fitted with touch buttons with audible feedback (see the chapter Settings).

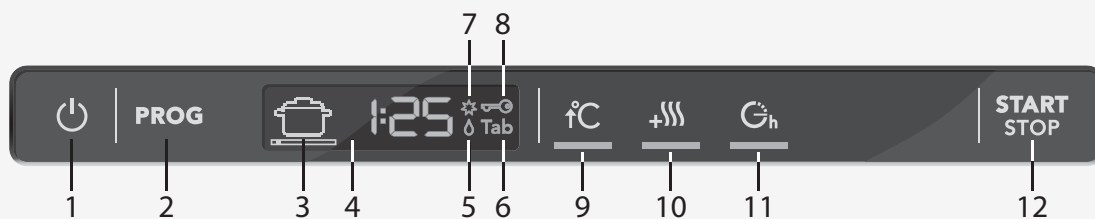

1 On/Left-on mode	5 Rinse aid indicator	9 High temperature
2 Programme selector	6 TAB (3-in-1/all-in-one detergent)	10 Long dry
3 Programme symbol	7 Salt indicator	11 Delayed start
4 Display	8 Child lock (button lock)	12 Start/Stop

NOTE!

- Two minutes after the last button press, the panel backlight enters energy saving mode. Close and reopen the door, or press the On/Left-on mode button, to reactivate the panel.

SAFETY INSTRUCTIONS

GENERAL

- Read the operating instructions and keep them in a safe place!
- Never use the dishwasher for any purpose other than that specified in these operating instructions.
- Do not load the dishwasher door or dishwasher baskets with anything other than dishes.
- Never leave the dishwasher door open as someone may trip on it.
- Use only dishwasher detergent!
- Place knives and other sharp items so that they cannot harm anyone or damage the dishwasher.
- The machine is not designed to be used by persons (even children) that are physically or mentally handicapped or lack experience and knowledge. Such persons must receive instruction in how to use the machine from the person responsible for their safety.
- Children must be watched to ensure they do not play with the dishwasher.
- Damaged mains cables must only be replaced by a qualified electrician.
- This dishwasher is for household or similar use, such as:
 - staff kitchens in shops, offices and other workplaces.
 - farms.
 - for guests at hotels, motels and other types of accommodation.
 - bed & breakfast hotels.
- Never place dishes with solvent residues in the dishwasher due to the risk of explosion. Nor may dishes that contain ash, wax or lubricants be washed in the dishwasher.

INSTALLATION

See the section Installation.

CHILD SAFETY

- Use the knife stand for all long/sharp items.
- Always close the door and start the programme immediately after you have added the detergent.
- Keep children away from the dishwasher when the door is open. Some detergent may remain inside!
- Do not allow children to use or play with the dishwasher. Be especially vigilant when the door is open.

WARNING!

Children must be supervised – dishwasher detergent is corrosive!

Store detergent and rinse aid out of the reach of children! If anyone swallows dishwasher detergent, they should immediately drink one or two glasses of milk or water. Do not attempt to induce vomiting. Contact a doctor! If anyone gets dishwasher detergent in their eyes, rinse (for at least 15 minutes) with plenty of water.

Activate child lock (button lock)

You can activate the child lock (button lock) to prevent children from starting the dishwasher (see the section Settings).

WINTER STORAGE/TRANSPORT

- Store the dishwasher where the temperature remains above freezing.
- Avoid long transport distances in very cold weather.
- Transport the dishwasher upright or laying on its back.

OVERFLOW GUARD FUNCTION

The overflow protection starts pumping out the machine and turns off the water supply if the water level in the dishwasher exceeds the normal level. If the overflow protection is triggered, turn off the water supply and call the service division.

CLEANING

When cleaning the edge around the door, use only a slightly damp cloth. Do not spray water around the edge! Moisture can make its way into the lock, which contains electrical components.

PACKING MATERIAL

Please sort waste materials in accordance with local guidelines.

DISPOSAL

- When the dishwasher has reached the end of its service life and is to be disposed of, it should immediately be made unusable. Pull out the power cable and cut it as short as possible.
- The dishwasher is manufactured and labelled for recycling.
- Contact your local authority for information about where and how your dishwasher should be correctly recycled.

BEFORE WASHING FOR THE FIRST TIME

PROGRAMME KEY

Some dishwashers include programme keys in different languages. Attach the programme key in the desired language to the top of the door.

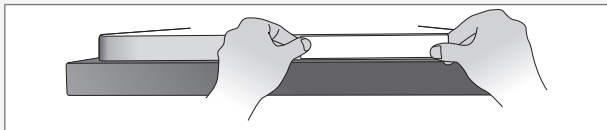

THE WATER SOFTENER

In order to achieve good dishwashing results, the dishwasher needs soft water (water with low mineral content). Hard water leaves a white coating on dishes and the dishwasher.

Water hardness is specified using the following scales: The German water hardness scale (°dH) and the French water hardness scale (°fH). A water supply with a water hardness in excess of 6°dH (9°fH) must be softened. This is done automatically with the aid of the built-in water softener. In order for the softener to function optimally, it must be adjusted to the hardness of the water supply.

Contact the local waterworks to check the water hardness in your area. Once you have adjusted the water softener, use detergent and rinse aid doses suitable for soft water.

ADJUSTING THE WATER SOFTENER

Chapter Settings, page 12 describes how to adjust the water softener. Don't forget to fill the salt compartment with salt after adjusting the water softener.

FILL UP THE SALT

Before you begin using a dishwasher with a water softener, you must fill the salt compartment with salt. Use large grain salt or special dishwasher salt.

WARNING!

Top up the salt just before running a programme. To avoid the risk of rust stains, the dishwasher must be rinsed immediately after topping up the salt.

WARNING!

Never pour dishwasher detergent into the salt compartment. This destroys the water softener!

Do as follows the first time:

- 1 Unscrew the lid as illustrated.
- 2 Place the funnel supplied with the dishwasher in the salt compartment top-up hole. First, pour in about 1 l of water.
- 3 Then add salt, a maximum of 1.5 kg, until the compartment is full.
- 4 Wipe up any excess salt so that the lid can be screwed on firmly.
- 5 Run a programme to ensure that any salt in the dishwasher is rinsed away.

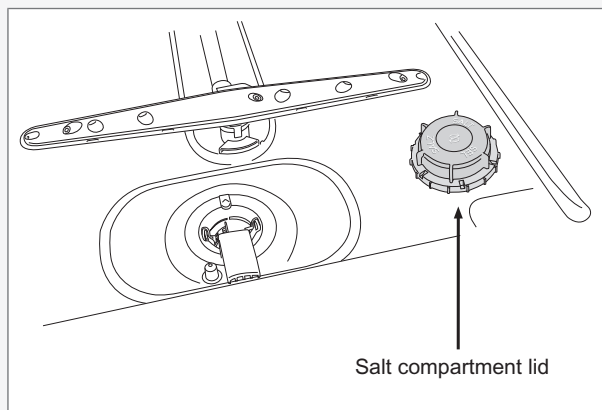

REFILL SALT INDICATOR

When the salt needs topping up, the above symbol lights on the display.

When the salt runs out, unscrew the cap and fill the container with salt. Water is only needed the first time! Wipe clean and tighten. Run a programme to ensure that any salt in the dishwasher is rinsed away.

NOTE!

After topping up, it may take a while before the symbol goes out.

TOP UP WITH RINSE AID

Drying is faster if you use rinse aid.

- 1 Open the rinse aid compartment lid.
- 2 Carefully top up with rinse aid. Only add rinse aid to the level marked max.
- 3 Wipe up any splashes of rinse aid around the compartment.
- 4 Close the lid firmly.

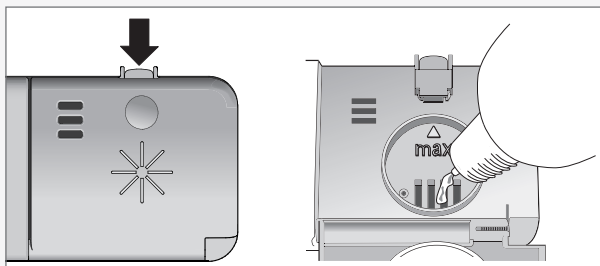

LOADING THE DISHWASHER

SELECTING THE RINSE AID DOSAGE

Rinse aid dispensing can be set from **0** (Off) to **5** (High dose). (Factory settings: **3**)

Increase the rinse aid dosage:

- If the dishes have water marks.

Reduce the rinse aid dosage:

- If the dishes have a sticky white/blue film.
- If the dishes are streaked.
- Build-up of foam. If you have very soft water, the rinse aid can be diluted 50:50 with water.

SETTING THE RINSE AID DOSAGE

The section Settings describes how to set the rinse aid dosage.



REFILL RINSE AID INDICATOR

When the rinse aid needs topping up, the above symbol lights on the display.

NOTE!

After topping up, it may take a while before the symbol goes out.

ECONOMIC DISHWASHING

Run programmes only with a full load

Wait to run a programme until the dishwasher is full, this way you save energy. Use the Rinse & Hold programme to rinse the dishes if there are any unpleasant odours while you wait for the dishwasher to become fully loaded.

Run programmes at a lower temperature

If the dishes are only slightly dirty, you can select a lower temperature with certain programmes. See also the section Selecting Options in the chapter Using the dishwasher.

Do not rinse under running water

Simply scrape off large food particles before loading the dishwasher.

Choose a green detergent

Read the environmental declaration on the packaging!

Connect to cold water...

If you use oil or electricity to heat your home.

Connect to hot water (max. 70 °C)...

If you use district heating, solar power or geothermal power to heat your home. Choosing a hot water connection cuts programme times and reduces the dishwasher's electricity consumption.

FRAGILE DISHES

Some cookware is not dishwasher safe. This can be for several reasons. Some materials cannot withstand strong heat, others can be damaged by dishwashing detergent.

Fragile decoration

Porcelain with decoration on top of the glazing (the items feel rough) should not be washed in a dishwasher.

Crystal/Glass

Position items so that they do not touch each other during the wash. Use the lowest possible wash temperature and the shortest possible programme. Select Short dry. Antique and very fragile items should not be washed in a dishwasher.

Glass washed in a dishwasher at high temperatures can gradually develop a grey film that cannot be removed. Wash fragile glasses at a low temperature and with a small amount of detergent.

Silver

Silver and stainless steel items should not come into contact, as the silver can become discoloured.

Cutlery with glued handles

Some types of glue are not dishwasher safe. In such cases, the handles may loosen.

Wood

Wooden items should only be washed in a dishwasher if marked dishwasher safe.

Aluminium

Aluminium can lose its shine if washed in a dishwasher. However, good quality aluminium pans can be washed in a dishwasher, even if some of the shine will be lost.

Plastic items

Avoid washing plastic items that cannot withstand high temperatures.

UPPER BASKET

Place glasses, cups, bowls, side plates and saucers in the upper basket. Wine glasses are placed on the wine glass shelf and knives are placed in the knife stand on the right (if fitted).

NOTE!

All dirty surfaces should face inwards and downwards!

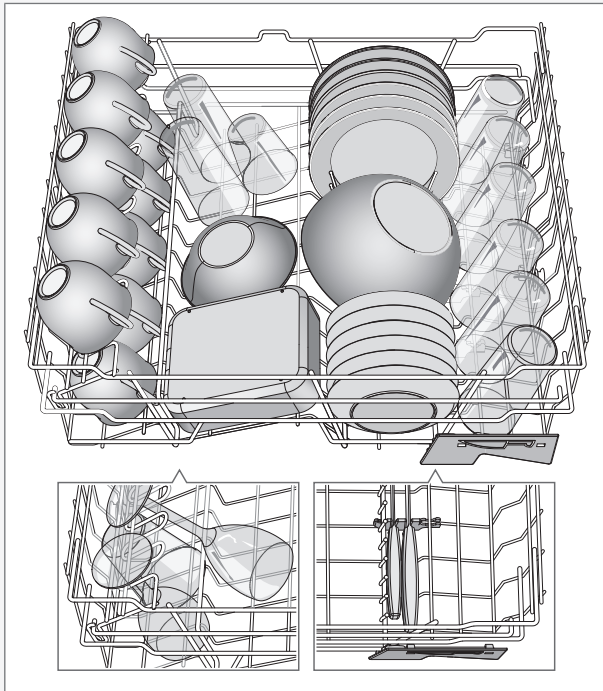

LOWER BASKET

Place plates, side plates, serving dishes, pots and cutlery (in the cutlery basket) in the lower basket.

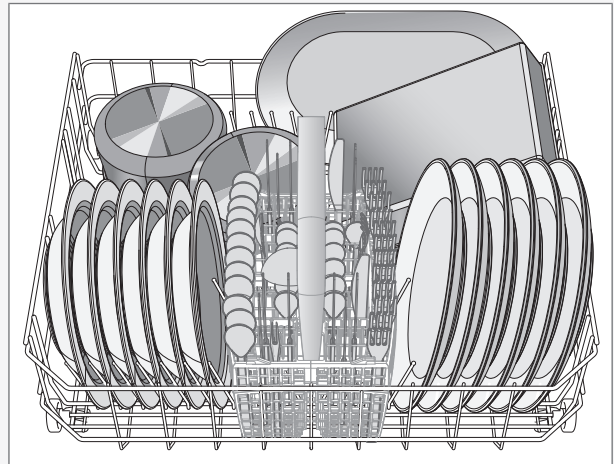

CUTLERY BASKET

Place cutlery with the handles facing down, except for knives, and spread them out as much as possible. Ensure that spoons do not stack inside each other.

The cutlery basket is placed in the lower basket.

NOTE!

Do not place cutlery made of different materials, such as silver and stainless steel, in the same place (risk of discolouration).

! WARNING!

Knives and other pointed items must be placed with the points down in the cutlery basket or horizontally in other baskets.

Fold-down section for small items

The cutlery basket has a fold-down section in the middle for small items, or small shafts, such as electric whisk attachments.

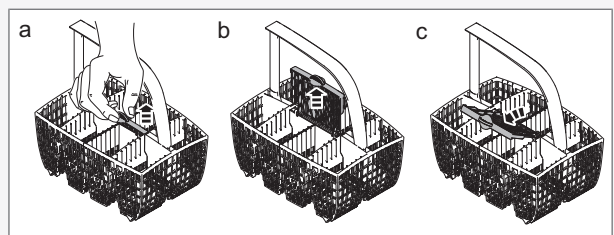

Cutlery basket with lid

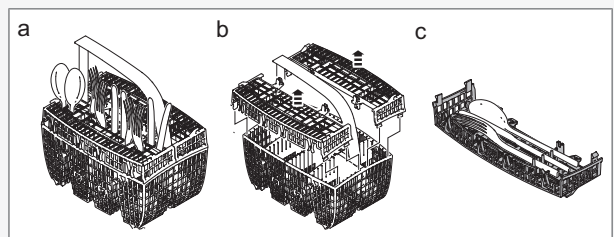

USING THE DISHWASHER

Positioning of cutlery basket lid (in upper basket)

The cutlery basket lid can be removed and used, for example, as an extra cutlery basket in the upper basket (see below).

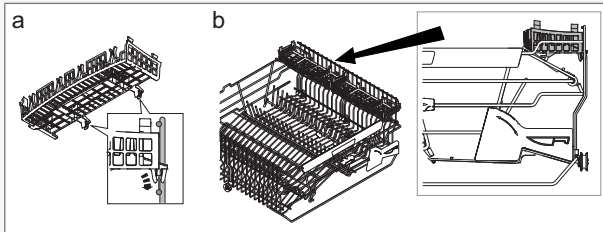

ADD DETERGENT

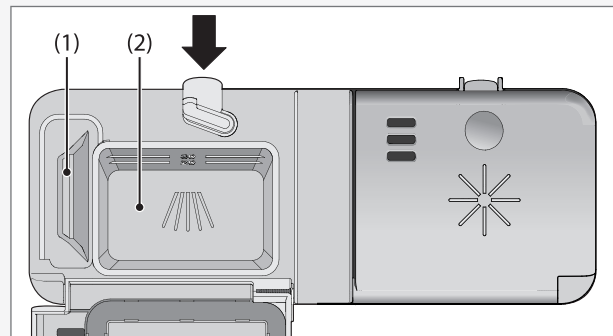

- 1 Prewash detergent compartment
- 2 Main wash detergent compartment

Detergent is added according to water hardness.

Follow the instructions on the detergent packaging. This dishwasher is fitted with a water softener, so use detergent and rinse aid doses suitable for soft water.

Too much detergent can result in less effective dishwashing and also entails greater environmental impact.

Add the detergent to the detergent compartment. There is one compartment for the prewash and one for the main wash. If tablets are not used, add a small amount of the detergent to the prewash compartment. Contact the detergent manufacturer if you have any questions about the detergent.

WARNING!

Children must be supervised – dishwasher detergent is corrosive!

NOTE!

Use only dishwasher detergent! Washing up liquid must not be used as the foam that forms prevents the dishwasher from operating effectively.

Dishwasher tablets

Halve the tablet if it is difficult to close the dispenser lid. There is a risk that the detergent will not be released properly if the lid is tight and will not open correctly.

NOTE!

Dishwasher tablets are not recommended for short programmes (less than 75 minutes). Use powder or liquid dishwasher detergent instead.

3-in-1/All-in-one detergent

Read through the directions for these products carefully. If anything is unclear, contact the detergent manufacturer.

PROGRAMME SELECTION

Press the Programme selector one or more times until the desired programme symbol appears on the display.

Auto **Auto wash**

The dishwasher can measure how dirty the dishes are and adjust water consumption and temperature accordingly. When newly installed, the programme needs to be run five times before it is fully adapted and can provide the best results.



Heavy wash

Programme for very dirty dishes, such as pans, casserole dishes and oven dishes. If these dishes do not completely fill the dishwasher, you can add plates and the like.



Normal wash

Powerful programme for daily use that can remove dried leftovers, but is not intended for burnt food, such as on oven dishes. This programme provides maximum rinse effect, and takes longer than Daily wash.



Daily wash

This is also an effective programme for daily use for slightly dried leftovers, but is not intended for burnt food, such as on oven dishes.



Quick wash

This programme is used for glasses and porcelain that is slightly dirty, such as coffee cups.



Super quick wash

Short programme lasting about 15 minutes with acceptable results for very slightly dirty dishes.



Delicate wash

If the dishes are not very dirty, you can select Delicate wash. This programme is intended for glasses and porcelain that have just been used and as such do not require such a powerful programme.

This programme can be used for fragile dishes. Select Short dry if you want to be especially cautious. See also the section Fragile dishes in the chapter Loading the dishwasher.

Eco **Eco wash**

This programme is intended for cleaning normally dirty dishes and is the most effective programme in terms of combined energy and water consumption.

The High temperature option must be selected to access the programme used to compile the information for energy labelling.



Rinse & Dry

This programme comprises a rinse with heating and drying. This is a suitable programme if, for example, you plan to make jam and want to rinse and heat clean glass jars.



Rinse & Hold

Used to rinse dishes while you wait for the dishwasher to become fully loaded.

SELECTING OPTIONS

To select an option, press one of the option buttons. The field under the button lights when the option is activated. The available options depend on the selected programme. Once you have started the programme, the options you selected are saved for the next time you use the same programme. An exception is the Delayed start option.



High temperature

Activate this option for improved dishwashing results. The machine then uses a higher temperature for the main wash.

If you want to use the lower temperature, press again so that the field under the button turns off.

You can vary the temperature as shown below:

	Heavy wash:	55 °C / 70 °C
	Normal wash:	60 °C / 65 °C
	Daily wash:	60 °C / 65 °C
	Quick wash:	30 °C / 60 °C
	Super quick wash:	30 °C / 60 °C
	Delicate wash:	40 °C / 50 °C
Eco	Eco wash:	50 °C / 60 °C



Long dry

A higher temperature in the final rinse and a longer drying phase improves the drying result if you activate the Long dry option. This causes a slight increase in energy consumption. This option can be used with all programmes except Rinse & Dry and Rinse & Hold.

If you want a programme with Short dry, press again so that the field under the button turns off.

Delayed start

When you select Delayed start, the dishwasher will start 1-24 hours after you press the Start/Stop button.

- 1 Press the button once to activate Delayed start. Press the button several times – or hold it in – to set the desired number of hours.
- 2 Press Start/Stop and the dishwasher counts down 1 hour at a time and starts after the selected delay.

Press and hold Start/Stop for three seconds if you want to cancel the Delayed start option.

NOTE!

Remember to press the Start/Stop button to start the programme.

START THE DISHWASHER

Press and hold Start/Stop until the display shows  (the door open symbol). This indicates that the dishwasher is ready to start. Close the door properly, otherwise the dishwasher will not start.

NOTE!

If the machine does not start within 2 minutes of the last button press, the display returns to showing the last programme run.

TIME REMAINING

Once you have selected a programme and options, the display indicates how long the programme took the last time it was used. The remaining time is updated after the water for the final rinse has been heated.

This may differ somewhat from time to time depending on the temperature of the water supply, the amount of dishes, the ambient temperature and other factors.

NOTE!

During the first run of each programme, the remaining time displayed can be slightly misleading, as the dishwasher is estimating the time. When you run the programme a second time, the dishwasher will calculate the remaining time based on the previous duration of the programme.

STOPPING OR CHANGING A PROGRAMME

If you want to change programme after starting the dishwasher, open the door then press and hold Start/Stop for three seconds. Add more detergent if the lid of the detergent dispenser has opened. Then choose a new programme, press Start/Stop and close the door.

DO YOU WANT TO ADD MORE DISHES?

Open the door. The dishwasher stops automatically. Add the dishes, close the door and the dishwasher continues the programme.

IF THE DISHWASHER IS TURNED OFF USING THE ON/LEFT-ON MODE BUTTON OR DUE TO A POWER FAILURE

If the dishwashing programme was not finished, the interrupted programme continues when power is restored.

NOTE!

During drying, the programme is interrupted if the power is cut or the door is open for more than 2 minutes.

ONCE THE PROGRAM HAS FINISHED

Once the programme has finished and the door is opened "End" appears on the display.

A buzzer also sounds at the end of the programme. See the section Settings, which describes how to change this function.

Once the dishwasher has finished, it uses only standby power. Turn off the water supply valve after each use.

SETTINGS

DO AS FOLLOWS TO OPEN THE SETTINGS MENU:



1. First, open the door. Turn off the dishwasher using the On/Left-on mode button (press and hold). Release the button.
2. Press and hold the On/Left-on mode button until the display lights up.
3. Within five seconds, press and hold the Programme selector and the Long dry button.
4. Release the buttons when the display shows SET.

PROG +





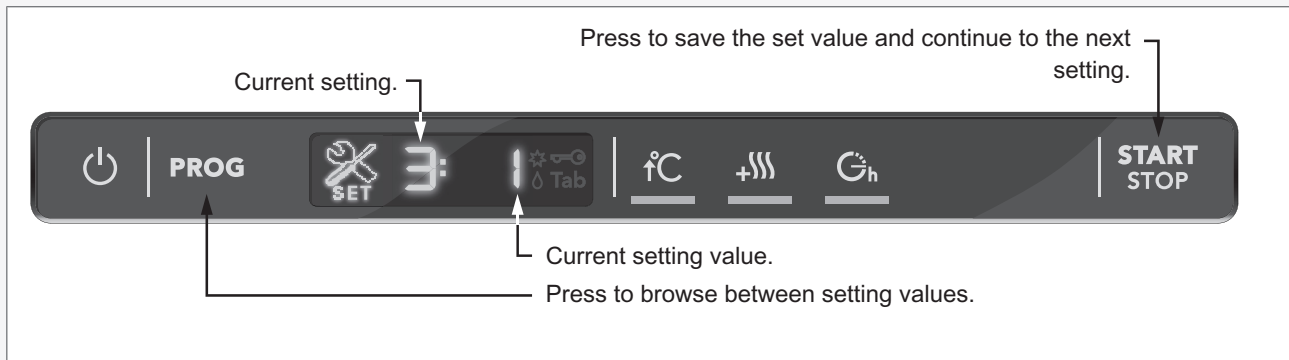

TIP!



Be sure to press right on the symbols, so as not to inadvertently activate any other button. Try again if you fail to open the settings menu the first time.



YOU CAN NOW ADJUST THE FOLLOWING SETTINGS:

Button press	Options	Settings	Description
PROG	<ul style="list-style-type: none"> ☐ (Off) 1 (On) 	Child lock (button lock)	<p>You can activate the child lock (button lock) option to prevent children from starting the dishwasher.</p> <p>Press the High temperature and Long dry buttons simultaneously to temporarily deactivate the button lock when you want to start the dishwasher. The button lock is automatically reactivated after 2 minutes.</p> <p></p>
START STOP	Press Start/Stop to save the setting value and continue to the next setting.		
PROG	<ul style="list-style-type: none"> ☐ (Off) 1 (Low) 2 3 4 (High) 	Buzzer volume	The dishwasher uses a buzzer to indicate when a programme is finished or when a fault has occurred.
START STOP	Press Start/Stop to save the setting value and continue to the next setting.		
PROG	<ul style="list-style-type: none"> ☐ (Off) 1 (Low) 2 3 4 (High) 	Operation volume	This sound is used to confirm each button press.

Button press	Options	Settings	Description
START STOP 	Press Start/Stop to save the setting value and continue to the next setting.		
PROG 	S: 1 (Low)	LCD contrast	For adjusting the contrast of the display on the panel.
	S: 0		
	S: 1		
	S: 2		
	S: 3 (High)		
START STOP 	Press Start/Stop to save the setting value and continue to the next setting.		
PROG 	E: 0 (Off)	Rinse aid	Rinse aid dosage setting.
	E: 1 (Low dosage)		
	E: 2		
	E: 3		
	E: 4		
	E: 5		
	E: 6 (High dosage)		
START STOP 	Press Start/Stop to save the setting value and continue to the next setting.		
PROG 	T: 0 (Off)	TAB (3-in-1/all-in-one detergent)	<p>This option can be activated when using 3-in-1/all-in-one detergents. The dishwashing programme automatically adapts to provide the best possible dishwashing and drying results every time. If you deactivate this option, the dishwasher will return to ordinary function for all programmes.</p> <p>If this setting is activated there is no need to add rinse aid since this option disables rinse aid dispensing. It also reduces the amount of salt added to the water softener.</p>
	T: 1 (On)		
NOTE!			
In order to achieve good dishwashing results, it is essential to check which type of detergent or all-in-one product best suits your needs! Read the detergent packaging carefully for information on proper use. Always follow the directions for use or information on the detergent packaging!			
START STOP 	Press Start/Stop to save the setting value and continue to the next setting.		

Button press	Options	Settings	Description
PROG 	Ⓜ: 0 (Soft water)	Water hardness	Adjusting the water softener. Read off the appropriate setting from the water hardness table below.
	Ⓜ: 1		
	Ⓜ: 2		
	Ⓜ: 3		
	Ⓜ: 4		
	Ⓜ: 5		
	Ⓜ: 6		
	Ⓜ: 7		
	Ⓜ: 8		
	Ⓜ: 9 (Hard water)		
START/STOP 	Press Start/Stop to exit the settings menu.		

°dH	°fH	Ⓜ
0-5	0-9	Ⓜ: 0
6-8	10-14	Ⓜ: 1
9-11	15-20	Ⓜ: 2
12-14	21-25	Ⓜ: 3
15-19	26-34	Ⓜ: 4
20-24	35-43	Ⓜ: 5
25-29	44-52	Ⓜ: 6
30-39	53-70	Ⓜ: 7
40-49	71-88	Ⓜ: 8
50+	89+	Ⓜ: 9

CARE AND CLEANING

COARSE FILTER

The coarse filter traps larger food particles, which cannot get past the drainage pump. Empty the coarse filter as necessary.

- 1 Lift the coarse filter by the handle.
- 2 Empty the coarse filter. Remember to replace it!

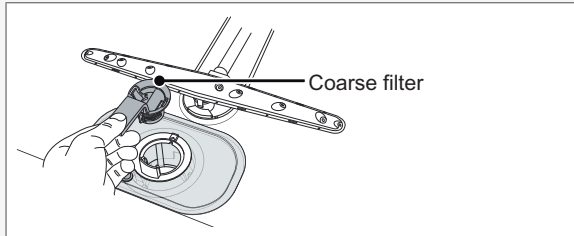

FINE FILTER

Debris that collects on the fine filter is automatically rinsed away during each wash. However, the fine filter and its pipe section should be cleaned a couple of times a year.

- 1 Turn the handle anticlockwise once.

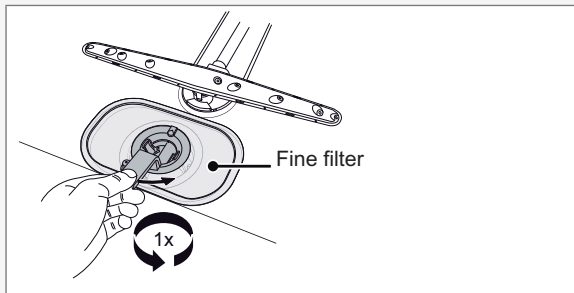

- 2 Lift the pipe section straight up by the handle. Free the coarse filter to clean the pipe section.
- 3 Remove and clean the fine filter.
- 4 Replace in reverse order. Check that the edges seal properly when replacing the fine filter.

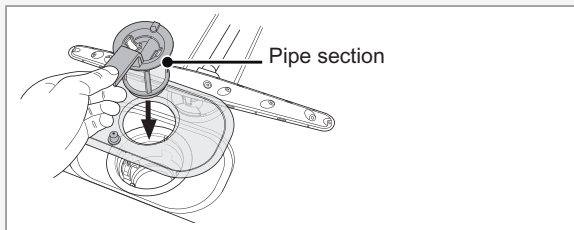

- 5 Lock the filter in place by turning the handle clockwise to the stop position. The handle should point straight out from the dishwasher.

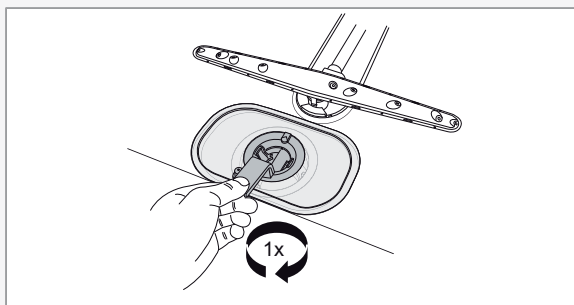

NOTE!

The dishwasher must not be used without the filters in place!

Dishwashing results may be affected if the coarse filter is incorrectly fitted.

DRAINAGE PUMP

The pump can be accessed from inside the dishwasher.

- 1 Cut the power to the dishwasher by pulling out the plug from the wall socket!
- 2 Remove the coarse filter and pipe section.
- 3 Remove the small yellow fitted piece at the left of the bottom drain (see illustration below).

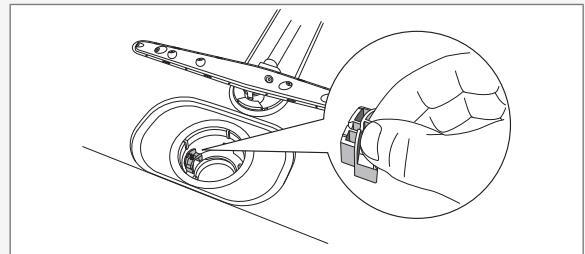

- 4 By inserting your finger into the hole you can turn the pump blade to release anything blocking it.

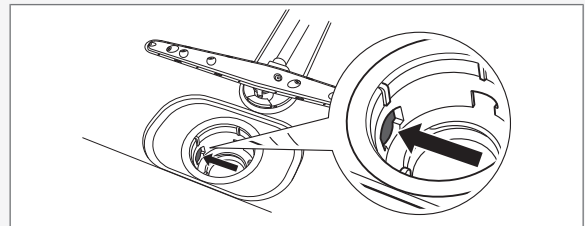

- 5 Reinstall the fitted piece and filters.
- 6 Plug the machine in again.

If the dishwasher still does not start and a whirring sound is heard, the overflow protection has been activated.

- Shut off the water.
- Remove the plug from the wall socket.
- Call the service division.

NOTE!

Do not forget to reinstall the fitted piece.

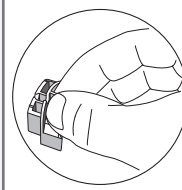

LOWER SPRAY ARM

Holes and bearings can sometimes become blocked.

- 1 Pull the lower spray arm straight up to release it.

- 2 Remove any debris using a needle or the like. The spray arms also have holes underneath.

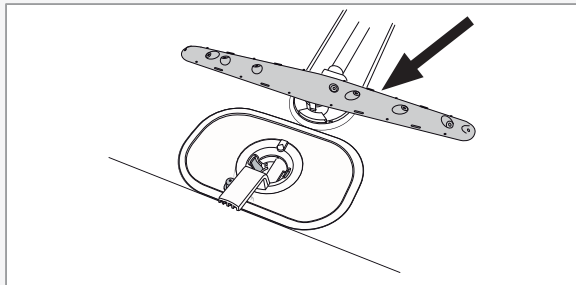

UPPER SPRAY ARM

The upper basket must be removed before the upper spray arm can be released.

- 1 Pull out the upper basket and turn the basket catch on each runner outwards (see illustration). The basket can now be removed.

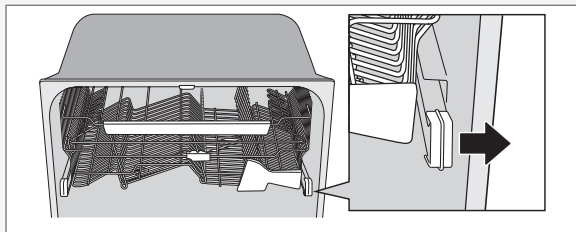

- 2 Loosen the upper spray arm in the same manner as the lower spray arm and clean it.

DOOR

When cleaning the edge around the door, use only a slightly damp cloth (with a little cleaner if necessary).

WARNING!

Do not use a spray bottle or the like around the door lock. This is to ensure that water does not penetrate the door catch and come into contact with the electrical components.

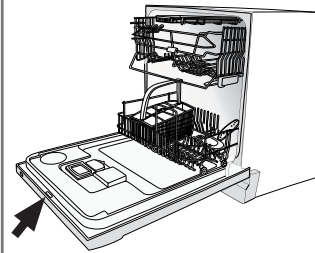

LIMESCALE DEPOSITS

The dishwasher tub is made of stainless steel and is kept clean through normal use. However, if you have hard water, limescale deposits may form in the dishwasher. If this happens, run the Normal wash programme with high temperature and two tablespoons of citric acid in the detergent compartment (with no dishes in the machine).

FRONT PANEL

Keep the touch buttons clean and free from grease. Wipe them clean with a dry or slightly damp cloth. Never use cleaners – they can scratch the surface. Use the On/Left-on mode button to turn off the dishwasher before cleaning the touch buttons to avoid activating any buttons unintentionally.

TROUBLESHOOTING

Display	Type of fault	Action
F: 10	Overfilling	Call the service division.
F: 11	Water outlet fault	See "Water remains in the dishwasher" in the table below.
F: 12	Water inlet fault	Check that the water tap is on.
F:40	Inlet valve leakage	Turn off the water tap and call the service division.

Turn off the machine with the On/Left-on mode button and then turn it on again to clear the error message from the display.

Problem	Possible causes	Action
The dishes are not clean.	The spray arms do not rotate.	Remove the arms and clean them. Check that the dishes are not blocking the spray arms.
	Old detergent. Detergent is a perishable product.	Avoid large packages.
	Incorrect detergent dosage.	Dose according to water hardness. Far too much or far too little detergent results in poorer dishwashing results.
	Dishwashing programme too weak.	Select a higher temperature or a more powerful programme.
	Dishes loaded incorrectly.	Do not cover porcelain with large bowls or the like. Avoid placing very tall glasses in the corners of the baskets.
	Glasses and cups have toppled over during the programme.	Place dishes to sit steady.
	The filter is not correctly fitted.	Screw the filter firmly into place. See the section Care and cleaning.
Spots or films on the dishes.	The water softener is leaking salt.	Check that the salt compartment lid is properly tightened. Otherwise call the service division.
	Incorrect water softener setting.	See the section Settings.
	Incorrect rinse aid dosage setting.	See the sections Before washing for the first time and Settings.
	Salt compartment empty.	Top up with salt. See the section Before washing for the first time.
	Too high temperature and/or too much detergent can cause etching on crystal. Unfortunately, this cannot be repaired, only prevented.	Wash crystal at a low temperature and with a conservative amount of detergent. Contact the detergent manufacturer.
The dishes have a sticky white/blue film.	Rinse aid dosage setting too high.	Reduce the amount. See the sections Before washing for the first time and Settings. If you have very soft water, you may want to dilute the rinse aid 50:50 with water.

Problem	Possible causes	Action
Spots on stainless steel or silver.	Some foodstuffs, such as mustard, mayonnaise, lemon, vinegar, salt and dressings, can mark stainless steel if left for too long.	Rinse off these types of foodstuffs if not starting the dishwasher immediately. Why not use the Rinse & Hold programme.
	All stainless steel can cause spots on silver if they come into contact during dishwashing. Aluminium can also cause spots on dishes.	Silver and stainless steel items should not come into contact during dishwashing.
Spots left after washing.	Lipstick and tea can be difficult to wash off.	Use a detergent with a bleaching agent.
Rattling sound when dishwashing.	The dishes are not correctly placed or the spray arms are not rotating.	Check that the dishes are placed securely. Spin the spray arms to make sure they can rotate.
The dishwasher does not start.	The Start/Stop start button has been pressed for too short a time.	Press and hold Start/Stop until the display shows  (the door open symbol). This indicates that the dishwasher is ready to start.
	The door is not properly closed.	Check.
	A fuse/circuit breaker has been tripped.	Check.
	The plug is not plugged into the wall socket.	Check.
	The water tap is turned off.	Check.
	Overflow/leaks.	Check.
	A whirring sound (the drainage pump) is heard from the dishwasher and does not stop when the power is cut with the On/Left-on mode button.	Turn off the water tap. Pull out the plug and call the service division.
Water remains in the dishwasher.	Blocked drainage hose.	Loosen the drainage hose where it connects to the sink unit's water trap. Check that no debris has fastened. Is the cone-shaped part of the pipe cut to an inner diameter of at least 14 mm?
	Kink in drainage hose.	Check that the hose is free from kinks and sharp bends.
	The filters are blocked.	Clean the coarse and fine filters.
	Debris in the drainage pump.	Clean the drainage pump. See the section Care and cleaning.
Bad odour in dishwasher.	Dirt around the seals and in corners.	Clean with washing-up brush and low foaming cleaner.
	Low temperature programmes have been selected for a prolonged period.	Run a programme with a higher temperature about once a month.
The dishes are not dry enough.	Drying power too low.	Activate the Long dry option.
	The dishwasher is not fully loaded.	Fully load the dishwasher.
	Rinse aid needs topping up or dosage is set too low.	Top up with rinse add or increase the rinse aid dosage. See the sections Before washing for the first time and Settings.
		Open the door a little once the programme has finished.

Problem	Possible causes	Action
Cannot close door.	The baskets are not correctly positioned.	Check that the baskets are correctly positioned horizontally.
		Check that the dishes are not blocking the baskets from sliding properly into place.
The touch buttons do not react when pressed.	You have pressed the touch buttons too soon after opening the door.	Wait a moment then try again.
	Dirt on the touch buttons.	Clean with a dry or slightly damp cloth.
	 If this symbol appears on the display the door is not open enough.	Open the door until the display lights up.
	Child lock (button lock) activated.	See the section Settings.

INFORMATION FOR TEST INSTITUTE

ENERGY LABELLING

European test standard: EN 60436
 Number of standard place settings: 13
 Dishwashing programmes: Eco wash, High temperature
 Connection: Cold water 15 °C
 Test method for noise measurement: IEC 60704-2-3

DOSAGES DURING TESTING

Detergent: In accordance with EN 60436
 Prewash: 7.5 gram
 Main wash: 25 gram
 Rinse aid: In accordance with EN 60436
 Rinse aid dosage: 5

LOADING THE DISHWASHER

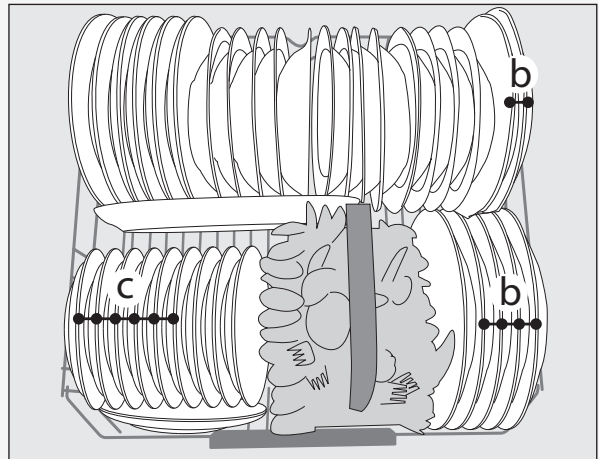
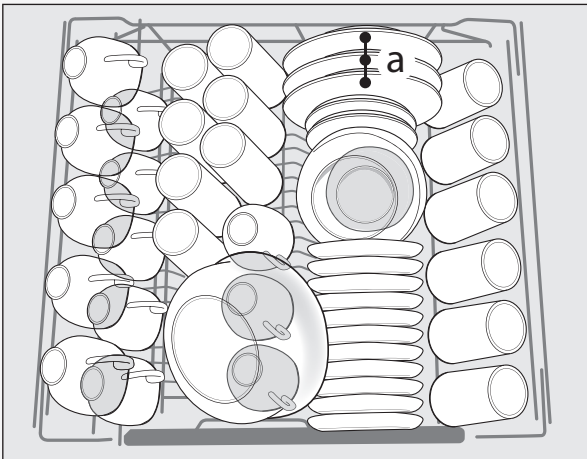

- a egg
- b minced meat
- c spinach

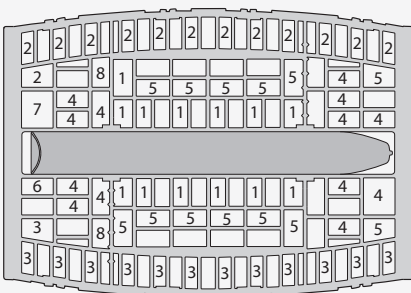

- 1 Teaspoons
- 2 Dessertspoons
- 3 Soupspoons
- 4 Forks
- 5 Knives
- 6 Serving cutlery – fork
- 7 Serving cutlery – gravy ladle
- 8 Serving cutlery – spoons

TECHNICAL INFORMATION

INFORMATION ON ENERGY LABELLING

Information sheet, in compliance with Commission Delegated Regulation (EU) No. 1059/2010

ATAG

Model designation:	VA681 INT
Number of standard place settings:	13 ¹⁾
Energy efficiency class:	A++
Annual energy consumption(AE _C):	261 kWh per year ²⁾
Energy consumption of the standard cleaning cycle(E _d):	0,92 kWh
Power consumption	
Off-mode (P _o):	0.49 W
Left-on mode (P _l):	0.49 W
Annual water consumption (AW _C):	2990 litres per year ³⁾
Drying efficiency class:	A ⁴⁾
Standard programme:	Eco wash, High temperature ⁵⁾
Programme time for the standard cleaning cycle:	215 minutes
Duration of the left-on mode (T _l):	Infinite
Noise emissions:	46 dB(A) re 1 pW
Construction:	Integrated product

¹⁾ In accordance with standard, EN 50242.

²⁾ Based on 280 standard cleaning cycles with a cold water connection and consumption in accordance with energy saving mode. The actual energy consumption depends on how the machine is used.

³⁾ Based on 280 standard cleaning cycles. The actual water consumption depends on how the machine is used.

⁴⁾ On a scale from G (least efficient) to A (most efficient).

⁵⁾ This dishwashing programme is the standard cleaning cycle used to compile the energy labelling information. It is intended for washing normally dirty dishes and is the most effective programme in terms of combined energy and water consumption.

TECHNICAL DATA

Height:	817-872 mm
Width:	596 mm
Depth:	550 mm
Weight:	52 kg ¹⁾
Water pressure:	0.03–1.0 MPa 0.3–10 kp/cm ² 3–100 N/cm ²
Electrical connection:	See type plate.
Rated power:	See type plate.

¹⁾ Weight can vary due to different specifications.

INSTALLATION

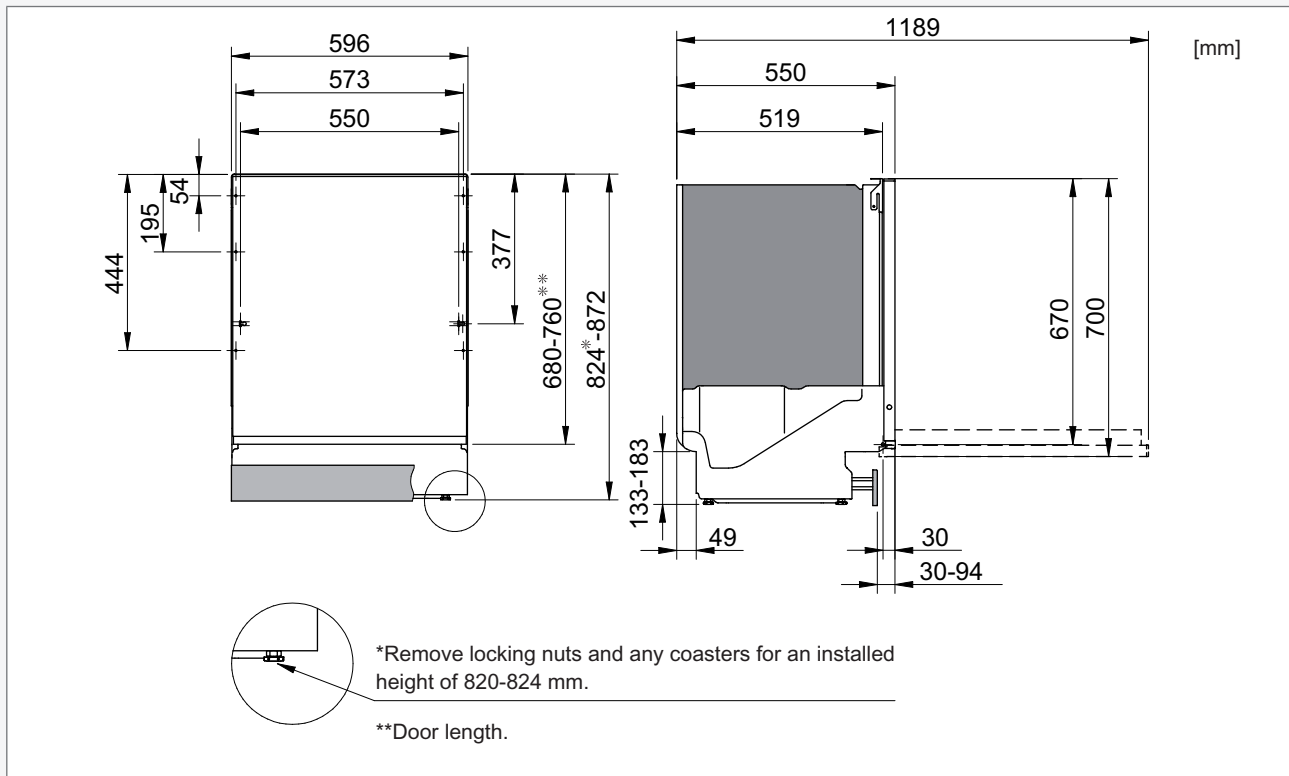

It is important that you read through and follow the instructions and directions below. Conduct installation and connection in accordance with the separate installation instructions.

SAFETY INSTRUCTIONS

- Connections to electricity, water and drainage must be performed by a qualified professional.
- Always follow applicable regulations for water, drainage and electricity.
- An incorrect or flawed installation can result in higher consumption of energy, water and detergent, which can result in increased costs and poor dishwashing results. In order to minimise noise it is important that you follow the instructions.
- Take care during installation! Wear protective gloves! There must always be two people!
- Place a watertight protective tray on the floor beneath the dishwasher to prevent damage from any water leaks.
- Before screwing the dishwasher into place, test the dishwasher by running the Rinse & Hold programme. Check that the dishwasher fills with water and drains. Check also that none of the connections leak.

! WARNING!

Turn off the water supply when installing the dishwasher!

! WARNING!

The plug must be disconnected or power to the socket turned off while the work is carried out!

SETUP

- The recess and connection dimensions are included in the separate installation instructions. Check that all dimensions are correct before starting the installation.
- Make sure the area on which the dishwasher is to be installed is firm. Adjust the adjustable feet so that the dishwasher is level. Tighten the lock nuts.

DRAINAGE CONNECTION

See the separate installation instructions for all necessary information.

This dishwasher is suitable for installing in a raised recess (to attain an ergonomic working height). This means that the dishwasher can be placed so that the drainage hose runs to a lower level than the bottom of the dishwasher, such as by routing it directly to a floor drain. The dishwasher is fitted with an integrated anti-siphon device to prevent the machine from being emptied of water during the wash cycle.

The drainage hose can also be connected to a connection nipple on the sink unit's water trap. The connection nipple must have an internal diameter of at least 14 mm.

The drainage hose may be extended by a maximum of 3 m (the total length of the drainage hose must not exceed 4.5 m). Any joints and connecting pipes must have an internal diameter of at least 14 mm. However, the drainage hose should ideally be replaced with a new hose without joints.

No part of the drainage hose may be more than 950 mm above the bottom of the dishwasher.

SERVICE

Ensure that the drainage hose has no kinks.

CONNECTION TO WATER SUPPLY

Use only the supply hose provided with the dishwasher. Do not re-use old hoses or other spare supply hoses.

The supply pipe must be fitted with a stopcock. The stopcock must be easily accessible, so that the water can be shut off if the dishwasher has to be moved.

Once the installation is complete, the stopcock should be opened to allow the pressure to settle for a while and to check that all connections are tight.

Connect to cold water...

If you use oil or electricity to heat your home.

Connect to hot water (max. 70 °C)...

If you use district heating, solar power or geothermal power to heat your home. Choosing a hot water connection cuts programme times and reduces the dishwasher's electricity consumption.

ELECTRICAL CONNECTION

Information about the electrical connection can be found on the serial number plate. This specification must match the electricity supply.

Dishwashers fitted with a plug must be connected to an earthed socket.

The electric wall socket must be placed outside of the installation area to be easily accessible after installing the dishwasher. Do not use an extension cord!











NOTE!

Repairs and maintenance relating to safety or performance must be carried out by a qualified professional.

Read chapter Troubleshooting before contacting the service department. Note down the details on the rating plate positioned on the right inside the dishwasher. Note down the item number (1) and serial number (2).



PROGRAMME CHART

Program	Options	Prewashes	Main wash (°C)	Number of rinses	Final rinse temperature (°C)	Consumption values ¹⁾						
						Cold water ²⁾			Hot water ³⁾			Water consumption (liter)
						Wash time (approx. hours:minutes)	Energy (approx. kWh)	Wash time (approx. hours:minutes)	Energy (approx. kWh)			
Auto Auto wash	-	1-3	40-50	2-4	65	2:10-2:50	1.1- 1.4	2:00-2:40	0.7- 1.0	13-25		
 Heavy wash	-	2	55	3	65	3:15	1.5	3:00	1.0	19		
 Normal wash	-	2	60	3	65	2:40	1.6	2:25	0.9	19		
 Daily wash	-	1	60	2	65	2:25	1.3	2:10	0.7	13		
 Quick wash	-	0	30	2	-	0:20	0.2	0:20	0.1	10		
 Super quick wash	-	0	30	2	-	0:15	0.2	0:15	0.1	10		
 Delicate wash	-	1	40	2	50	1:40	0.9	1:25	0.2	15		
Eco Eco wash ⁴⁾		0	60	2	60	3:20	0.9	3:05	0.6	11		
 Rinse & Dry		0	-	1	50	0:45	0.5	0:40	0.4	3		
 Rinse & Hold	-	0	-	1	-	0:06	0.01	0:06	0.01	3		

1) Consumption values vary depending on the temperature of the incoming water, room temperature, load size, selected additional functions and more.

2) Connection to cold water, approx. 15 °C.

3) Connection to hot water, approx. 60 °C.

4) This dishwashing programme is the standard cleaning cycle used to compile the energy labelling information. It is intended for washing normally dirty dishes and is the most effective programme in terms of combined energy and water consumption.

YOUR NOTES

Lined area for notes with horizontal lines.

QUICK GUIDE

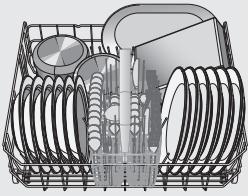

1.

LOAD THE BASKETS (SEE PAGE 5)

Do not rinse dishes under running water before loading them in the dishwasher. Simply scrape off large food particles before loading the dishwasher.

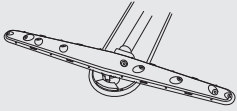

2.

CHECK THAT THE SPRAY ARMS CAN ROTATE FREELY

Check also that the water tap is on.

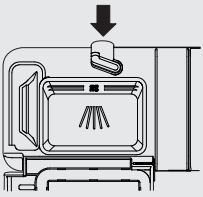

3.

ADD DETERGENT (SEE PAGE 7)

The detergent compartment has one smaller compartment for the prewash and one for the main wash.



4.

PRESS AND HOLD THE ON/LEFT-ON MODE BUTTON UNTIL THE DISPLAY LIGHTS UP

PROG



5.

SELECT A PROGRAMME AND ANY OPTIONS (SEE PAGE 8)

 Daily wash is an effective daily programme for those who are time conscious.

 Normal wash a powerful programme for daily use with maximum rinsing effect. It gives you outstanding results for cleaning and drying.

(Feel free to try the other programmes and any options that suit your needs.)

**START
STOP**



6.

PRESS AND HOLD START/STOP AND CLOSE THE DOOR (SEE PAGE 9)

