

instructions for use
steam oven

ATAG



SQ4211T

SQ4292T

SQ4311T

SQ4392T

Contents

Control panel	4
Oven features	5
Accessories	6
Using this manual	7 - 10
Filling the water tank	11
Explanation of knobs and buttons	12 - 16
Before you begin	17 - 18
Modes and settings	19 - 20
Adjusting the cooking time.	21
Setting the delayed start time	22
Using the steam mode.	23 - 25
Using the hot air + steam mode	26 - 27
Using the reheat mode	28
Using the hot air mode	29 - 30
Using the grill mode.	31 - 32
Using the auto cook mode	33 - 44
Using stage cooking	45 - 46
Add your own programmed dishes	47 - 48
Choose your own programmed dishes	49
Delete your own programmed dishes	50
Using the defrost mode	51 - 52
Using the keeping warm mode	53
Setting the water hardness	54
Descaling	55 - 56
Using the steam clean feature	57
Cleaning and care	58 - 60
Changing the oven lamp	61
Error codes	62
Technical specifications.	63
Disposal of package and appliance	63

Control Panel

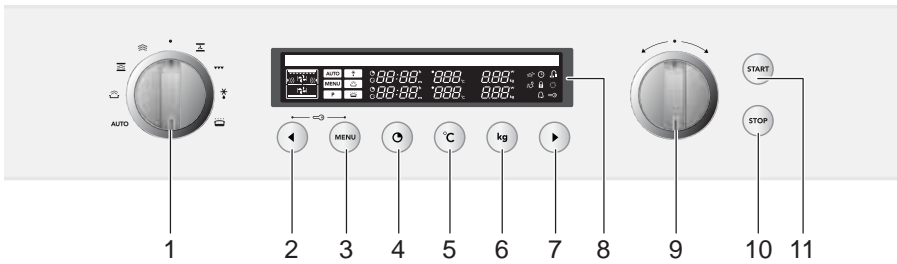

1. MODE KNOB
2. BACK BUTTON
3. MENU BUTTON
4. COOK TIME BUTTON / DELAYED START TIME BUTTON
5. TEMPERATURE BUTTON
6. WEIGHT BUTTON
7. NEXT BUTTON
8. DISPLAY
9. SELECTION KNOB
10. STOP BUTTON
11. START BUTTON

Oven Features

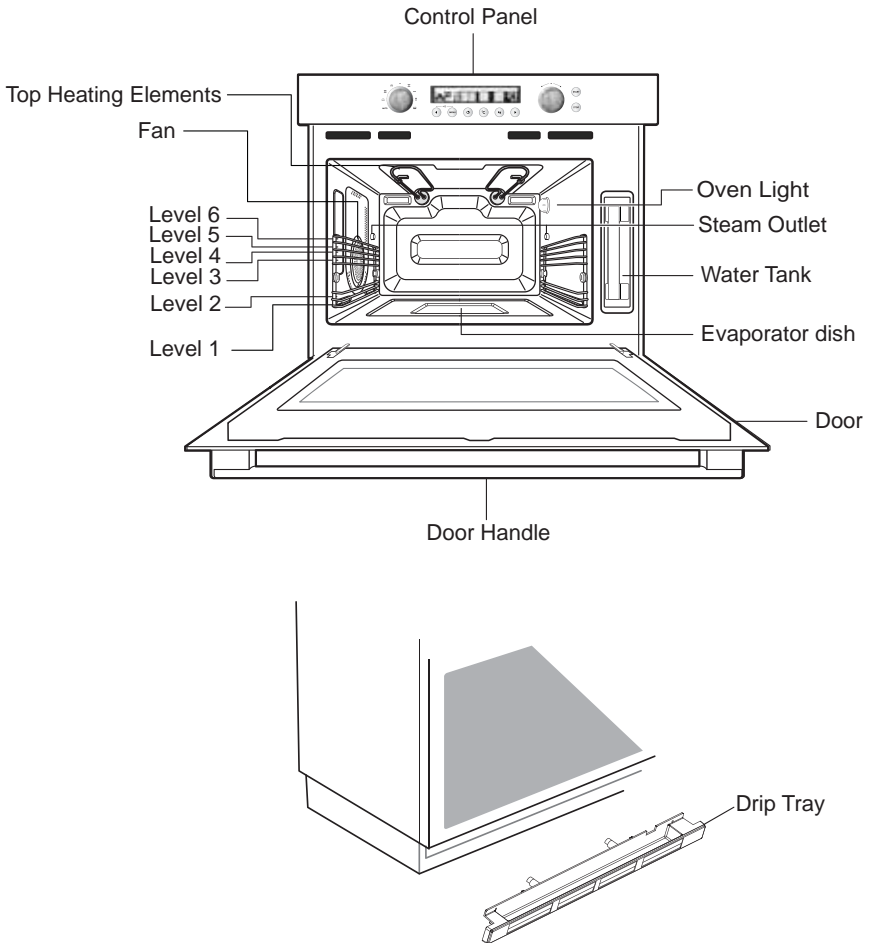

Note

- Shelf levels are numbered from the bottom up.
- The levels 4, 5 and 6 are mainly used for the grill function.
- Levels 1 is mainly used for baking and roasting.
- Please refer to the Cooking Guides provided throughout this booklet to determine the appropriate shelf level for your dishes.

Accessories

The following accessories are provided with your Combi Steam Oven:

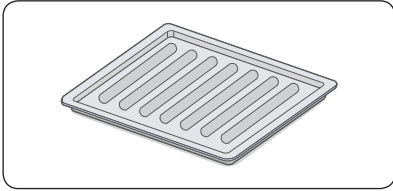

1 Multi pan (for level 1 or 6)

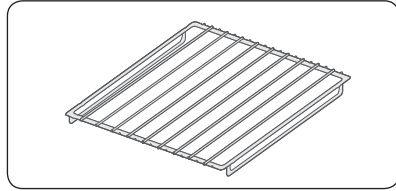

2 Grill insert for multi pan or for unperforated steam dish

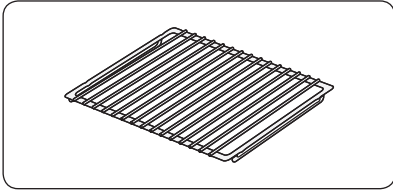

3 Wire rack (for all levels)

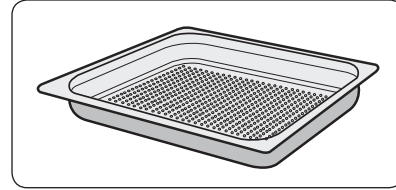

4 Large steam dish, perforated, 40 mm deep, GN 2/3 (useful for steam mode, for level 2, 3, 4 and 5)

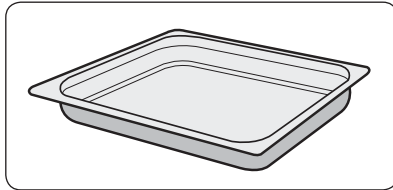

5 Large steam dish, unperforated, 40 mm deep, GN 2/3 (useful during steam mode for collecting condensation, for level 2, 3, 4 and 5)

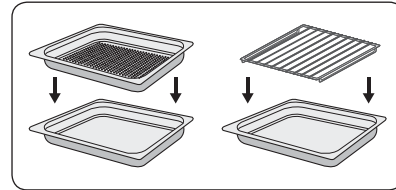

For steaming, you can place the perforated steam dish or the grill insert into the unperforated steam dish.

Accessories can be purchased from www.atag.nl.

Use only the accessories supplied with the product or available from the after-sales service. They are specially designed for your appliance.

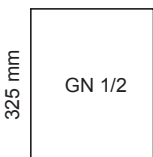

265 mm

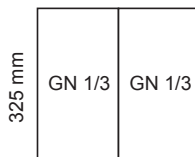

175 mm 175 mm

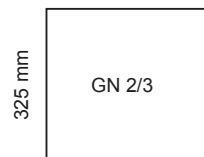

350 mm

Using this Manual

Thank you for purchasing this ATAG Combi Steam Oven.

Your Owner's Manual contains important safety instructions and essential information on using and caring for your new Combi Steam Oven.

Before using your oven, please read all the information in this manual and keep it for future reference.

Before installaton

Environmentally-friendly disposal

Unpack the appliance and dispose of the packaging in an environmentally-responsible manner.



This appliance is labelled in accordance with European Directive 2002/96/EU on Waste Electrical and Electronic Equipment - WEEE.

The directive gives a framework for the collection and recycling of old appliances, which is valid across the EU.

After unpacking

Do not open the cooking compartment door while the appliance is on the floor. The cooking compartment door could touch the floor and be damaged.

Check the appliance for damage after unpacking it. Do not connect the appliance if it has been damaged in transport.

Your appliance was thoroughly factory tested for proper operation. It may therefore contain some remaining water.

Installation and connection

Please observe the special installation instructions.

Electrical connection

If the power cable is damaged, it must be replaced by customer service in order to prevent hazards.

Safety precautions



This appliance is intended only for domestic use. This appliance must only be used for food preparation.

- This appliance is not intended for use by persons (including children) with reduced physical, sensory or mental capabilities, or lack of experience and knowledge, unless they have been given supervision or instruction concerning use of the appliance by a person responsible for their safety.
- Children should be supervised to ensure that they do not play with the appliance.

Hot cooking cavity

There is a risk of burning!



- During use the appliance becomes hot. Care should be taken to avoid touching heating elements.
- Open the cooking compartment door carefully. Hot steam can escape.

WARNING

- Accessible parts may become hot during use. Young children should be kept away.

Risk of fire!

- Never store combustible items in the cooking compartment.

There is a risk of short-circuiting!

- Never trap cables of electrical appliances in the hot cooking compartment door. The cable insulation could melt.

Hot accessories



There is a risk of burning!

- Never take accessories out of the appliance without using oven gloves.

Cleaning



Risk of scalding!

- Do not clean the appliance immediately after switching it off. The water in the evaporator dish is still hot. Wait until the appliance has cooled down.
- A Steam cleaner is not to be used.

Repairs



Danger of electric shock!

- Incorrect repairs are dangerous. Repairs may only be carried out by one of our experienced after-sales engineers. If the appliance is faulty, switch it off using the fuse in the fuse box or disconnect the appliance at the mains connection. Contact the after-sales service.

WARNING: Ensure that the appliance is switched off before replacing the lamp to avoid the possibility of electric shock.

Important information about the use of the appliance

Do not use the cooking compartment door as a shelf.

Do not store any food in the appliance. This can lead to corrosion.

Ovenware

Use only the accessories provided. They are specially designed for your appliance.

Ovenware must be heat and steam resistant. Silicone baking tins are not suitable for combined operation with hot air and steam.

Do not use ovenware that shows signs of rust. Even the smallest spots of rust can lead to corrosion in the cooking compartment.

Care and cleaning

The cooking compartment in your appliance is made of steel covered with enamel. Improper care can lead to corrosion in the cooking compartment. Refer to the care and cleaning instructions in the instruction manual.

Salts are very abrasive. If salt is deposited in the cooking compartment, rust could develop in places.

Acidic sauces, such as ketchup and mustard, or salted foods, e.g. cured roasts, contain chloride and acids. These affect the stainless steel surface. Clean the cooking compartment after each use.

DO NOT use harsh abrasive cleaners or sharp metal scrapers to clean the oven door glass since they can scratch the surface, which may result in shattering of the glass (if provided).

Causes of damage

Very dirty seal

If the seal on the outside of the cooking compartment is very dirty, the cooking compartment door will no longer close properly during operation. The fronts of adjacent units could be damaged. Keep the seal clean.

Cooking compartment door as a seat

Do not stand or sit on the cooking compartment door.

Transport

Do not hold or carry the appliance by the door handle. The door handle cannot hold the weight of the appliance and may break off.

Important information about installing the combi steam oven

- This appliance is NOT intended for use in a commercial environment.
- Please observe the installation instructions provided and note that this appliance should only be installed by a qualified technician.
- The appliance is fitted with a plug and must only be connected to a properly installed earthed socket. The fuse protection must be rated at 16 amps (L or B-type miniature circuit breakers).
- In case a new socket is needed, installation and cable connection must only be done by a qualified electrician. If the plug is no longer accessible following installation, a pole disconnecting device must be present on the installation site with a contact gap of at least 3 mm.
- Adapters, multiway strips and extension cords must not be used. Overloading can result in fire.
- **Plug in**
When the appliance has been connected for the first time, the display is prompting you to select the language and set the clock. Do not forget to reset the clock when you switch to and from summer or winter (see the instructions on page 17).

Filling the Water Tank

When you open the cooking compartment door, you will see the water tank on the right-hand side. Only fill the tank with fresh tap water or with still bottled water. If your water is very hard, we recommend that you use softened water (see also “Water hardness”).

Caution

Do not fill the water tank with distilled water or any other liquids.

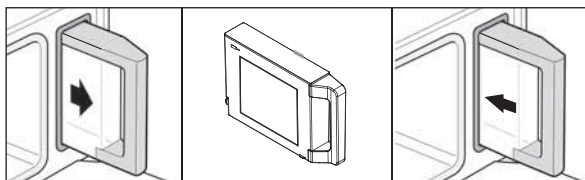

Fill the water tank before each use

Lift the water tank over the interlock and pull the tank out of the appliance. Fill the water tank with cold water up to the “max.” mark. Close the lid until you feel it engage. Slide the water tank back until it engages.

Empty the water tank after each use

Pull the water tank out of the appliance slowly. Pulling it out quickly may cause water to spill. Hold the water tank horizontally, so that no remaining water can drip out of the valve seat.

Empty out the water.

Thoroughly dry the water tank in the appliance and the lid.

“Fill water tank” display

If the water tank is empty, a signal sounds.

A symbol  appears in the display. The operation is interrupted.

1. Open the cooking compartment door carefully. Steam will escape.
2. Take out the water tank, fill to the “max” mark and reinsert.
3. Press the **START** button.

Removing drip tray



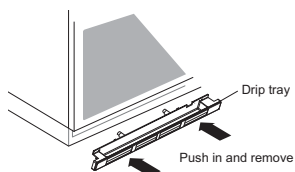

Empty drip tray at regular intervals. Push drip tray in until you hear a click, and remove tray from locked position.







Explanation of knobs and buttons

After you have pressed the **Menu Button**, you can choose several settings by turning the **Selection Knob**. Choose a setting, press the **Next Button** to confirm and again you can choose several settings by turning the **Selection Knob**. In the table below you can see the settings you can choose.

Menu





			
	Time	Hours/Minutes (see page 17)	
	Language	English	Language is adjusted
		Nederlands	
		Deutsch	
		Français	
		Dansk	
	Sound	On	Sound is adjusted
		Off	
	Contrast	1	Contrast is adjusted
		2	
		3	
Cleaning	Steam clean	Steam clean starts	
	Decalcify	Decalcify starts	
Water hardness	Water hardness 1. Very soft 2. soft 3. hard 4. very hard	Water hardness is adjusted	
Dishes	Add (see page 47-48)		
	Delete (see page 50)		
Auto shut off (clock)	Yes	Auto shut off is turned on (see page 17)	
	No	Auto shut off is turned off (see page 17)	

Cook time





			
Cook time is blinking	Set the cooking time	Confirm, the cooking time stops blinking	If the 'Temperature' button is pressed, these functions will start blinking and can be adjusted

Explanation of knobs and buttons (Continued)





Delayed start time

 Press for three seconds			
Delayed start time is blinking	Set the delayed start time	Confirm, the delayed start time stops blinking	If the 'Cook Time' or 'Temperature' button is pressed, those functions will start blinking and can be adjusted (if available)



Temperature

			
Temperature is blinking	Change the temperature	Confirm, the temperature stops blinking	If the 'Cook Time' or 'Delayed start time' button is pressed, those functions will start blinking and can be adjusted (if available)

Weight

			
Weight is blinking	Change the weight	Confirm, the weight stops blinking	If the 'Cook Time', 'Temperature' or 'Delayed start time' button is pressed, those functions will start blinking and can be adjusted (if available)



Childlock

			
Press at the same time	Child lock is set (lock symbol light is on)	Press at the same time again	Child lock is released (lock symbol light is off)







Explanation of knobs and buttons (Continued)

If you have chosen a mode with the **Mode Knob**, you can also choose and change several settings by turning the **Selection Knob**.







Auto Cook Mode

				
AUTO	Auto Cook Menu	Select a category and press 'Next' to confirm	Select a food item and press 'Next' to confirm	See page 33 - 34 for further information







Reheat Mode

					
	Reheat	Press to adjust the cooking time/delayed start time	Set the cooking time/delayed start time	Confirm	Start

Hot Air + Steam Mode







		 			
	Hot air + Steam	Press to adjust the cooking time/delayed start time/temperature	Set the cooking time/delayed start time/temperature	Confirm	Start

Steam Mode







		 			
	Steam	Press to adjust the cooking time/delayed start time/temperature	Set the cooking time/delayed start time/temperature	Confirm	Start

Explanation of knobs and buttons (Continued)







Hot air Mode

					
	Hot air	Press to adjust the cooking time/delayed start time/temperature	Set the cooking time/delayed start time/temperature	Confirm	Start







Grill Mode

					
	Grill	Press to adjust the cooking time/delayed start time	Set the cooking time/delayed start time	Confirm	Start

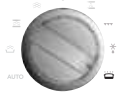
Defrost Mode

					
	Defrost	Press to adjust the cooking time/delayed start time/temperature	Set the cooking time/delayed start time/temperature	Confirm	Start









Keeping Warm Mode

					
	Keeping warm	Press to adjust the cooking time/delayed start time	Set the cooking time/delayed start time	Confirm	Start

Explanation of knobs and buttons (Continued)

If you choose an Auto Menu by turning the **Mode Knob** or if you press the **Menu button**, you will see text in the display. There are also some symbols in the display. In the table below you can see what you can do if you see these symbols.

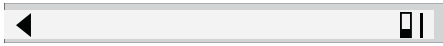
Symbols in the Textdisplay

Symbols in the textdisplay	Buttons/knobs	Explanation
		Turn to choose ('scroll' through the menu)
		Confirm
		Turn to choose ('scroll' through the menu)
		Confirm
		Go back one step
		Start (no more 'scrolling')
		Go back one step

Before you begin

Setting the Language and the Clock

When the power is first supplied to the oven, you must set the language and the time.

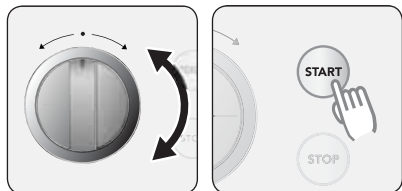

- 1** Turn the **Selection Knob** to set the language. Press the **Start Button** to confirm.

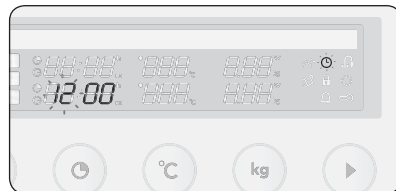

- 2** Now you have to set the right time. The '🕒' and '12' will blink.

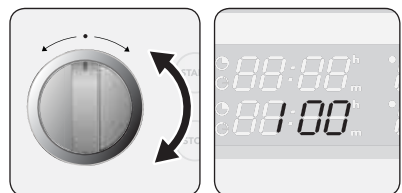

- 3** Example: to set 1:30. Turn the **Selection Knob** to set the hour of the day.

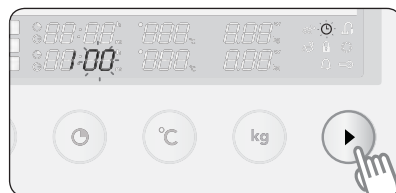

- 4** Press the **Next Button** to confirm. The '🕒' and '00' will blink.

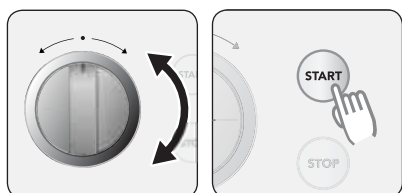

- 5** Turn the **Selection Knob** to set the minute of the time and press the **Start Button** to finish setting the clock. '🕒' will disappear and '30' will stop blinking.



- 6** The display shows the time of day. The appliance is now ready to use. If you want to change the time later on, you can do this by pressing the **Menu Button** and choose 'Time' by turning the **Selection Knob**. Then follow step 2-6 as described on this page.

Automatic shut off (clock)

If the knobs of the oven are not operated for more than 30 minutes, the display will turn off automatically for energy saving reasons. By operating any key, the display is switched on again. If desired, this function can be turned off (see page 12; 'Auto shut off').

Before you begin (Continued)

Notes

- 1) During cooking, **COOK TIME**, **DELAYED START TIME** and **TEMPERATURE** can be changed.
 - ▶ Cooking time: press the **Cook Time Button**, turn the **Selection Knob** and press the **Cook Time Button** again to confirm (see page 21).
 - ▶ Delayed start time: press and hold the **Cook Time Button**, turn the **Selection Knob** and press the **Cook Time Button** again to confirm (see page 22).
 - ▶ Temperature: press the **Temperature Button**, turn the **Selection Knob** and press the **Temperature Button** again to confirm.
- 2) In Steam mode settings, the top and bottom steam heating elements switch off and on throughout cooking to regulate the temperature.
- 3) In Hot air Mode settings, the top and bottom heating elements switch off and on throughout cooking to regulate the temperature.
- 4) Be careful when removing the plate as it is hot. **First leave the door a little open to allow the hot steam to escape.** Pay attention to the steam outlets as well.
- 5) When you have finished cooking/defrosting, pour out the water in the drip tray and empty the tank.
- 6) Dry the cooking cavity with a dry cloth if there is any remaining water.
- 7) The cooling fan always works for 3 minutes after a steaming process. However, this is not a malfunction and you do not need to worry about this.

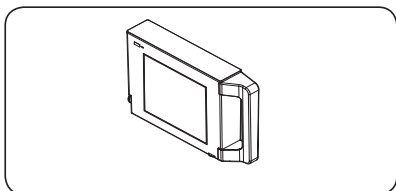

If there is too little water while cooking, you will see the symbol  in the display along with a beep being played. Add water into the tank and press **START** to continue with the steaming.

- You can add water into the tank at any time while cooking.

Important

- ▶ When using the Hot Air + Steam mode, be sure that the baking dishes are suitable for 100-230 °C cooking temperatures.
- ▶ When using the Hot Air mode, be sure the baking dishes are suitable for 40 - 230 °C cooking temperatures.

When the cooking has finished, the oven will beep and 'End' will flash four times. The oven will then beep one time per minute.

Modes and Settings

The following table represents the various oven modes and settings of your oven. Use the cooking guide tables for those modes as guidelines for cooking.



Steam Mode

Food is cooked by steam provided by the steam generator and injected into the cavity by two jet nozzles.

This mode is suitable for steaming food like vegetables, fish, eggs, fruits and rice. When cooking by using this mode, always fill the water tank with fresh water.

Temperature range: 40~100 °C



Hot Air + Steam Mode

Food is cooked by hot air mode and the help of steam. The steam is provided by the steam generator and injected into the cavity by interval.

This mode is suitable for baking pastries, such as puff pastry, brioches, yeast buns, bread rolls, gratins and roasting meat. The superheated steam will provide a nice crisp, shiny surface and fluffy structure. Meat roasts and fish will keep a more juicy texture inside. When cooking with this mode always fill the water tank with fresh water.

Temperature range: 100~230 °C



Reheat Mode

Food is reheated by hot air mode and the help of steam. The steam is provided by the steam generator and injected into the cavity by interval.

This mode is suitable for plated meals. Dishes can be gently reheated without drying out. When reheating with this mode always fill the water tank with fresh water.

Temperature: 120 °C



Hot Air Mode

Food is heated by two heating elements on top of cavity and one bottom heating element, while the fan from the side distributes the hot air evenly.

This setting is suitable for roasting meat, baking pizza and cake.

Temperature range: 40~230 °C



Grill Mode

Food is heated by the top heating elements. We recommend this mode for grilling smaller pieces of meat, such as steaks and sausages, as well for making toasts.

Modes and Settings (Continued)



Defrost Mode

Frozen food is defrosted by steam. The steam is provided by the steam generator and injected into the cavity by interval.

This mode is suitable for frozen meat, poultry, fish and fruit. When defrosting with this mode always fill the water tank with fresh water.

Temperature range: 40~70 °C



Keeping warm

This mode is suitable for keeping warm food.

(Do not keep food warm for longer than 2 hours. Warm food spoils more quickly).

Temperature: 70 °C

AUTO

Auto Cook Programmes

Several pre-programmed auto cook settings can be selected for your convenience. Time and temperature will be set automatically. You simply select the programme, the weight of your dish and start the steam cooking process.

Adjusting the Cooking Time

Example: Adjusting the Cooking Time in Steam Mode

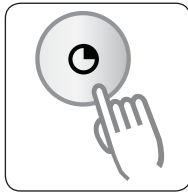

1 Turn the **Mode Knob** to Steam mode position  (default cook time 20 min. temperature 100 °C). Press the **Cook Time Button**.

2 The default cook time and the 'cook time symbol' will blink.

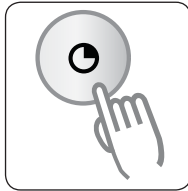
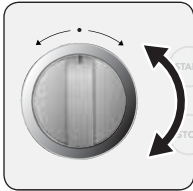



3 Turn the **Selection Knob** to set the desired cooking time and press the **Cook Time Button** to confirm.

4 Press the **Start Button**. The combi steam oven will start.

Setting the Delayed Start Time

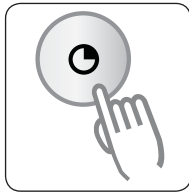
Example: Setting the Delayed Start Time (2 hours) in Steam Mode



1 Turn the **Mode Knob** to Steam mode position  (default cook time 20 min. temperature 100 °C). Press and hold the **Cook Time Button**.

2 The current time and the 'delayed start time symbol' will blink.

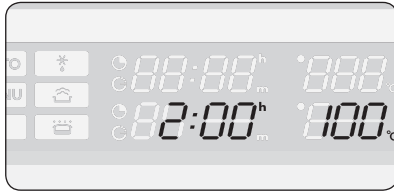
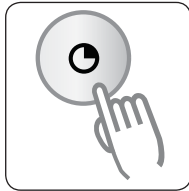
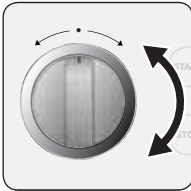

3 Turn the **Selection Knob** to set the desired delayed start time (in this example 2 hours) and press the **Cook Time Button** to confirm.

4 In the display you will see the delayed start time that counts down. You can also read 'Programme wil start in' in the display. The combi steam oven will start automatically after two hours.

Using the Steam Mode

Steam Mode Setting

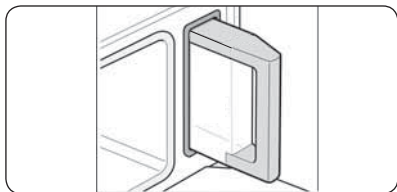

- 1** Fill the water tank up to the maximum line and place it back. Then place your food into the cooking cavity.

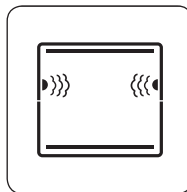

- 2** Turn the **Mode Knob** to Steam mode position  (default cook time 20 min. temperature 100 °C).

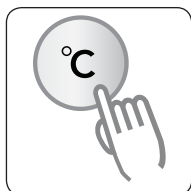
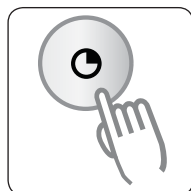

- 3** If desired, adjust the cook time, delayed start time and/or the temperature (if available). See page 21 and 22.



- 4** Press the **Start Button**. The combi steam oven will start.

Using the Steam Mode (Continued)

Steam Mode Setting

Food is cooked by steam provided by the steam generators and injected into the cavity by two jet nozzles.

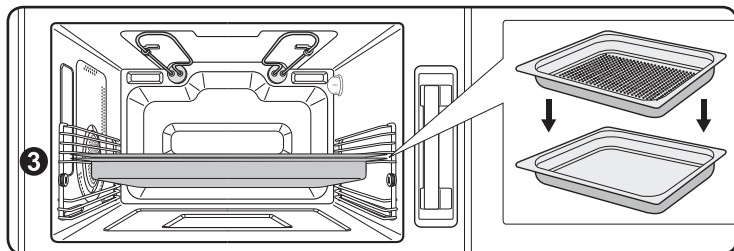

Perforated steam dish, together with solid steam dish, is usually placed on level ③.

Cooking Guide

Use settings and times in this table as guide lines for steaming.

We recommend to always fill the water tank with fresh water to the maximum level.

Food Item	Steam mode (°C)	Accessory (shelf level)	Time (min.)
Broccoli Florets	100 °C	Perforated steam dish together with solid steam dish (3)	12-16
Whole carrots	100 °C	Perforated steam dish together with solid steam dish (3)	25-30
Sliced Vegetables (pepper, courgettes, carrots, onions)	100 °C	Perforated steam dish together with solid steam dish (3)	9-14
Green Beans	100 °C	Perforated steam dish together with solid steam dish (3)	28-33
Asparagus	100 °C	Perforated steam dish together with solid steam dish (3)	15-20
Whole Vegetables (artichokes, whole cauliflower, corn on the cob)	100 °C	Perforated steam dish together with solid steam dish (3)	30-45
Peeled Potatoes (cut into quarters)	100 °C	Perforated steam dish together with solid steam dish (3)	30-35
Fish fillet (2 cm thickness)	80 °C	Perforated steam dish together with solid steam dish (3)	13-18
Prawns (raw/uncooked)	100 °C	Perforated steam dish together with solid steam dish (3)	11-14
Chicken Breast	100 °C	Perforated steam dish together with solid steam dish (3)	23-28

Using the Steam Mode (Continued)

Food Item	Steam mode (°C)	Accessory (shelf level)	Time (min.)
Boiled Eggs (hardboiled)	100 °C	Perforated steam dish together with solid steam dish (3)	15-20
Frozen Yeast Dumplings	100 °C	Perforated steam dish together with solid steam dish (3)	23-28
White Rice (basmati or pandan) (use a pyrex bowl, add rice, add double quantity of water)	100 °C	Wire rack (1)	30-35
Milk Rice (use a flat pyrex dish, add double or four times quantity of milk)	100 °C	Wire rack (1)	40-50
Fruit Compote (use a flat round glass pyrex, add 1 teaspoon sugar and 2 tbsp. water)	100 °C	Solid steam dish (4/5)	25-35
Flan/Crème (6 dessert dishes, each 100 ml, cover dishes with foil)	90 °C	Wire rack (3)	35-40
Egg Custard (use a large flat glass pyrex dish, cover dish with foil)	90 °C	Wire rack (3)	37-42

Two Level Steam Cooking

Use settings and times in this table as guide lines for steam cooking.

We recommend to always fill the water tank with fresh water to the maximum level. If you have different food with a similar preparation time, you can put all the items in the oven at the same time. Otherwise put in first the item with the longest preparation time.

Put one tray on level 1 and the other tray on level 5.

Food Item	Steam mode (°C)	Accessory (shelf level)	Time (min.)
2-level cooking: Dual Meals (fish fillets/ sliced vegetables)	100 °C	Solid steam dish (5) / grill insert with multi pan (1)	15-20
2-level cooking: Dual Meals (chickenbreasts/ whole vegetables)	100 °C	Solid steam dish (5) / grill insert with multi pan (1)	25-30

Using the Hot Air + Steam Mode

Hot Air + Steam Mode Setting

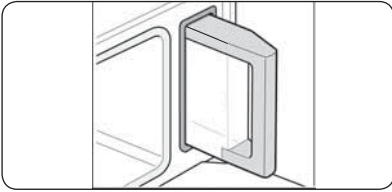

1 Fill the water tank up to the maximum line and place it back. Then place your food into the cooking cavity.

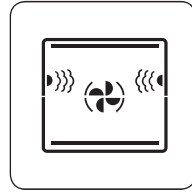

2 Turn the **Mode Knob** to Combi Steam mode position  (default temperature 180 °C).

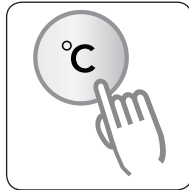
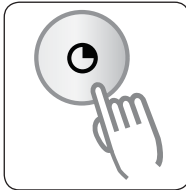

3 If desired, adjust the cook time, delayed start time and/or the temperature (if available). See page 21 and 22.

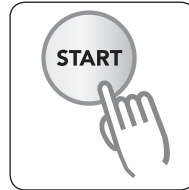

4 Press the **Start Button**. The combi steam oven will start.

Skip Preheating

If you start cooking in the Hot Air + Steam Mode, you will see 'Preheating' in the display. You can skip the preheating by pressing the **Next Button** and then turn the **Selection Knob** to choose 'No'. Press the **Next Button** again to confirm. The combi steam oven will now skip the preheating ('preheating' will disappear in the display).

Using the Hot Air + Steam Mode (Continued)

Hot Air + Steam Mode Setting

Food is cooked by hot air mode and the help of steam. The steam is provided by the steam generators and injected into the cavity by interval.

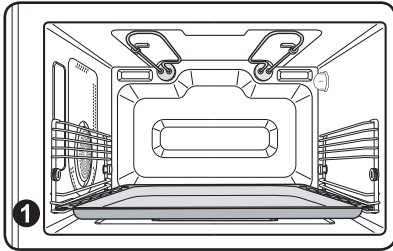

Place the multi pan on level ①.

Cooking Guide

Use settings and times in this table as guide lines for baking and roasting. We recommend to always fill the water tank with fresh water to the maximum level.

Food Item	Combi steam mode (°C)	Accessory (shelf level)	Time (min.)
Puff Pastry Stripes (add grated cheese)	200 °C	Multi pan (1)	15-20
Homemade Bread	180 °C (preheating)	Wire rack (1)	30-35
Vegetable Gratin / Potato Gratin	170-180 °C	Wire rack (1)	35-50
Pork Roast (well done) (1.0 kg)	1. stage: 200 °C hot air mode 2. stage: 170 °C combi steam mode	Grill insert with multi pan (1)	1. stage: 25-35 2. stage: 25-35
Oven Fish	200 °C	Solid steam dish (4/5)	18-22
Croissants (all ready made crois- sant dough)	180 °C	Multi pan (1)	17-23

Using the Reheat Mode

Reheat Mode Setting

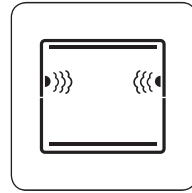
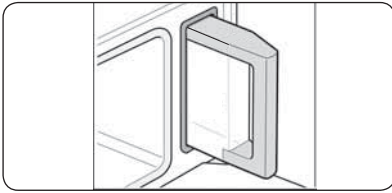

1 Fill the water tank up to the maximum line and place it back. Then place your food into the cooking cavity.

2 Turn the **Mode Knob** to Reheat position  (default: 20 min.).

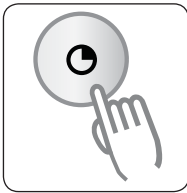

3 If desired, adjust the cook time and/ or the delayed start time (if available). See page 21 and 22.

4 Press the **Start Button**. The combi steam oven will start.

Reheat Cooking

Use settings and times in this table as guide lines for reheating.

We recommend to always fill the water tank with fresh water to the maximum level.

Food Item	Mode	Accessory (shelf level)	Time (min.)
Plated Meal (250-500 g)	Reheat	Wire rack (3)	13-19
2-level reheating: Plated Meals (two plated meals, each 250-500 g)	Reheat	Wire rack (4) / grill insert with multi pan (1)	17-23

Using the Hot Air Mode

Hot Air Mode Setting

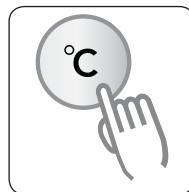
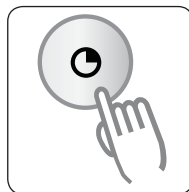
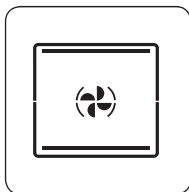

1 Turn the **Mode Knob** to Hot Air position **2** (default temperature 180 °C).

2 If desired, adjust the cook time, delayed start time and/or the temperature (if available). See page 21 and 22.

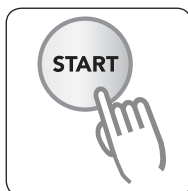

3 Press the **Start Button**. The combi steam oven will start.

Skip Preheating

If you start cooking in the Hot Air Mode, you will see 'Preheating' in the display. You can skip the preheating by pressing the **Next Button** and then turn the **Selection Knob** to choose 'No'. Press the **Next Button** again to confirm. The combi steam oven will now skip the preheating ('preheating' will disappear in the display).

Using the Hot Air Mode (Continued)

Hot Air Mode Setting

Food is heated by two heating elements on top of the cavity and one bottom heating element, while the fan on the side distributes the hot air evenly.

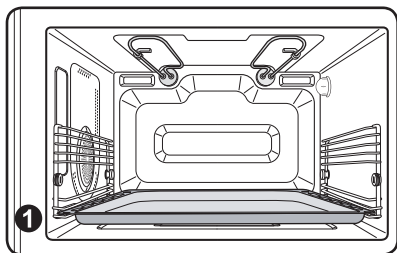

Place the multi pan or wire rack on level ①.

Cooking Guide

Use settings and times in this table as guide lines for baking and roasting.

Food Item	Hot Air mode (°C)	Accessory (shelf level)	Time (min.)
Frozen Pizza (350 g)	220 °C	Multi pan (1)	14-15
Frozen French Fries (450 g)	200 °C	Multi pan (1)	21-26
Frozen Bread Roll (250 g)	180 °C (preheating)	Wire rack (1)	8-12
Frozen Apple Pie	180 °C	Multi pan (1)	30-40
Homemade Pizza (1300 g)	220 °C	Multi pan (1)	20-25
Sponge Cake (500 g)	160 °C (preheating)	Wire rack (1)	30-35
Cake (700 g)	150 °C (preheating)	Wire rack (1)	50-60
Muffins (300 g)	170 °C (preheating)	Wire rack (1)	17-20
Brownies	150 °C	Wire rack (1)	35-45

Using the Grill Mode

Grill Mode Setting

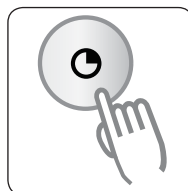
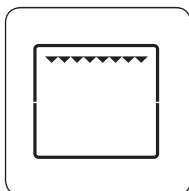

1 Turn the **Mode Knob** to Grill mode position  (default cook time 5 min.).

2 If desired, adjust the cook time and/or the delayed start time (if available). See page 21 and 22.

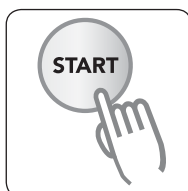

3 Press the **Start Button**. The combi steam oven will start.

Important

- 1) Always use oven gloves when touching the recipients in the oven, as they will be very hot.
- 2) Check that the heating elements are in the horizontal position.

Using the Grill Mode (Continued)

Grill Setting

Food is heated by the top heating elements (horizontal position).

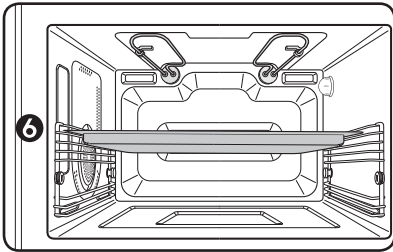

For grilling, the grill insert with multi pan is placed on level **6**. Use the solid steam dish on level **5**.

Cooking Guide

Use settings and times in this table as guide lines for grilling.

Food Item	Mode	Accessory (shelf level)	Time (min.)
Toast (4 slices)	Grill	Grill insert with multipan (6)	1 st side: 4-6 2 nd side: 2-3
Cheese Toast (4 pcs, put some cheese on top at 2 nd side)	Grill	Multi pan (6)	1 st side: 4-6 2 nd side: 3-5
Beef Steaks (500 g)	Grill (preheating 10 minutes)	Grill insert with multi pan (6)	1 st side: 6-9 2 nd side: 4-7
Lamb Chops (400 g)	Grill (preheating 10 minutes)	Grill insert with multi pan (6)	1 st side: 8-10 2 nd side: 6-8
Fresh Vegetables (250 g)	Grill	Solid steam dish (5)	13-17

Using the Auto Cook Mode

In the Auto Cook mode you can choose several dishes. These are divided into 14 categories. In the list below you can see the various categories. The Auto Cook features include/provide pre-programmed cooking times. You do not need to set either the cooking times or the temperature.

You can also choose 'Stage cook' and 'User dishes' when you are in the Auto Cook mode. See page 45 for 'Stage cooking' and page 47 for 'User dishes'.

Categories:

1. Vegetables
2. Side Dishes
3. Meat
4. Poultry
5. Fish
6. Bakery
7. Dishes
8. Desserts
9. Defrost
10. Special
11. Egg Dishes
12. Convenience
13. User Dishes
14. Stage Cook

Using the Auto Cook Mode

The Auto Cook features include/provide pre-programmed cooking times. You do not need to set either the cooking times or the temperature.



- 1 Turn the **Mode Knob** to "AUTO" position.

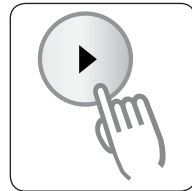
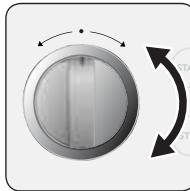

- 2 Turn the **Selection Knob** to choose an auto cook category (see the tables on page 35-44). Press the **Next Button** to confirm the setting.

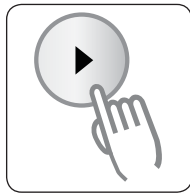
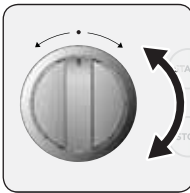

- 3 Turn the **Selection Knob** to choose a food item. Press the **Next Button** to confirm the setting (or the **Start Button** to start the auto cook program).

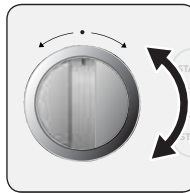

- 4 Turn the **Selection Knob** to choose a sub item (if available). Press the **Start Button** to confirm the setting and to start the auto cook program.

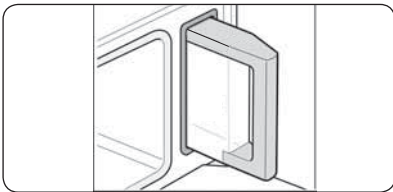

- 5 Fill the water tank up to the maximum line if you see the symbol  in the display and place it back. Place your food into the cooking cavity.

Using the Auto Cook Mode (Continued)

The following tables present the various Auto Programmes for the 12 different Categories of Cooking. It contains its quantities, standing times after cooking and appropriate recommendations. Before using auto cook programmes fill water tank with fresh water up to maximum level. Always use oven gloves while taking out food.

Category: Vegetables

Food Item	Sub-item	Weight (kg)	Accessory (Shelf level)
Cauliflower	Florets	0.2-0.6	Perforated steam dish with solid steam dish (3)
	Put cauliflower florets on the steam dish.		
	Whole	0.2-0.6	Solid steam dish (3)
	Put whole cauliflower on the solid steam dish.		
Broccoli	Florets	0.2-0.6	Perforated steam dish with solid steam dish (3)
	Put broccoli florets on the steam dish.		
	Whole	0.2-0.6	Solid steam dish (3)
	Put whole broccoli on the solid steam dish.		
Carrots	Slices	0.2-0.6	Perforated steam dish with solid steam dish (3)
	Put sliced carrots on the steam dish.		
	Whole	0.2-0.6	Perforated steam dish with solid steam dish (3)
	Put whole carrots on the steam dish.		
Asparagus	Green	0.3-0.6	Perforated steam dish with solid steam dish (3)
	Put green asparagus (\pm 1.5 cm thickness) or asparagus tips on the steam dish.		
	White	0.4-0.8	Perforated steam dish with solid steam dish (3)
	Put white asparagus (\pm 2 cm thickness) on the steam dish.		
Green Beans		0.2-0.6	Perforated steam dish with solid steam dish (3)
	Put green beans on the steam dish.		
Snow peas		0.2-0.4	Perforated steam dish with solid steam dish (3)
	Put snow peas on the steam dish.		
Chicory	Whole	0.2-0.6	Perforated steam dish with solid steam dish (3)
	Put chicory (each 80g) on the steam dish. Cut bigger ones in halves.		
Brussels Sprouts		0.2-0.6	Perforated steam dish with solid steam dish (3)
	Put sprouts on the steam dish.		
Mixed Vegetables	Roasted	0.2-0.5	Multi pan (6)
	Slice vegetables, such as courgettes, pepper, egg plants and onions. Add cherry tomatoes and mushrooms. Sprinkle with a mixture of olive oil, herbs, salt and pepper. Put vegetables on the multi pan.		

Using the Auto Cook Mode (Continued)

Category: Side Dishes

Food Item	Sub-item	Weight (kg)	Accessory (Shelf level)
Potato, steamed	Whole	0.2-0.8	Perforated steam dish with solid steam dish (3)
	Peel potatoes (each 100g) and put on the steam dish.		
	Half	0.2-0.8	Perforated steam dish with solid steam dish (3)
	Peel potatoes and cut into halves(50g) Put on steam dish.		
	Baby potatoes	0.2-0.8	Perforated steam dish with solid steam dish (3)
	Put baby potatoes on the steam dish.		
Potato, roasted	Whole	0.4-0.8	Multi pan (1)
	Use middle sized to large potatoes (each 200g). Wash and clean potatoes. Brush skin with a mixture of olive oil, salt pepper and herbs. Put potatoes side by side on multi pan. Turn over, as soon as the beep sounds. Push start button to continue process.		
	Wedges	0.4-0.6	Multi pan (1)
	Use middle sized to large potatoes (each 200g). Wash and clean potatoes. And cut into wedges. Sprinkle with a mixture of olive oil, salt pepper and herbs. Put potatoes side by side on multi pan.		
Rice	White Rice	0.2-0.4	Wire rack (1)
	Distribute white rice (basmati or pandan) evenly in a flat glass pyrex dish. Add for each 100g of rice, 200ml cold water. Put dish on the wire rack. Stir after steaming.		
	Brown Rice	0.2-0.4	Wire rack (1)
	Distribute brown rice (pre-steamed) evenly in a flat glass pyrex dish. Add for each 100g of rice, 175 ml cold water. Put dish on the wire rack. Stir after steaming.		
	Risotto	0.2-0.4	Wire rack (1)
	Distribute risotto rice evenly in a flat glass pyrex dish. Add for each 100g of risotto, 220 ml hot stock. Put dish on the wire rack. Stir, as soon as the oven beeps. Press start to continue cooking process. Stir after steaming.		

Using the Auto Cook Mode (Continued)

Category: Meat

Food Item	Sub-item	Weight (kg)	Accessory (Shelf level)
Roast Beef	Rare-medium	1.1-1.3	Grill insert + Multi pan (1)
	Brush the beef with oil and spices (pepper only, salt should be added after roasting). Put it on the grill insert with multi pan. Turn over, as soon as the oven beeps. Press start to continue cooking process. After roasting and during standing time it should be wrapped in aluminium foil and leave to stand for 15 minutes.		
	Medium-welldone	1.1-1.3	Grill insert + Multi pan (1)
	Same as above		
	Slowly cooked	1.1-1.3	Grill insert + Multi pan (1)
	Brush the beef with oil and spices. Put it on the grill insert with multi pan. If you like more browning, seal the roast beef shortly in a pan over high heat before roasting in the oven. Result will be rare-medium.		
Roast Pork		0.8-1.0	Grill insert + Multi pan (1)
	Put pork, brushed with oil and spices, with the fat-side down on the grill insert with multi pan. Turn over, as soon as the beep sounds. Push start button to continue process. After roasting and during standing time it should be wrapped in aluminium foil and leave to stand for 15 minutes.		
Ham (boneless)		0.6-0.8	Grill insert + Multi pan (1)
	Put been ham, brushed with oil and spices, with the fat-side down on the grill insert with multi pan. Turn over, as soon as the beep sounds. Push start button to continue process. After roasting and during standing time it should be wrapped in aluminium foil and leave to stand for 15 minutes.		
Leg of Lamb		1.3-1.6	Wire rack (2) + Multi pan (1)
	Put leg of lamb, brushed with oil and spices, with the fat-side down on the wire rack with multi pan. Turn over, as soon as the beep sounds. Push start button to continue process. After roasting and during standing time it should be wrapped in aluminium foil and leave to stand for 15 minutes. Result will be medium-welldone.		
Beef Steak	Thin	0.3-0.6	Grill insert + Solid steam dish (5)
	After preheat, put beef steaks side by side in the middle of grill insert with solid steam dish. (If you like more browning, use shelf level 6). Turn over as soon as the oven beeps. Push start button to continue process.		
	Thick	0.6-0.8	Grill insert + Solid steam dish (5)
	Same as above		
Lamb Chops		0.3-0.6	Grill insert + Solid steam dish (4)
	After preheat, put lamb chops side by side in the middle of grill insert with solid steam dish. (If you like more browning, use shelf level 5). Turn over as soon as the oven beeps. Push start button to continue process.		

Using the Auto Cook Mode (Continued)

Food Item	Sub-item	Weight (kg)	Accessory (Shelf level)
Sausages		0.3-0.6	Grill insert + Solid steam dish (4)
	Put sausages side by side on grill insert + solid steam dish. Turn over, as soon as the oven beeps. Push start button to continue process. (If you like more browning, use shelf level 5).		
Hamburgers		0.5-1.0	Grill insert + Solid steam dish (4)
	Put raw hamburger side by side on the grill insert + solid steam dish. Turn over, as soon as the oven beeps. Push start button to continue process. (If you like more browning, use shelf level 6).		
Smoked Sausage	Steamed	0.2-0.4	Perforated steam dish with solid steam dish (3)
	Put smoked sausages (out of its package) on the steam dish.		

Category: Poultry

Food item	Sub item	Weight (kg)	Accessory (Shelf level)
Chicken	Drumsticks	0.5-0.7	Grill insert + Multi pan (6)
	Brush chilled drumsticks with oil and spices. Put skin-side down on grill insert with multi pan. Turn over, as soon as the oven beeps. Push start button to continue process.		
	Chicken Legs	0.4-0.6 0.7-0.9	Grill insert + Solid steam dish (3)
	Brush chilled chicken legs with oil and spices. Put skin-side down on wire rack with multi pan. Turn over, as soon as the oven beeps. Push start button to continue process.		
	Whole chicken	1.2-1.3 1.4-1.5	Grill insert + Multi pan (1)
	Brush chilled chicken with oil and spices. Put breast-side-down, in the middle of grill insert with multi pan. Turn over, as soon as the oven beeps. Push start button to continue process.		
	Breasts, steamed	0.2-1.0	Perforated steam dish with solid steam dish (3)
	Put chicken breasts side by side on the steam dish.		
Turkey Legs		0.8-0.9	Grill insert + Multi pan (1)
	Brush turkey legs with oil and spices. Put skin-side down, in the middle of grill insert with multi pan. Turn over, as soon as the oven beeps. Push start button to continue process.		
Duck Breasts		0.3-0.5	Grill insert + Solid steam dish (5)
	Brush duck breast with oil and spices. Put skin-side down, in the middle of grill insert + solid steam dish. Turn over, as soon as the oven beeps. Push start button to continue process. Result will be medium.		

Using the Auto Cook Mode (Continued)

Food item	Sub item	Weight (kg)	Accessory (Shelf level)
Chicken Spits		0.3-0.5	Grill insert + Multi pan (6)
	Brush chicken spits with oil and spices (max. size of chicken cubes 3 x 3 cm). Put in the middle of grill insert with multi pan. Turn over, as soon as the oven beeps. Push start button to continue process.		

Category: Fish

Food item	Sub item	Weight (kg)	Accessory (Shelf level)
Fish fillet, 2 cm	Steamed	0.2-1.0	Perforated steam dish with solid steam dish (3)
	Put fish fillets (\pm 2 cm thickness), such as rose fish, pollock and sea-wolf fish side by side on the steam dish.		
	Grilled	0.3-0.6	Multi pan (6)
	Marinate Fish fillets (\pm 2 cm thickness), such as pollock, sea-wolf fish, cod fish. Put side by side on the multi pan. Turn over, as soon as the oven beeps. Push start button to continue process		
Fish steak, 3 cm	Steamed	0.2-1.0	Perforated steam dish with solid steam dish (3)
	Put fish fillets (\pm 3cm thickness), such as tuna, salmon, cod fish side by side on the steam dish.		
	Grilled	0.3-0.6	Multi pan (6)
	Marinate Fish steaks(\pm 3 cm thickness) such as salmon steaks or tuna steaks. Put side by side on the the multi pan. Turn over, as soon as the oven beeps. Push start button to continue process.		
Fish slice, 4cm	Steamed	0.2-1.0	Perforated steam dish with solid steam dish (3)
	Put fish slice (\pm 4 cm thickness), such as salmon slices, monks fish side by side on the steam dish.		
Whole Fish	Grilled	0.4-0.8	Solid steam dish (5)
	Brush skin of whole fish with oil and add herbs and spices. (e.g. trout, gillthead, pike-perch) Put fish side by side, head to tail, widthways on the solid steam dish, shelf level 3. Turn over, as soon as the beep sounds. Push start button to continue process.		
Prawns	Steamed	0.2-0.5	Perforated steam dish with solid steam dish (3)
	Put prawns (raw/uncooked-peeled or unpeeled) on the steam dish.		
	Grilled	0.2-0.5	Grill insert + Multi pan (6)
Put prawns (raw/uncooked-peeled or unpeeled), in the middle of grill insert with multi pan.			
Mussels	Steamed	1.0-1.4	Perforated steam dish with solid steam dish (3)
	Put onions and herbs and spices on steam dish and distribute mussels on it.		

Using the Auto Cook Mode (Continued)

Category: Bakery

Food item	Sub item	Weight (kg)	Accessory (Shelf level)
Bread	White bread	0.7-0.8	Wire rack (1)
	For bread baking use 30 cm loaf tin. Prepare dough according to food manufacturers instructions. Then, put dough into a black metal rectangular loaf tin (length 30 cm). After preheat, put dish widthways to the door on wire rack.		
	Rising yeast dough	0.3-0.6	Wire rack (1)
	Prepare yeast dough for pizza, cake or bread. Put into a large round heat-resistant dish. Do not cover. Put dish on wire rack.		
	Croissants	0.2-0.4	Multipan (1)
Use multi pan with baking paper. Put croissants on baking paper.			
Cake/Pastries	Dutch Loaf Cake	0.7-0.8	Wire rack (1)
	Put fresh batter into suitable sized rectangular metal baking dish (30cm loaf tin) After preheat, put dish lengthways to the door. Put dish on the wire rack.		
	Dutch Butter pie	0.5-0.7	Wire rack (1)
	Put fresh dough into suitable sized round metal baking tin (24cm diameter). After preheat put dish on the wire rack.		
	Sponge Cake	0.3-0.6	Wire rack (1)
	Put 300g batter into 18 cm, 400g~500g into 24 cm and 600g into 26 cm diameter round black metal baking dish. After preheat, set dish in the middle of wire rack.		
	Apple Pie	1.2-1.4	Wire rack (1)
Prepare apple pie in a round black metal dish with a diameter of 20 cm for 1300g, 24 cm for 1400g. After preheat, put dish on the wire rack.			
Cake/Pastries	Muffins	0.5-0.7	Multi pan (1) or Wire rack (1)
	Put muffin batter into paper muffin cups. After preheat, set paper cups in the middle of multi pan, shelf level 1. Or use suitable muffin tin for 12 muffins, and then use wire rack.		
	Brownies	0.5-0.7	Wire rack (1)
	Put batter into rectangular oven/brownie dish. Set dish in the middle of wire rack.		
	Base for fruit pie	0.3-0.5	Wire rack (1)
	After preheat, put fresh batter into metal flan base dish on the wire rack.		
	Apple puff pastry	0.3-0.5	Multi pan (1)
Use multi pan with baking paper. Put puff pastry filled with apple (each 75g) on baking paper. For nice browning, brush with beaten egg.			

Using the Auto Cook Mode (Continued)

Category: Dishes

Food item	Sub item	Weight (kg)	Accessory (Shelf level)
Gratin	Potato Gratin	0.7-1.0	Wire rack (1)
	Use glass or ceramic oven dish. Put oven dish on the wire rack.		
	Vegetable Gratin	0.4-0.8	Wire rack (1)
	Use glass or ceramic oven dish. Put oven dish on the wire rack.		
Lasagne		0.8-1.1	Wire rack (1)
	Use rectangular/square oven dish. Put oven dish on the wire rack.		
Quiche		0.7-0.9	Wire rack (1)
	Use glass or ceramic quiche dish (22-24 cm diameter). After preheat, put dish on the wire rack.		
Homemade Pizza		0.6-1.0	Multi pan (1)
	Prepare 300-350g pizza dough and roll out. Put on baking paper on multi pan.		
Puff Pastry, filled	Minced Meat	0.2-0.6	Multi pan (1)
	Use multi pan with baking paper. Put puff pastry filled with minced meat (each max. 100g) on baking paper. For nice browning, brush with beaten egg.		
	Fish	0.2-0.6	Multi pan (1)
	Use multi pan with baking paper. Put puff pastry filled with fish (each max. 100g) on baking paper. For nice browning, brush with beaten egg.		

Category: Bakery

Food item	Sub item	Weight (kg)	Accessory (Shelf level)
Flan	Steamed	0.4-0.6	Wire rack (3)
	Put flan mixture in 6 small flan dishes (100ml in each). Cover with cling film. Put dishes on wire rack.		
Fruit	Gentle steamed	0.2-0.5	Wire rack (3)
	Put slices of apples, pears or apricots in a flat glass pyrex dish. Add 1 teaspoon sugar and 2 tablespoons water.		
	Soft steamed	0.2-0.5	Wire rack (3)
	Same as above		
Melting chocolate	Dark	0.1-0.3	Wire rack (1)
	Break chocolate (pure or baking chocolate) into pieces, put in a small glass pyrex dish and cover with plastic foil or lid. Put dish on the wire rack. Keep covered during programme. After taking out stir well. (For white or milk chocolate decrease 5 min.)		

Using the Auto Cook Mode (Continued)

Food item	Sub item	Weight (kg)	Accessory (Shelf level)
Steeping dried fruit		0.1-0.5	Perforated steam dish with solid steam dish (3)
	Put dried fruit (apricots, plums, pears, apple) on steam dish.		
Milk rice pudding		0.2-0.4	Wire rack (1)
	Distribute dessert rice evenly in a flat glass pyrex dish. Add for each 100g of rice, 200 ml cold milk. Put dish on the wire rack. Stir after steaming.		

Category: Defrost

Food item	Sub item	Weight (kg)	Accessory (Shelf level)
Frozen meat		0.2-0.5 0.8-1.5	Grill insert + Multi pan (1)
	This programme is suitable for beef, lamb, pork, steaks, chops, minced meat. Shield ends with aluminium foil. Put the meat on the grill insert with multi pan. (cover minced meat with cling film while defrosting). Put meat on the grill insert with multi pan		
Frozen poultry		0.3-0.6 0.9-1.3	Grill insert + Multi pan (1)
	This programme is suitable for whole poultry as well as for poultry portions. Shield ends with aluminium foil. Put poultry on the grill insert with multi pan		
Frozen fish	Fillets	0.3-0.8	Perforated steam dish with solid steam dish (3)
	This programme is suitable for whole fishes as well as for fish fillets. Shield thin ends with aluminium foil. Put fish on the steam dish.		
Frozen bread	Slices	0.1-0.3	Multi pan (1)
	0.1-0.3 is suitable for slices of bread (spread them all out). Arrange bread on a piece of kitchen paper and put bread on the multi pan.		
	Rolls	0.4-0.6	Multi pan (1)
0.4-0.6 is suitable for all kinds of bread, whole, as well as for bread rolls and baguettes. Arrange bread on a piece of kitchen paper and put bread on the multi pan.			
Frozen fruit	berries	0.2-0.6	Perforated steam dish with solid steam dish (3)
	Distribute fruits evenly into steam dish. This programme is suitable for all kinds of sliced fruits or berries.		
Frozen ready meal		0.8-1.2	Wire rack (1)
	Put the dish uncovered on the wire rack.		

Using the Auto Cook Mode (Continued)

Category: Special

Food item	Sub item	Weight (kg)	Accessory (Shelf level)
Desinfection	Baby bottles	2-3	Wire rack (2), Multi pan (1)
	Put open bottles horizontally on rack, with the opening to the back of the oven. Be careful taking out hot bottles.		
Baby Food	Warming	0.1-0.2 0.2-0.3	Perforated steam dish with solid steam dish (3)
	Put food into a deep ceramic dish. Do not cover.		

Category: Egg dishes

Food item	Sub item	Weight (kg)	Accessory (Shelf level)
Eggs	Soft	0.1-0.6	Perforated steam dish with solid steam dish (3)
	Pierce a hole in medium sized eggs (M). Put 2-10 eggs on the steam dish. If you like more firm eggs, leave the eggs to stand for a couple of minutes.		
	Hard	0.1-0.6	Perforated steam dish with solid steam dish (3)
	Pierce a hole in medium sized eggs (M). Put 2-10 eggs on the steam dish. If you like more firm eggs, leave the eggs to stand for a couple of minutes.		
	Poached	0.2-0.4	Perforated steam dish with solid steam dish (3)
	Grease small glass or ceramic round dishes with vegetable oil. Put each egg without shell into a round dish.		

Using the Auto Cook Mode (Continued)

Category: Convenience

Food item	Sub item	Weight (kg)	Accessory (Shelf level)
Frozen	Pizza	0.3-0.35 0.4-0.45	Multi pan (1)
	Place one frozen pizza on the multi pan.		
	Oven chips	0.4-0.45	Multi pan (1)
	Distribute frozen chips (suitable for preparation in oven) evenly on the multi pan.		
	Fish Fingers	0.3-0.5	Multi pan (1)
	Distribute frozen fish fingers evenly on the multi pan.		
	Potato Croquettes	0.4-0.6	Solid steam dish (2)
	Distribute frozen potato croquettes evenly on the solid steam dish.		
	Broccoli	0.2-0.6	Perforated steam dish with solid steam dish (3)
	Put frozen broccoli on the steam dish.		
	Green Beans	0.2-0.6	Perforated steam dish with solid steam dish (3)
	Put frozen green beans on the steam dish.		
	Peas	0.2-0.6	Perforated steam dish with solid steam dish (3)
	Put frozen peas on the steam dish.		
	Spinach Cubes	0.3-0.5	Wire rack (1)
	Put frozen spinach cubes in a flat glass pyrex dish. Stir after steaming.		
	Dim Sum	0.2-0.4	Perforated steam dish with solid steam dish (3)
	Grease the steam dish with vegetable oil. Put frozen dim sum on the steam dish.		
	Ready Yeast Dumplings	0.3-0.6	Perforated steam dish with solid steam dish (3)
	Grease the steam dish with vegetable oil. Put frozen ready yeast dumplings on the steam dish.		

Using Stage Cooking

You can use Stage Cooking if you want to use different modes after each other. You can set two or three stages and it is also possible to save the stage cooking that you have set as a 'user dish' (see page 47: 'Add your own dishes').

Stage Cooking



- 1** Turn the **Mode Knob** to "AUTO" position.

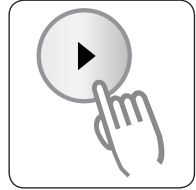
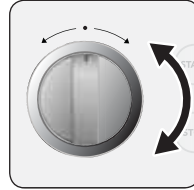

- 2** Turn the **Selection Knob** to choose 'StageCook'. Press the **Next Button** to confirm the setting.

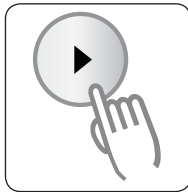
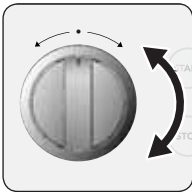

- 3** In the display you will see 'First Stage' and then the several oven modes. Turn the **Selection Knob** to choose the preferred oven mode. Press the **Next Button** to confirm.

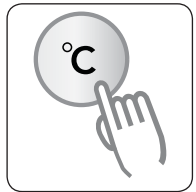
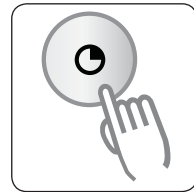

- 4** If desired, adjust the cook time and/ or the temperature (if available). See page 21 and 22.

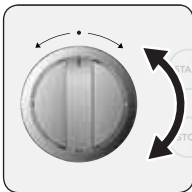
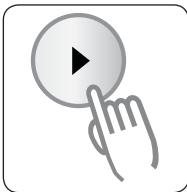

- 5** Press the **Next Button** to confirm the first stage. In the display you will see 'Second Stage' and then the several oven modes. Turn the **Selection Knob** to choose the preferred oven mode for the second stage. Press the **Next Button** to confirm.

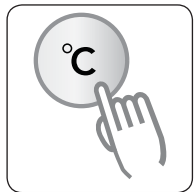
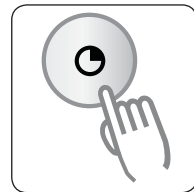

- 6** If desired, adjust the cook time and/ or the temperature (if available). See page 21 and 22.

Using Stage Cooking (Continued)

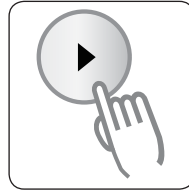
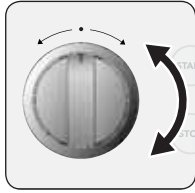
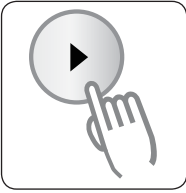

- 7** Press the **Next Button** to confirm the second stage. In the display you will see 'Third Stage' and 'Press Start'. Turn the **Selection Knob** to choose 'Third stage' if you want to add a third stage or choose 'Press Start' if you want to start the stage cooking.

- 8** Press the **Next Button** to confirm.

Go to step 9 if you want to add the third stage.

Go to step 12 if you want to start the stage cooking with two stages.

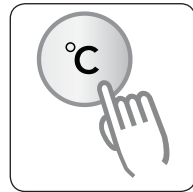
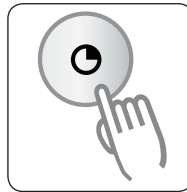
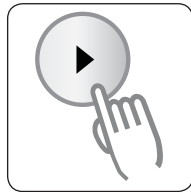
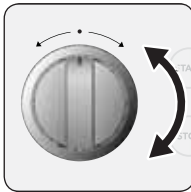

- 9** If you want to add the third stage, turn the **Selection Knob** to choose the preferred oven mode for the third stage. Press the **Next Button** to confirm.

- 10** If desired, adjust the cook time and/or the temperature (if available). See page 21 and 22.

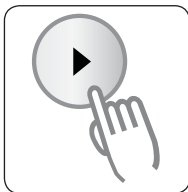

- 11** Press the **Next Button** to confirm the third stage.

- 12** Press the **Start Button** to start the stage cooking.

Add your Own Programmed Dishes

You can program 10 of your own dishes and save it as a 'user dish'.

Add your own dish

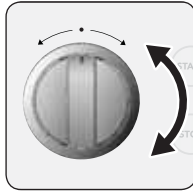
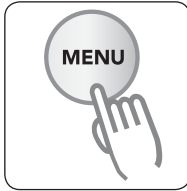

1 Press the **Menu Button** and turn the **Selection Knob** to choose 'Dishes'.

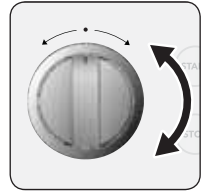
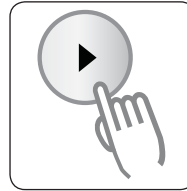

2 Press the **Next Button** to confirm. Turn the **Selection Knob** to choose 'Add'.

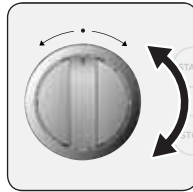
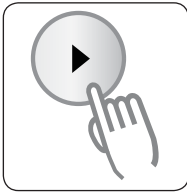

3 Press the **Next Button** to confirm. In the display you will see 'Choose Name'. Enter the first character of the name of your dish by turning the **Selection Knob**. Press the **Next Button** and enter the second character, etc. If you have entered the name completely; wait for  to appear after the name and press the **Next Button** to confirm the setting.

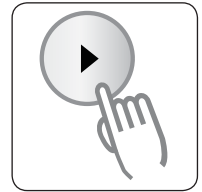
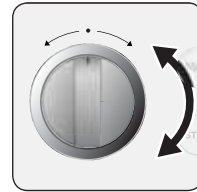

4 In the display you will see 'Choose preparation' and then the several oven modes. Turn the **Selection Knob** to choose the preferred oven mode. Press the **Next Button** to confirm.

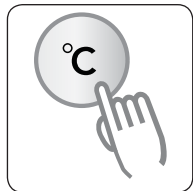
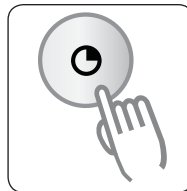

5 If desired, adjust the cook time and/ or the temperature (if available). See page 21 and 22.

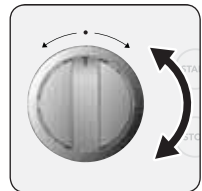
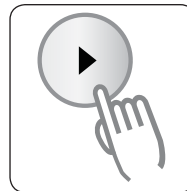

6 Press the **Next Button** to confirm. Turn the **Selection Knob** to choose 'Add Stage' (go to step 7) or 'Save Dish' (go to step 12).

Add your Own Programmed Dishes (Continued)

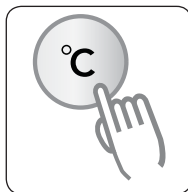
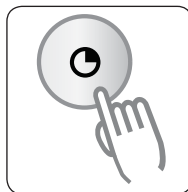
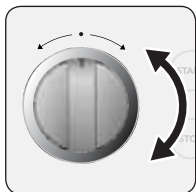
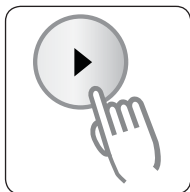

7 Press the **Next Button** to confirm. Turn the **Selection Knob** to choose the preferred oven mode for the second stage. Press the **Next Button** to confirm.

8 If desired, adjust the cook time and/or the temperature (if available). See page 21 and 22.

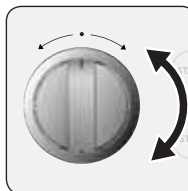
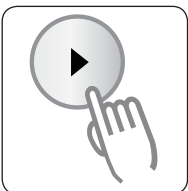
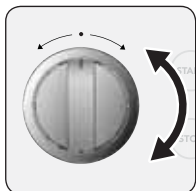
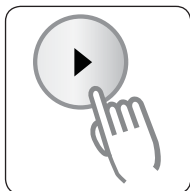

9 Press the **Next Button** to confirm. Turn the **Selection Knob** to choose 'Add Stage' (go to step 10) or 'Save Dish' (go to step 12).

10 Press the **Next Button** to confirm. Turn the **Selection Knob** to choose the preferred oven mode for the third stage. Press the **Next Button** to confirm.

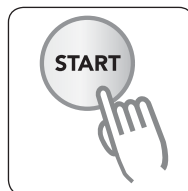
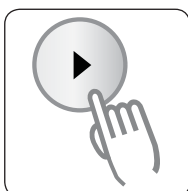
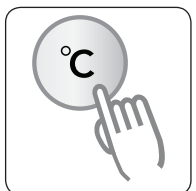
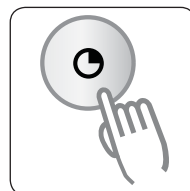

11 If desired, adjust the cook time and/or the temperature (if available). See page 21 and 22.

12 If all the settings are done; press the **Next Button** and then the **Start Button** to confirm. Now your dish is added to the Auto Cook Programs.

- During programming your own dish, you can go back by pressing the **Back Button**.
- It is not possible to change the settings of the added dishes after you have pressed the **Start Button**. You have to delete your own dish (see page 50) and add it again with the new settings.

Choose your Own Programmed Dish



- 1** Turn the **Mode Knob** to “**AUTO**” position.

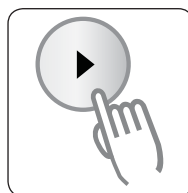
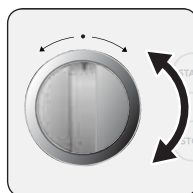

- 2** Turn the **Selection Knob** to choose ‘User Dishes’. Press the **Next Button** to confirm the setting.

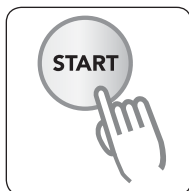
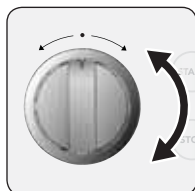

- 3** Turn the **Selection Knob** to choose your own programmed dish. Press the **Start Button** to start the cooking of your dish.

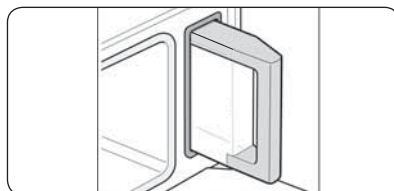

- 4** Fill the water tank up to the maximum line if you see the symbol  in the display and place it back. Place your food into the cooking cavity.

Skip Preheating

If you start cooking in the Auto Cook Mode, you might see ‘Preheating’ in the display. You can skip the preheating by pressing the **Next Button** and then turn the **Selection Knob** to choose ‘No’. Press the **Next Button** again to confirm. The combi steam oven will now skip the preheating (‘preheating’ will disappear in the display).

Delete your Own Programmed Dish

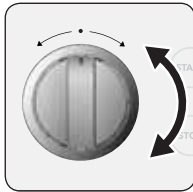
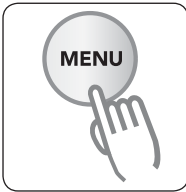

1 Press the **Menu Button** and turn the **Selection Knob** to choose 'Dishes'.

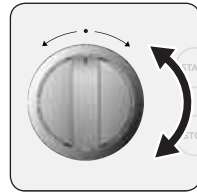
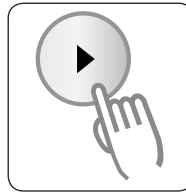

2 Press the **Next Button** to confirm. Turn the **Selection Knob** to choose 'Delete'.

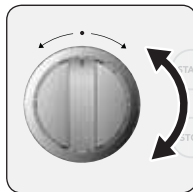
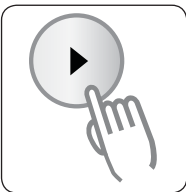

3 Press the **Next Button** to confirm. Turn the **Selection Knob** to choose your own programmed dish.

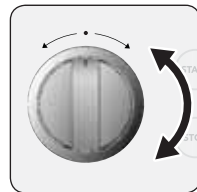
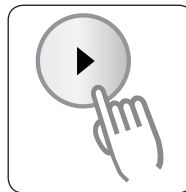

4 Press the **Next Button** to confirm. Turn the **Selection Knob** to choose 'Delete'.

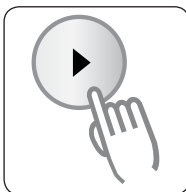

5 Press the **Next Button** to confirm. Press the **Start Button** to delete your own programmed dish.

Using the Defrost Mode

Defrost Mode Setting

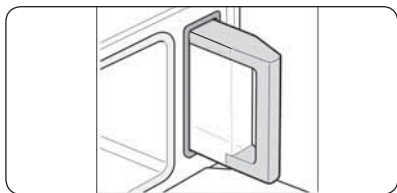

1 Fill the water tank up to the maximum line and place it back. Then place your food into the cooking cavity.

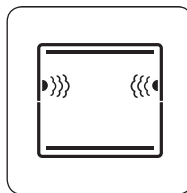

2 Turn the **Mode Knob** to Defrost mode position * (default cook time 20 min. temperature 50 °C).

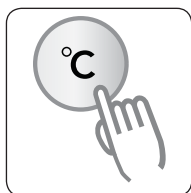
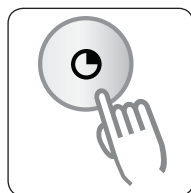

3 If desired, adjust the cook time, delayed start time and/or the temperature (if available). See page 21 and 22.



4 Press the **Start Button**. The combi steam oven will start.

Using the Defrost Mode (Continued)

Defrost Setting

Use settings and times in this table as guide lines for defrosting.

We recommend to always fill the water tank with fresh water to the maximum level.

Remove all kind of package material before defrosting!

After defrosting, let the food stand at room temperature for 15-30 minutes for an even distribution of the heat.

Food Item	Defrost mode (°C)	Accessory (shelf level)	Time (min.)
Minced Meat 500 g (covered)	50 °C	Grill insert with multi pan (1)	25-35
Roast Beef / Minced Meat (covered) 1.0 kg	50 °C	Grill insert with multi pan (1)	70-90
Chicken Pieces 500 g	50 °C	Grill insert with multi pan (1)	25-30
Whole Chicken 1.1 kg	50 °C	Grill insert with multi pan (1)	50-70
Fruit / Berries	50 °C	Perforated steam dish together with solid steam dish (3)	13-18
Fish Fillet	50 °C	Perforated steam dish together with solid steam dish (3)	15-25

Important

- 1) After defrosting meat (particularly poultry), operate the empty oven about 10 minutes in the hot air mode (200 °C) for killing bacteria in the cavity.
- 2) Do not refreeze food once it has thawed.

Using the Keeping Warm Mode

Keeping Warm Mode Setting

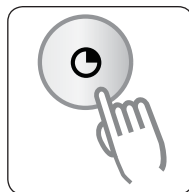
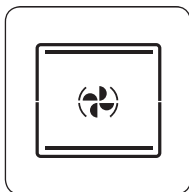

1 Turn the **Mode Knob** to Keeping Warm mode position  (default cook time 5 min.).

2 If desired, adjust the cook time and/or the delayed start time (if available). See page 21 and 22.

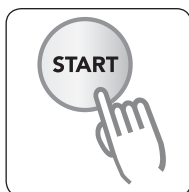

3 Press the **Start Button**. The combi steam oven will start.

Setting the Water Hardness

It is necessary to descale your appliance at regular intervals. This is the only way to prevent damage. Your appliance has a system that automatically displays when it needs descaling. It is preset to a water hardness 4. Change the value if your water is softer.

Checking the water hardness

Information on the hardness of the water in your area can be obtained from the local water board.

Changing the water hardness

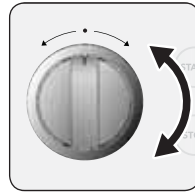
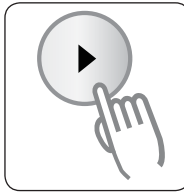
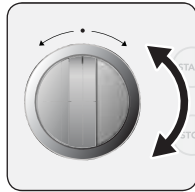
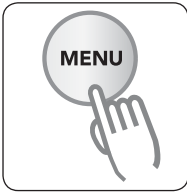

1 Press the **Menu Button** and turn the **Selection Knob** to choose 'Water hardness'.

2 Press the **Next Button** to confirm. Turn the **Selection Knob** to choose the desired water hardness.



3 Press the **Start Button**.
▶ The appliance is now programmed to provide the descaling warning when necessary, based on the actual hardness of the water.

Display	Type	PPM	French deg. (°df)	German deg. (°dH)
1	Very soft water	0 - 105	0 - 11	0 - 6
2	Soft water	125 - 230	12 - 23	7 - 13
3	Hard water	250 - 350	24 - 36	14 - 20
4 (Default)	Very hard water	> 375	> 37	> 21

Descaling

When you see the message  on the control panel, the machine needs to be descaled.

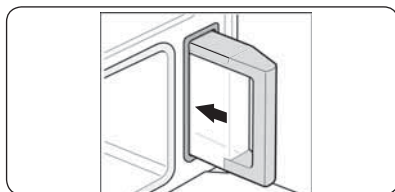
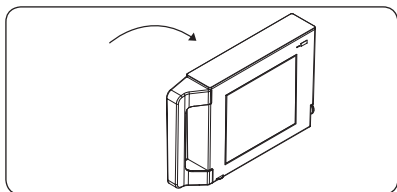

1 Pour in 100 ml descaler supplied with the machine and fill up to the maximum line with fresh water. Mix thoroughly.

2 Pour the mixed water into the water tank and close the lid before installing it into the main unit.

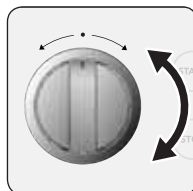
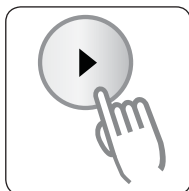
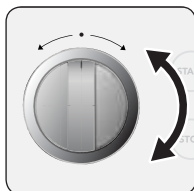
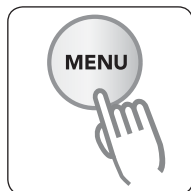

3 Press the **Menu Button** and turn the **Selection Knob** to choose 'Cleaning'.

4 Press the **Next Button** to confirm. Turn the **Selection Knob** to choose 'Decalcify'.

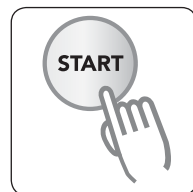
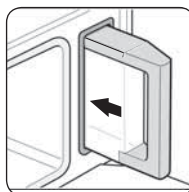
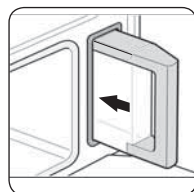

5 Press the **Start Button**.
▶ The appliance starts descaling. When it has progressed for about 30 minutes, the machine displays '10:00' and stops operating with a beep. Remove the tank and empty any remaining water.

6 Wash the tank with water and fill up to the maximum line with water. Close the lid and install it into the main unit. Press the **Start Button**.
▶ A rinsing process takes place with clean water.

Descaling (Continued)

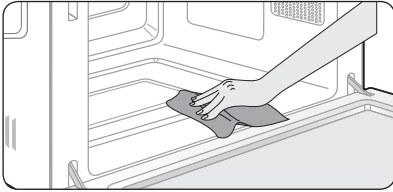

- 7** When done, the machine will make a beep. Empty both the tank and the drip tray and clean the tank with water. Open the door and wipe inside the cooking cavity with a dry cloth.

Note

- We advise to use NOKALK/DLS when you descale the machine. NOKALK/DLS is a highly effective descaler made exclusively from natural, totally biodegradable substances. It is non-corrosive, non-aggressive and has no environmental impact. As well as being an effective descaler, it also has an antimicrobial sanitising action, thus helping to ensure the hygiene of the machine's internal components, preserve the taste of the food over time and extend the working life of the machine.
- For subsequent descaling operations with NOKALK/DLS, descaling solvent can be purchased from **www.atag.nl**
- Water which is used for steam cooking, contains calcium and magnesium. Through heating, water evaporates and only the floating materials (minerals) remain (not harmful to humans).
- If the descaling cycle is interrupted before completion, the programme must be started again from the beginning.

Using the Steam Clean Feature

The Steam Clean feature allows you to sanitize your oven in just 10 minutes. The STEAM CLEAN process takes 7 minutes, and the standby time for the process is 3 minutes. In these 3 minutes the steam will soak all the leftovers and you can wipe them from the ceiling or walls with a soft cloth.

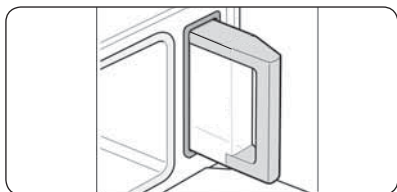

1 Fill the water tank up to the maximum line and place it back.

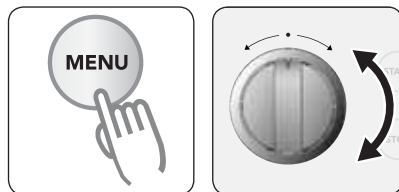

2 Press the **Menu Button** and turn the **Selection Knob** to choose 'Cleaning'.

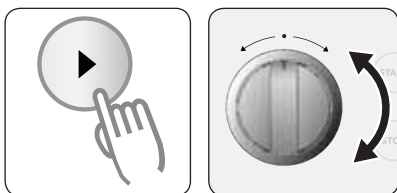

3 Press the **Next Button** to confirm. Turn the **Selection Knob** to choose 'Steam clean'.



4 Press the **Start Button**. The combi steam oven will start automatically.

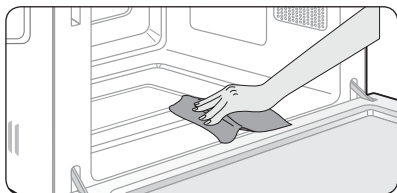

5 When the process is finished: open the door and wipe inside the cooking cavity with a dry cloth.

Important

- Use this feature only when the oven has cooled completely to room temperature.
- DO NOT use distilled water.
- DO NOT use high-pressure water cleaners or steam jet cleaners for safety reasons.

Cleaning and Care

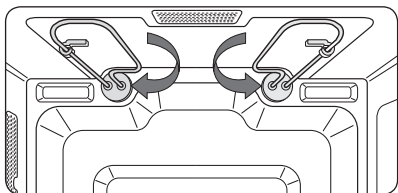

1 Cleaning the **top grill**

- ▶ Opening the top grill to the left or right, as shown in the figure, will facilitate cleaning. (When cleaning is finished, make sure to close the grill).

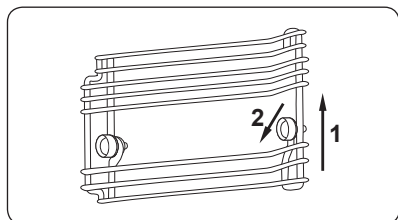
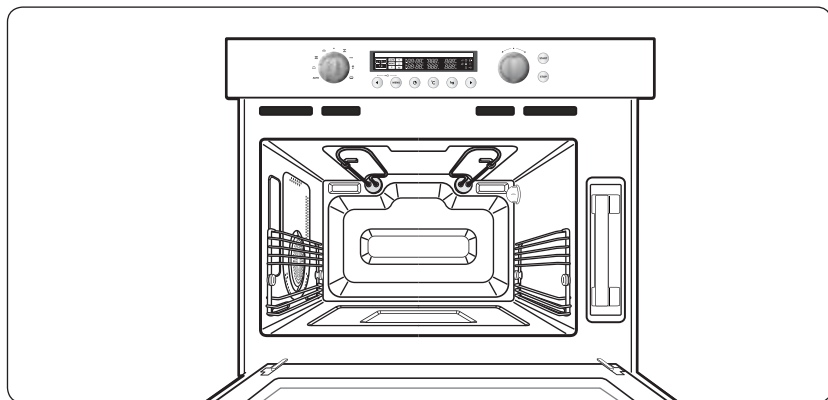

2 Cleaning inside the **cavity**.

- ▶ Lift up both left and right shelves at the front (1). Move them towards the middle (2) and pull them out. Wipe any leftovers from the ceiling or walls using a neutral cloth dipped in detergent.
- ▶ When completed, install both shelves back into the correct positions.
- ▶ Even solid, difficult stains or dry leftovers can be removed by using the steam clean process.

Cleaning and Care (Continued)

3 Cleaning the **oven surface, control panel and window**

- ▶ The surface of the oven can be wiped with a wet dish towel, followed by a dry cloth to remove the water completely.
- ▶ Do not use force when cleaning the control panel as it can be damaged while cleaning.
- ▶ Clean the transparent window with a neutral detergent-dipped dish towel and then with a dry cloth until no water remains.

4 Cleaning the **water tank and the tray**

- ▶ Wipe them with a sponge dipped in a neutral detergent and then rinse them with water.

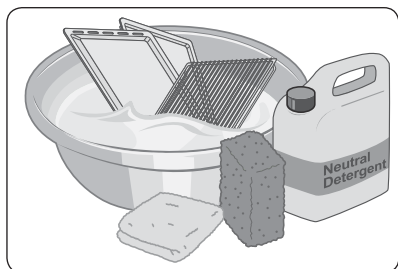

5 Cleaning the **accessories**.

- ▶ Wipe them with a neutral detergent and dry them before inserting them back into the cooking cavity.
- ▶ Do not use force on the accessories when wiping them with a scrubber, as this may damage the coated surface.

WARNING:

- NEVER use benzene, thinner or a metal scrubber to clean. Otherwise, it can cause discoloration or damage to the surface.
- Do not spray water onto the machine when cleaning it. This can lead to electric shock or fire.
- Do not expose the water tank or tray to direct sunlight to dry it. This can result in malformation or damage.

Cleaning and Care (continued)

Removing the Cooking Compartment

You can remove the oven door for easier cleaning.



Do not reach into the door hinges. There is a risk of injury.

1. Open the cooking compartment door fully.
2. Move the two locking levers up on the left and right-hand sides.
3. Close the cooking compartment door halfway. With both hands, grip the top of the door on the left and right-hand sides. Close the door a little more and pull it out.

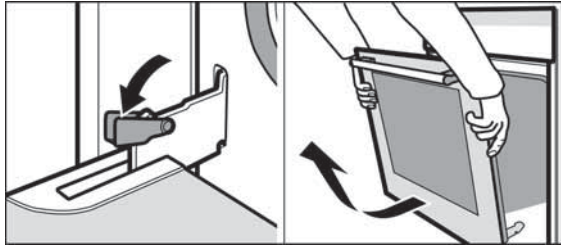

Fitting the Cooking Compartment Door

Refit the cooking compartment door after cleaning.

1. Insert the door hinges straight into the openings on the left and right-hand sides of the cooking compartment. The notch on the hinge must engage on both sides.

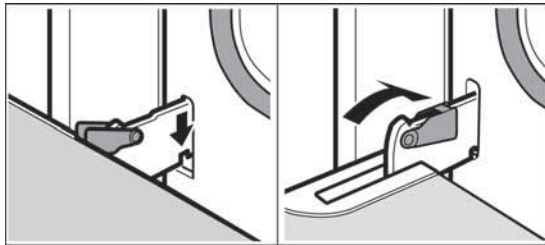

2. Open the cooking compartment door fully and fold the locking lever upwards.
3. Close the cooking compartment door.

Changing the Oven Lamp

Replacing the oven lamp and cleaning the glass cap

1. Take off the cap by turning counterclockwise.
2. Remove the metal ring and the sheet ring and clean the glass cap.
3. If necessary, replace the bulb with a 25 Watt, 230 V, 300 °C heat resistant oven light bulb.
4. Fit the metal and the sheet ring to the glass cap.
5. Reinstall the glass cap.

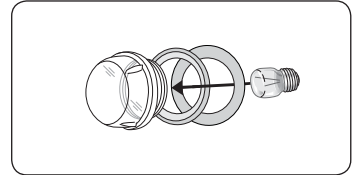
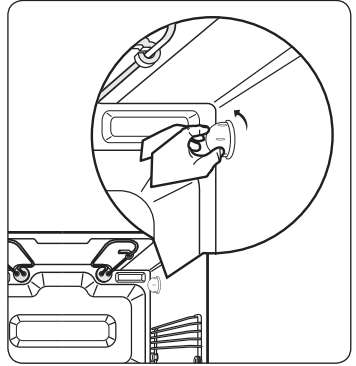

Error Codes

Error Code	General Functions
	TEMP SENSOR OPEN In case the value of the temperature sensor is less than 5 °C during operation / cancellation.
	TEMP SENSOR SHORT In case the value of the temperature sensor is more than 250 °C during operation / cancellation.
	UNFINISHED PREHEAT In case the oven has not reached the desired temperature although a certain amount of time has passed (unfinished preheating).
	OVER 250 °C DURING OPERATION OF CONVECTION In case the temperature rises over 250 °C during operation of hot air mode.
	STEAM SENSOR OPEN In case the value of the temperature sensor is less than 30 °C after operation of the steam heater for a certain time.
	STEAM SENSOR SHORT
	DESCALE MAX. TIME OVER (or STEAM USE MAX TIME OVER) In case the steam operating time after the descaling message has been passed. The oven must be descaled before you can use it (see page 55).

If any of these errors occur, please contact ATAG Customer Service.

Technical Specifications

Model	SQ4211TUU / SQ4292TUU
Power Source	230 V ~ 50 Hz
Power Consumption	
Maximum Power	3200 W
Grill	1530 W
Hot air	2050 W
Steam	1700 W - 2200 W
Cooling Method	Cooling fan motor
Dimensions (W x H x D)	
Outside	595 x 460 x 473 mm
Oven Cavity Net.	400 x 215 x 385 mm
Volume Cet.	30 litre
Volume Gross	36 litre
Weight	
Net	25 kg approx
Shipping	31 kg approx

Disposal of Package and Appliance

In the manufacturing of this appliance durable materials were used. Make sure to dispose of this equipment responsibly at the end of its lifecycle. Ask the authorities for more information regarding this.

The appliance packaging is recyclable. The following may have been used:

- cardboard;
- polythene film (PE);
- CFC-free polystyrene (PS hard foam).

Dispose of these materials in a responsible manner and in accordance with government regulations.

As a reminder of the need to dispose of household appliances separately, the product is marked with the symbol of a crossed-out wheeled dustbin. This means that at the end of its working life, the product must not be disposed of as urban waste. It must be taken to a special local authority differentiated waste collection centre or to a dealer providing this service.



Disposing of a household appliance separately avoids possible negative consequences for the environment and health deriving from inappropriate disposal and enables the constituent materials to be recovered to obtain significant savings in energy and resources.



Het toestel-identificatieplaatje bevindt zich aan de binnenkant van het toestel.

La plaque d'identification de l'appareil se trouve sur l'intérieur de l'appareil.

Das Gerätetypenschild befindet sich an der Innenseite des Gerätes.

The appliance identification card is located on the inside of the appliance.

Plak hier het toestel-identificatieplaatje.
Placez ici la plaque d'identification de l'appareil.
Kleben Sie hier das Gerätetypenschild ein.
Stick the appliance identification card here.

Houd, wanneer u contact opneemt met de serviceafdeling,
het complete typenummer bij de hand.

En cas de contact avec le service après-vente,
ayez auprès de vous le numéro de type complet.

Halten Sie die vollständige Typennummer bereit,
wenn Sie mit der Kundendienstabteilung Kontakt aufnehmen.

When contacting the service department, have the complete type number to hand.

Adressen en telefoonnummers van de serviceorganisatie vindt u op de garantietaal.

Les adresses et les numéros de téléphone du service après-vente se trouvent sur la carte de garantie.

Adressen und Telefonnummern der Kundendienstorganisation finden Sie auf der Garantiekarte.

You will find the addresses and phone numbers of the service organisation on the guarantee card.