

Hisense

life reimagined

EN (GB) (IE)

INSTRUCTIONS FOR USE

OF AN UPRIGHT FRIDGE FREEZER

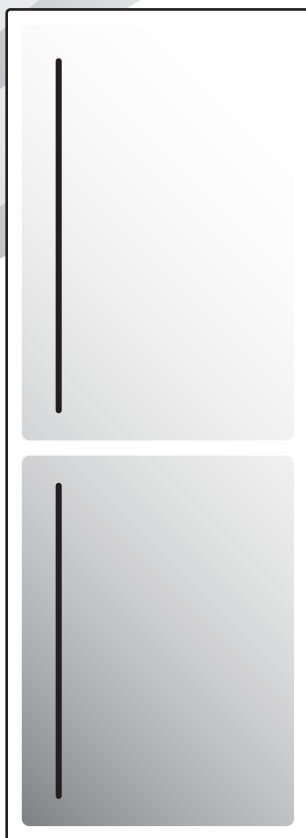

THANK YOU FOR WELCOMING OUR APPLIANCE INTO YOUR HOME

We are happy that you have chosen a Hisense appliance. Hisense is here to empower you and all your adventures with our cutting-edge technology and modern home appliances made of high-quality materials. Because we are working tirelessly on energy efficiency, by purchasing our appliance, you too are contributing to more sustainable future.

For full use of our services, warranty and other important information, please consider to register your Hisense appliance online on our website:

<https://www.hisense-europe.com>

We hope our appliance will meet and exceed your expectations.

Link to the EU EPREL database

The QR code on the energy label supplied with the appliance provides a web link to the registration of this appliance in the EU EPREL database. Keep the energy label for reference together with the user manual and all other documents provided with this appliance. It is possible to find information related to the performance of the product in the EU EPREL database using the link <https://eprel.ec.europa.eu> and the model name and product number that you can find on the rating plate of the appliance. For more detailed information about the energy label, visit www.theenergylabel.eu.

The appliance is intended solely for household use.

The refrigerator is intended for storing fresh food at temperatures above 0°C.

The freezer is intended for freezing fresh food and for long-term storage of frozen food (up to one year, depending on the type of food).

The following symbols are used throughout the manual and they have the following meanings:

 **INFORMATION!**
Information, advice, tip, or recommendation

 **WARNING!**
Warning – general danger

 **ELECTRIC SHOCK!**
Warning – danger of electric shock

 **DANGER OF FIRE!**
Warning – danger of fire

Contents

Important notes and precautions	5
Before using the appliance for the first time	5
Important safety instructions	5
Important information on the use of appliance	7
Advice for saving power with refrigeration appliances	9
Installation and connection	10
Selecting the room	10
Appliance placement	10
Connecting the appliance	12
Reversing the door opening direction	13
Description of the appliance	18
Operating the appliance	19
Control unit 1	19
Control unit 2	22
Control unit 3	24
Appliance interior equipment	31
Shelf	31
Wire bottle rack *	31
Fruit and vegetable bin with humidity control (CrispZone) *	31
Fresh Box/Chill Zone drawer *	32
Turning the Fresh Box/Chill Zone drawer into a fruit and vegetables drawer *	33
Door racks	33
MultiFlow with air ionizer (NoFrost appliances) *	34
Smart Fresh	34
Recommended distribution of food in the appliance	35
Storing food in the refrigerator	36
Important warnings regarding food storage	36
Avoid contamination of food	36
Freezing and storing frozen food	37
Freezing procedure	37
Important warnings on freezing	37
Storing industrially frozen food	37
Frozen food storage time	38
Thawing frozen food	38
Defrosting the appliance	39
Automatic refrigerator defrosting	39
Defrosting a NoFrost freezer	39
Manual defrosting of the NoFrost freezer	39
Cleaning the appliance	41
Troubleshooting	42
Information about appliance noise	45

Important notes and precautions

Before using the appliance for the first time

Before connecting the appliance to the power mains, please read carefully the instructions for use which describe the appliance and its correct and safe use. The instructions apply to several appliance types/models; thus, settings or equipment may be described herein which is not available in your appliance. We recommend saving this instruction manual for future reference and attach it to the appliance if it is sold in the future.

Check for any damage or irregularities on your appliance. If you find your appliance is damaged, notify the retailer from which you have purchased the appliance.

Before connecting the appliance to the power mains, let the appliance rest in a vertical position for a minimum of 2 hours. This will reduce the possibility of operation faults due to the effect of transport on the cooling system.

Important safety instructions



DANGER OF FIRE!

WARNING! Risk of fire/flammable materials.

The appliance must be connected to the power mains and grounded in compliance with the effective standards and regulations.

WARNING! Do not locate multiple portable socket-outlets or portable power supplies at the rear of the appliance.

Before cleaning the appliance, unplug it from the power mains (unplug the power cord from the wall outlet).



ELECTRIC SHOCK!

WARNING! If the supply cord is damaged, it must be replaced by the manufacturer, its service agent or similarly qualified persons in order to avoid a hazard.



ELECTRIC SHOCK!

WARNING! When positioning the appliance, ensure the supply cord is not trapped or damaged.



ELECTRIC SHOCK!

If LED lighting does not work, call a service technician. Do not attempt a repair of the LED lighting yourself, as there is danger of contact with high voltage!



WARNING!

WARNING! Do not use electrical appliances inside the food storage compartments of the appliance, unless they are of the type recommended by the manufacturer.

 **WARNING!**
WARNING! Do not use mechanical devices or other means to accelerate the defrosting process, other than those recommended by the manufacturer.

 **WARNING!**
WARNING! To avoid any hazard resulting from poor stability of the appliance, make sure it is installed as instructed.

Freeze burn hazard

To avoid freeze burn, never put frozen food in your mouth and do not touch frozen food.

Safety of children and vulnerable persons

The appliance is not intended for use by persons (including children) with reduced physical, sensory or mental capabilities, or lack of experience and knowledge, unless they have been given supervision or instruction concerning use of the appliance by a person responsible for their safety.

Children should be supervised to ensure that they do not play with the appliance.

Cleaning and user maintenance shall not be made by children without supervision.

Remove the packaging intended to protect the appliance or particular parts during transport and keep it outside the reach of children. It presents danger of injury or suffocation.

When removing a used appliance, disconnect the power cord, remove the door, and leave the shelves in the appliance. This will prevent children from locking themselves in the appliance.

For European markets only

This appliance can be used by children aged from 8 years and above and persons with reduced physical, sensory or mental capabilities or lack of experience and knowledge if they have been given supervision or instruction concerning use of the appliance in a safe way and understand the hazards involved.

Children shall not play with the appliance.

Cleaning and user maintenance shall not be made by children without supervision.

Children aged from 3 to 8 years are allowed to load and unload refrigerating appliances.

Warning regarding the refrigerant

The appliance contains a small amount of an environmentally friendly yet flammable gas R600a. Make sure that no parts of the cooling system are damaged. A gas leak is not hazardous to the environment, but it could cause eye injury or fire.

In case of a gas leak, ventilate the room thoroughly, disconnect the appliance from the power mains, and call a service technician.

Important information on the use of appliance

WARNING! This appliance is intended to be used in household and similar applications such as:

- staff kitchen areas in shops, offices and other working environments;
- farm houses and by clients in hotels, motels and other residential type environments;
- bed and breakfast type environments;
- catering and similar non-retail applications.



WARNING!

WARNING! Keep ventilation openings, in the appliance enclosure or in the built-in structure, clear of obstruction.

The appliance may not be used outdoors and it may not be exposed to rain.

Do not store explosive substances such as aerosol cans with a flammable propellant in this appliance.

If the appliance will be out of use for an extended period of time, switch it off using the relevant button, and unplug it from the power mains. Empty the appliance, defrost it, clean it, and leave the door ajar.

In case of an error or power supply failure, do not open the freezer compartment unless the freezer has not operated for over 16 hours. After this period, use the frozen food or provide sufficient cooling (e.g. a replacement appliance).

Technical information on the appliance

Rating plate can be found in the appliance interior. It indicates data on voltage, gross and net volume, type and amount of refrigerant, and information on the climate classes.

If the language on the rating plate is not the language of your choice or the language of your country, replace it with the one supplied.



WARNING!

WARNING! Do not damage the refrigerant circuit.

Advice for saving power with refrigeration appliances

- Install the appliance as specified in the instruction manual.
- Do not open the door more often than necessary.
- Occasionally make sure air circulation underneath the appliance is unobstructed.
- If the gasket is damaged or does not provide a perfect seal for any reason, have it replaced as soon as possible.
- Store the food in tightly sealed containers or appropriate packaging.
- Before placing the food in the refrigerator, allow it to cool down to room temperature.
- Defrost frozen food in the refrigerator compartment.
- To make use of the entire freezer compartment interior volume, remove some of the drawers as described in the instruction manual.
- Make sure the layout of shelves in the compartment is uniform and that the food is placed so that the air can freely circulate in the appliance interior (observe the recommended placement of food as described in the instructions).

Installation and connection

Selecting the room

- Install the appliance in a dry and well ventilated room. The appliance will operate correctly if the environment temperature is in the interval specified in the table. The appliance class is indicated on the rating plate / label with the basic information on the appliance.

Description	Class	Ambient temperature range °C	Relative humidity
Extended temperate	SN	+10 to +32	≤75%
Temperate	N	+16 to +32	
Subtropical	ST	+16 to +38	
Tropical	T	+16 to +43	



INFORMATION!

This appliance is not intended to be used as a build-in appliance.



INFORMATION!

Do not place an appliance in a room where temperature can drop to below 5 °C as this may cause abnormal appliance operation or failure!

- After the installation, the appliance mains plug should be accessible!
- Do not place the appliance near appliances or devices radiating heat, such as a cooker, a stove, a radiator, water heater etc., and do not expose it to direct sunlight. The appliance should stand at least 3 cm away from an electric or gas cooker or at least 30 cm away from an oil or solid fuel stove. If the distance between such source of heat and the appliance is smaller, use an insulating panel.

Note: Place the appliance in a sufficiently large room. There should be at least 1 m³ of space per 8 grams of refrigerant. Amount of refrigerant is indicated on the rating plate in the appliance interior.

Appliance placement

Appliance installation should be carried out by at least two persons to avoid any personal injury or damage to the appliance.

- The appliance must stand level or tilted slightly to the back. It should be stable and placed on a solid base. At the front, the appliance is fitted with two adjustable feet that can be used to level the appliance. At the rear side, casters allow for easier installation of the appliance (only with some models).

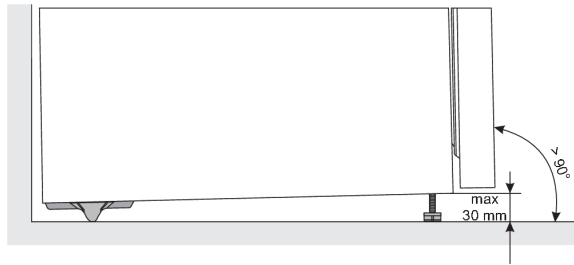

- After you have levelled the appliance using the adjustable feet, adjust the additional foot for extra stability of the appliance.
- Do not expose the appliance to direct sunlight and do not place it near sources of heat. If this cannot be avoided, install an insulation panel.

- The appliance is intended for free-standing installation. To reach the rated/minimum power consumption, always provide 50 mm of clearance between the wall and the back of the appliance, and above the appliance. Also allow adequate air circulation on either side of the appliance and above it.
- The appliance can also be placed adjacent to or between kitchen cabinets or cupboards, or adjacent to a wall. In case of such placement, the appliance will operate flawlessly; however, power consumption could increase. Observe the minimum clearance above and behind the appliance, as indicated in the figure.
- Take into account the space or clearance required to open the appliance door, in order to allow the drawers and shelves to be pulled out or removed (see installation diagram).

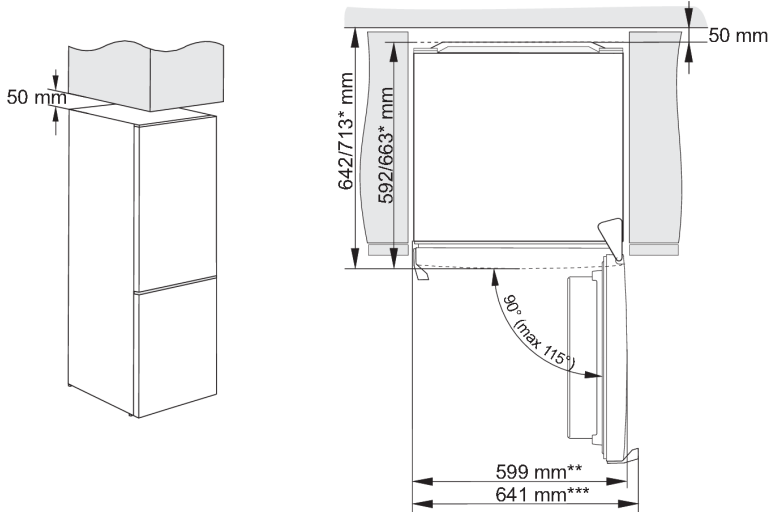

* depending on the model

** model with integrated handle

*** model with external/protruding handle

Connecting the appliance

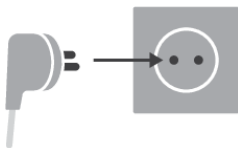





- Connect the appliance to the power mains using the power cord. The wall outlet should be fitted with a ground contact (safety socket). Nominal voltage and frequency are indicated on the rating plate/label with basic information on the appliance.
- The appliance must be connected to the power mains and grounded in compliance with the effective standards and regulations. The appliance will withstand short-term deviations from the nominal voltage, but not more than +/- 6%.

Reversing the door opening direction

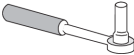
The direction in which the appliance door opens can be reversed.

Note: Disconnect the appliance from the power mains before reversing the door opening direction.

Tools required:	
	Socket wrench No. 8,
	Cross-point screwdriver
	Flat screwdriver
	Spanner No. 8

Note:

- If the appliance has to be tilted to allow access to parts on the bottom, ask another person for assistance or gently place the appliance on some soft padding to prevent damaging it. To reverse the opening direction, proceed as follows.



INFORMATION!

The door reversing procedure described below pertains to models with control unit installed inside the appliance or on the appliance door. Therefore, observe the part relevant for your appliance in steps 2, 3, 6 and 15.

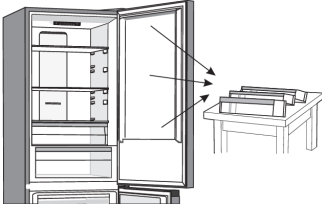
1.  Place the appliance in an upright position. Open the top door and remove the door racks (to prevent damaging them during the procedure). Close the door.

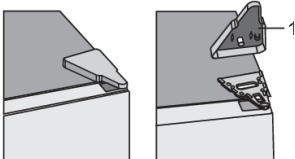
2. A.  Control unit inside the appliance:
Remove the top hinge cap (1).

B.

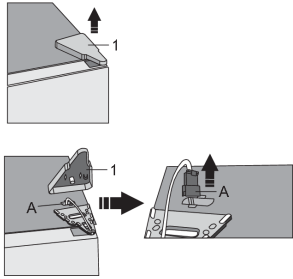

Controls on the appliance door:
Remove the top hinge cap (1). Be particularly careful not to damage the connector (A). Unplug the connector (A).

3. A.

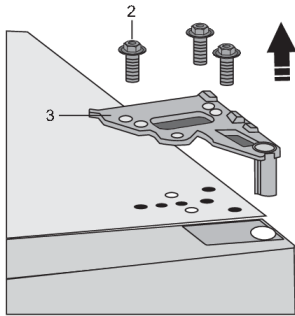

Controls in the appliance interior: Undo the screws (2) and remove the hinge (3). Hold the door while doing this to prevent it from falling.

B.

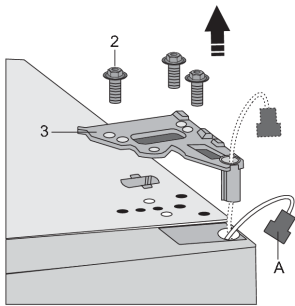

Controls on the appliance door: Undo the screws (2) and remove the hinge (3). Run the connector (A) through the hole in the hinge. Hold the door while doing this to prevent it from falling.

4.



Remove the top door from the middle hinge by carefully lifting it straight up. Lay the door onto a smooth surface.

5.

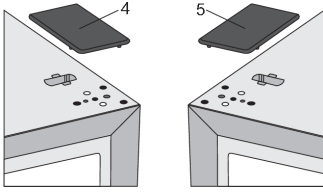

Take the (right) cap/cover (4) from the bag and place it on the spot from which the top hinge was removed. Remove and save the cap/cover from the other side (5) to which the hinge will be relocated.

6. A.

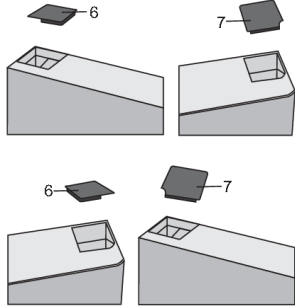

Controls in the appliance interior:
Remove the cap (6) from the left side of the top door. Then, remove the cap (7) from the right side of the top door. Place the cap (7) on the left side of the top door and place the cap (6) on the right side of the top door.

B.

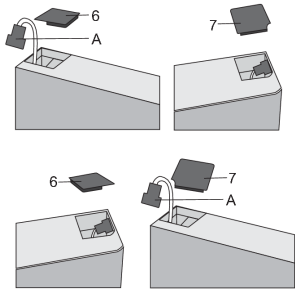

Controls on the appliance door:
Remove the cap (6) from the left side of the top door and pull out the connector (A). Then, remove the cap (7) from the right side of the top door. Place the cap (7) on the left side of the top door and place the cap (6) on the right side of the top door.

7.

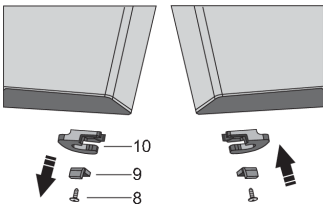

Undo the screw (8) and remove the door retainer (10) and the door stop (9). Then, use a screw (8) to install the door retainer supplied in the bag, and the door stop (9). Keep the door retainer (10) in case you need it later.

8.

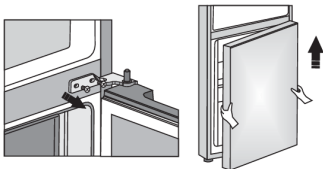

Undo the screws from the middle hinge and remove it. Then, remove the bottom door from the bottom hinge.

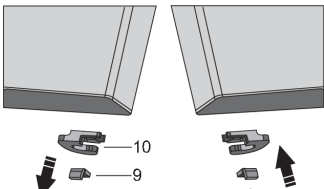
9.  Lay the bottom door onto a smooth surface. Undo the screw (8) and remove the door retainer (10) and the door stop (9). Then, use a screw (8) to attach the door retainer supplied in the bag, and the door stop (9). Keep the door retainer (10) in case you need it later.

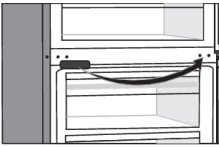
10.  Remove the middle hinge cap and replace it on the opposite side.

11. Tilt the appliance backwards and remove the adjustable foot (11).

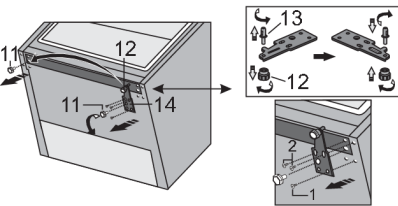
12.  Undo the three screws on the bottom hinge (14) and remove it. Remove the extra foot (12) from the bottom hinge pin (13). Unscrew the pin (13) from the bottom hinge and screw it onto the opposite side of the hinge, complete with the extra foot (12).

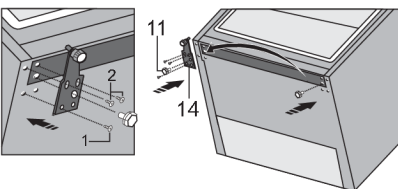
13.  Attach the hinge (14) onto the opposite side using the screws. The screws should be attached in the order shown in the figure below. First, tighten the screw 1, followed by screws 2. Then, screw on the adjustable feet (11).

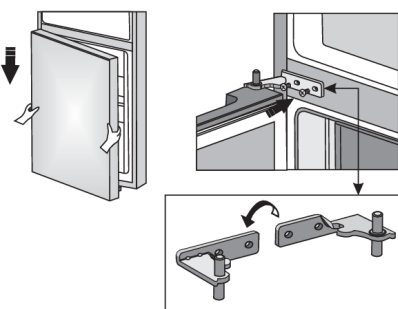
14.  Place the bottom door onto the bottom hinge and hold them in place. Rotate the middle hinge by 180°. Place the washer in the correct position and adjust the position of the middle hinge so that you can install and fix the bottom door.

15. A.

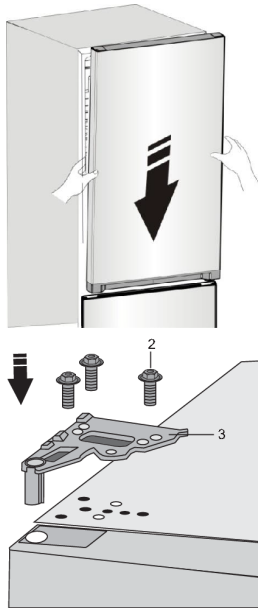

Controls in the appliance interior: Place the top door in the correct position and use the screws (2) to attach the upper hinge (3). Hold the top door in place while positioning them.

B.

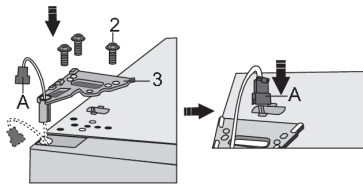

Controls on the appliance door: Correctly position the top door, run the connector (A) through the hole in the top hinge (3) and use the screws (2) to attach it. Hold the top door in place while positioning them. Reconnect the connector (A).

16.

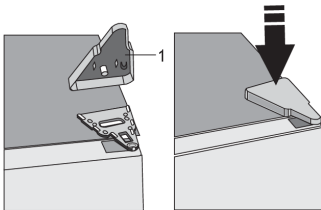

Replace the upper hinge cap (1).

17. Open the top door and replace the door rack; then, close the door.



Note: If your model has a handle, then move it to the opposite side by following the instructions below.

Remove the caps (1) and undo the two screws (2) as shown in the figure. Rotate the handle (3) by 180° and replace it on the opposite side. Then, fasten the screws (2) and replace the caps (1).

Description of the appliance

Appliance interior equipment may change according to the appliance model.

This product contains a light source of energy efficiency class G.

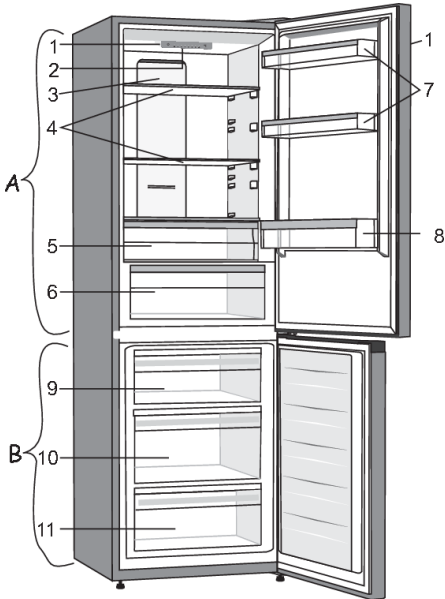

A Refrigerator

1. Control panel **
2. LED lighting
3. MultiFlow
4. Glass shelves
5. FreshBox/Chill Zone drawer *
6. CrispZone fruit and vegetables drawer with humidity control *
7. Low door racks
8. Bottle shelf

B Freezer

9. Top freezing and storage drawer ***
10. Deep SpaceBox drawer for freezing and storage
11. Bottom storage drawer

- The drawers are fitted with a system that prevents them from being unintentionally pulled out. To remove a drawer from the appliance, pull it out as far as it will go, then lift at the front and pull out completely.

* Only in some models

** In some models, the control unit is located on the door.

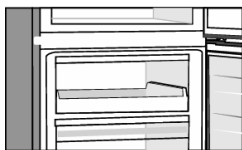

*** Some models have a tray instead of the uppermost drawer.

Operating the appliance

Control unit 1

(Controls in the appliance interior)

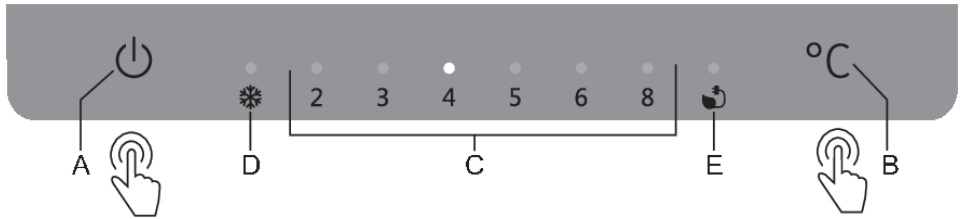

- A. **Appliance on/off key**
- B. **Temperature and extra functions settings key**
- C. **Refrigerator compartment temperature display**
The signal light above the set temperature display is lit.
- D. **Intensive freezing (fast freeze) function indicator**
If intensive freezing (freezer boost) is activated, the signal light above the **D** symbol will be lit.
- E. **Eco function indicator**
If the **Eco** function is activated, the signal light above the **E** symbol will be lit.

To set the appliance temperature or activate the **Eco** function, press the **B** key successively. The indicator cycles through the settings in a circular manner, from right to left. Three seconds after the key is released, the setting will be stored automatically.

To activate or deactivate **intensive freezing** (freezer boost), press the **B** key and hold it for a few seconds.

Switching the appliance on/off

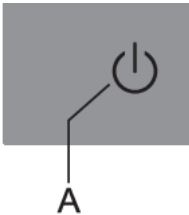

Switching the appliance on: To switch on the appliance, press the **A** key.

Switching off the appliance: Press the **A** key again and hold it for 2 seconds. The appliance will be switched off, but it will remain powered.

Adjusting the temperature in the appliance

INFORMATION!

The factory default setting is the recommended temperature of 4 °C. At this setting, the temperature in the freezer compartment will be around -18 °C.

After the appliance is switched on, it may take several hours for the set temperature to be reached. Do not place any food into the refrigerator before the temperature drops to the selected setting.

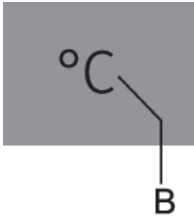

- Set the desired temperature using the **B** key.
- Set the desired temperature by successively pressing the **B** key.
- The indicator cycles through the settings in a circular manner, from right to left.

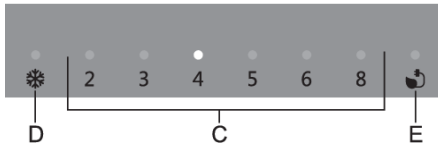

The numbers 2, 3, 4, 5, 6 and 8 indicate the temperature in degrees Celsius (°C) in the refrigerator compartment.

- The recommended temperature setting is +4 °C. At this temperature, food quality and freshness are preserved longer.
- The temperature in the refrigerator compartment also affects the temperature in the freezer compartment. For a lower temperature in the freezer compartment, set a lower temperature in the refrigerator compartment.
- If the temperature of the room where the appliance is installed is below 16 °C, we recommend setting a temperature lower than 4 °C.

Intensive freezing (super freeze) function

Use this setting after switching on the appliance for the first time, before cleaning, or 24 hours before adding a large amount of food.

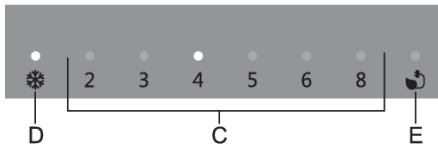

Switching on: To activate intensive freezing, press the **B** key and hold it until the signal light above the **D** symbol lights up.

INFORMATION!

When the intensive freezing function is selected, the appliance works at maximum capacity. It may then make more noise for a while.

INFORMATION!

When the intensive freezing (super freeze) function is activated, temperature may be lower both in the refrigerator and the freezer compartment.

- When intensive freezing is activated, you may still adjust the refrigerator compartment temperature by briefly pressing the **B** key.

Switching off: Press and hold the **B** key again, until the light above the **D** symbol goes off. If the intensive freezing function is not deactivated manually, it will be automatically switched off (after approximately two days), and the temperature will return to the most recently set value.

- If there is a power outage while the intensive freezing function is active the function will be restarted once power supply is restored.

Eco function

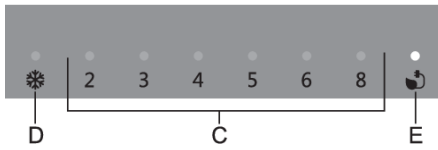

Switching on: To activate the **Eco** function, press the **B** key until light above the **E** symbol lights up. When this function is activated, the appliance operates under optimum settings.

Switching off: To switch off the Eco function, use the **B** key to select the desired temperature.

High temperature alarm

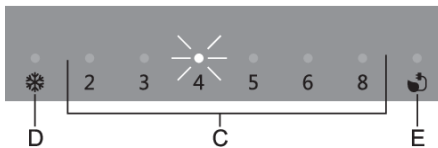

If the temperature inside the appliance is too high, acoustic alarm will be activated (intermittent tone) and the signal light above the set temperature (**C**) will start flashing.

Every time you switch on the appliance using the **A** key, a 24-hour delay in alarm operation is activated. If the appliance fails to reach a sufficiently low temperature after this period, the alarm will be activated.

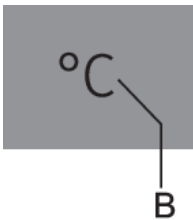

Switching off the alarm:

- To acknowledge and switch off the acoustic alarm, press the **B** key. If the alarm is not switched off, it will be activated every hour for approximately 15 minutes.
- When you press the **B** key again, it will already work as a settings adjustment key.
- The light above the set temperature **C** will flash until the appliance reaches a sufficiently low temperature.

Open door alarm

If the refrigerator or freezer compartment door is open for more than 2 minutes, an acoustic alarm (repetitive beep) will be activated. If the alarm is not switched off manually, it will be sounded for 10 minutes.

To switch off the alarm: to switch off the alarm, close the appliance door.

INFORMATION!

If you switch off the alarm by pressing the **B** key, it will be activated again after 4 minutes if the door is still open.

INFORMATION!

If you leave the door open for more than 10 minutes, then the alarm will stop and the indicator light above the display 8 will start to flash. Appliance operation will switch to safe mode in order to provide sufficient cooling and prevent food spoilage despite the open door.

Control unit 2

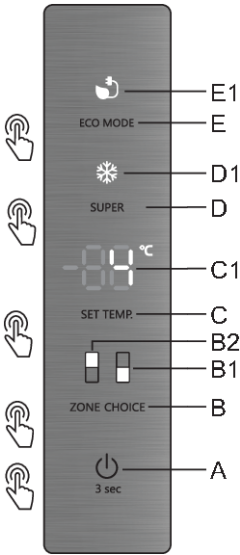

- A** Appliance on/off key
- B** Refrigerator/freezer compartment switch key
- B1** Freezer compartment display
- B2** Refrigerator compartment display
- C** Temperature setting key
- C1** Set temperature display
- D** Intensive freezing (fast freeze) on/off key
- D1** Intensive freezing (fast freeze) function indicator
- E** Eco function on/off key
- E1** Eco function indicator

Switching the appliance on/off



Switching the appliance on: Press **A** key and hold it for 3 seconds, after a buzzer sound the appliance will be turned on.

Switching off the appliance: Press the **A** key again and hold it for 3 seconds, after a buzzer sound, meanwhile the display **C1** will show "OF", the appliance will be turned off.

Adjusting the temperature in the appliance

We recommend that when you start your refrigerator for the first time, the temperature for the refrigerator is set to 4°C. If you want to change the temperature, follow the instructions below.

Caution! When you set a temperature, you set an average temperature for the whole refrigerator cabinet. Temperatures inside each compartment may vary from the temperature values displayed on the panel, depending on how much food you store and where you place them. Ambient temperature may also affect the actual temperature inside the appliance.

Refrigerator

Press **B** key (**ZONE CHOICE**), the symbol **B2** will turn on. Then press **C** key, you can set fridge temperature between 2°C and 8°C as needed, and display panel will display corresponding values according to the following sequence.

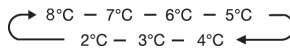

Freezer

Press **B** key (**ZONE CHOICE**), the symbol **B1** will turn on. Then press **C** key, you can set freezer temperature between -14°C and -24°C as needed, and display panel will display corresponding values according to the following sequence.

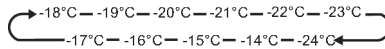

Super Freeze (SUPER)

Super Freeze will quickly lower the temperature within the freezer so food will freeze faster. This can lock in the vitamins and nutrients of fresh food and keep food fresh longer.

- You can press **D** key (**SUPER**), to get into super freezer mode.
- When super freeze mode is selected, the light will be illuminated and the freezer temperature will be set at -24°C.
- In case of the maximum amount of food to be frozen, please wait about 24 h.
- Super freeze automatically switches off after 50 hours and then the freezer temperature setting will revert back to the previous setting.

ECO function

This function makes the freezer work in a power saving mode which is useful for reducing energy consumption when you are away.

- You can press **E** key (**ECO MODE**), to get into Eco function.
- When **Eco** function is activated, the light **E1** will be illuminated. The freezer temperature will be set at -17°C and the fridge temperature will be set at 6°C.

Open door alarm

- When the door of fridge has been opened for over 2 minutes, the door alarm will sound. In case of door alarm, buzzer will sound 3 times every 1 minute and will stop alarming automatically after 8 minutes.
- To save energy, please avoid keeping the door open for a long time when using the appliance.
- The door alarm can also be cleared by closing the door.

Control unit 3

(Controls on the appliance door)

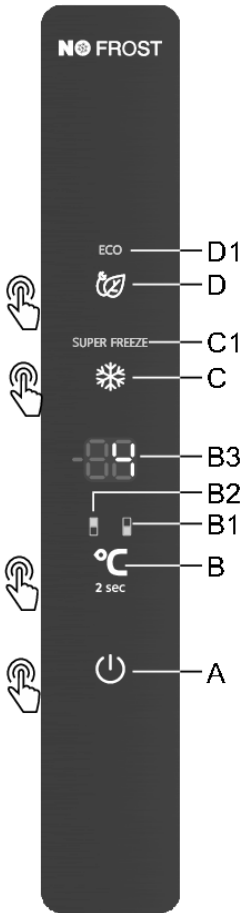

- A** Appliance on/off key
- B** Temperature adjustment key and refrigerator/freezer compartment switch key
- B1** Freezer compartment display
- B2** Refrigerator compartment display
- B3** Set temperature display
- C** Intensive freezing (fast freeze) on/off key
- C1** Intensive freezing (fast freeze) function indicator
- D** Eco function on/off key
- D1** Eco function indicator

Switching the appliance on/off



When you connect the appliance to the power mains for the first time, the appliance will be in standby mode (switched off, but powered).

Switching on the appliance: To switch on the appliance, press the **A** key.

A beep will be sounded and temperature display will appear on the display unit **B3**.

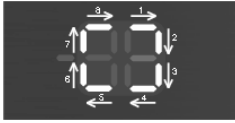

Switching off the appliance: To switch off the appliance, press the **A** key and hold it for a while (2 seconds). A beep will be sounded again and the outer segments of the display digits **B3** will light up in the clockwise direction. The appliance is in standby mode (it is still powered).

Adjusting the temperature in the appliance

☀️ INFORMATION!

- Appliance temperature is preset at the factory to the recommended setting, i.e. 4°C for the refrigerator compartment and -18°C for the freezer compartment.
- After the appliance is switched on, it may take several hours for the set temperature to be reached. Do not place any food into the refrigerator before the temperature drops to the selected setting.

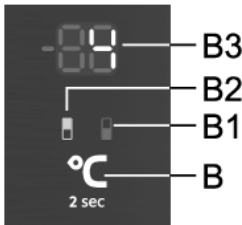

In this model, you can switch between setting the temperature of the refrigerator and the temperature of the freezer compartment. To do this, press the **B** key and hold it for two seconds until the symbol for the desired compartment lights up: **B1** for the freezer compartment and **B2** for the refrigerator compartment.

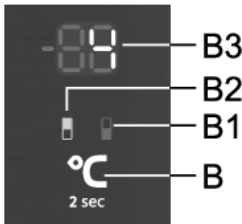

Temperature in the **refrigerator compartment** can be set when the **B2** symbol is lit. Set the temperature by briefly pressing the **B** key.

- Every time you press the key, the temperature will be increased by 1 °C. The setting you choose will be stored as the most recent temperature set for the refrigerator compartment.
- Refrigerator compartment temperature can be set in the range from +1 °C to +9 °C.
- Recommended temperature setting is 4°C.

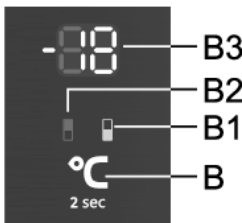

Temperature in the **freezer compartment** can be set when the **B1** symbol is lit. Set the temperature by briefly pressing the **B** key.

- Every time you press the **B** key, the temperature will be increased by 1 °C. The setting you choose will be stored as the most recent temperature set for the freezer compartment.
- Freezer compartment temperature can be set in the range from -16°C to -24°C.
- Recommended temperature setting is -18°C.



INFORMATION!

30 seconds after the most recent key is pressed, the freezer compartment display automatically switches back to refrigerator compartment display. **B2** will light up and the temperature set for the refrigerator compartment is displayed on the **B3** display unit.

Control unit/display standby mode



INFORMATION!

30 second after you have pressed the most recent key, the control unit switches to standby mode. All indicators on the control unit will be switched off. There are exceptions when some indicators remain lit although the control unit is in standby mode. Such exceptions include the following:

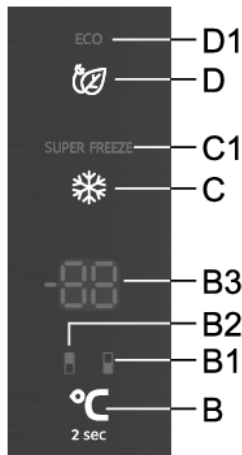

- If intensive freezing (freezer boost) is activated, then the indicator **C1** will remain lit. All other indicators are off.
- If the **Eco** function is activated, the indicator **D1** will still be displayed in standby mode. All other indicators are off.
- If the manual freezer compartment defrosting function is activated, then **CL** will still be displayed on the **B3** display unit, even when the control unit is in the standby mode. All other indicators are off.

To switch back from the standby mode: briefly press the **B** key or open the refrigerator compartment door. If the **Eco** function or the intensive freezing (freezer boost) function are activated, then the **C** or **D** key, respectively, may also be used to switch back from the control unit standby mode, depending on which function is activated.

Intensive freezing (freezer compartment)

- Use this setting after switching on the appliance for the first time, before cleaning, or before inserting a large amount of food.

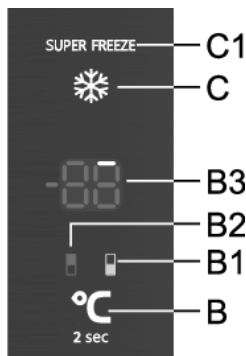

To activate the intensive freezing function, press the **C** key. You will hear a beep, indicators **B1** and **C1** will light up.

After 30 seconds, the display will automatically switch to the refrigerator compartment display – the symbol **B2** will light up and the temperature set for the refrigerator compartment will be displayed on the **B3** display unit.

If you use the **B** key during operation to select the freezer compartment (**B1** will light up), then you will see the outer segments of the two digits on the display unit gradually lighting up in a circular manner. At first, only the first segment (see figure above) will be lit; then, successive segment will light up in the clockwise direction.



Towards the end of this function's operation, all outer segments on the **B3** display unit will be lit up.

When the refrigerator compartment temperature is displayed – and the **B2** symbol is lit – briefly press the **C** key to switch to the freezer compartment display. The **B1** symbol will light up and the status of the function, or how many of the outer segments are already lit up, will be displayed on the **B3** display unit. After 30 seconds, the display will automatically switch back to refrigerator compartment temperature display, and the **B2** symbol will light up.

- Refrigerator compartment temperature can be set or adjusted while intensive freezing function is activated. You may do so when the **B2** symbol is lit up. Set the temperature by briefly pressing the **B** key. The intensive freezing function remains activated nevertheless.

Extreme freezing (upper drawer of the freezer compartment): This feature only works in the upper drawer of the freezer compartment. It relies on intensive supply/blowing of cool air. Faster freezing will retain more vitamins, minerals, and nutrients in the food for a longer period of time.



Switching off: If the refrigerator compartment is active (**B2** is lit up), then first press the **C** key to switch to the freezer compartment (**B1** will be lit up), and then press the **C** key to deactivate the function.

If the freezer compartment is activated (symbol **B1** is lit), then press the **C** key to deactivate the function.

- After the intensive freezing function is deactivated, the freezer temperature setting returns to the most recent setting selected before the intensive freezing function was activated.
- In case of a power supply failure or outage, the function will be reactivated.

INFORMATION!

- When the intensive freezing (fast freeze) function is activated, the appliance will operate with maximum power. During this time, operation may be temporarily somewhat louder.

INFORMATION!

- When the intensive freezing (super freeze) function is activated, temperature may be lower both in the refrigerator and the freezer compartment.

Eco function



Switching on: To activate the **Eco** function, briefly press the **D** key. The symbol **D1** will light up. When this function is activated, the appliance operates under optimum settings.

If the intensive freezing (super freeze) function or the manual freezer compartment defrosting function are activated, then the **Eco** function cannot be activated.

Switching off: To switch off the **Eco** function, again briefly press the **D** key. The temperature will return to the most recent setting.

The **Eco** function will also be deactivated when you use the **B** key to change the refrigerator compartment temperature setting, or when you use the **C** key to activate the intensive freezing function.

Child Lock

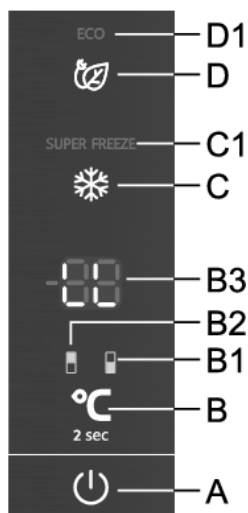

Switching on: To activate the child lock, press the **A** and **D** keys and hold it for two seconds. **LL** will briefly appear on the **B3** display unit.

The function will lock all keys except the **A** and **D** keys.

Switching off: To deactivate the function, press and hold the **A** and **D** keys again.

In case of a power supply failure or outage, the function will be reactivated.

High temperature alarm

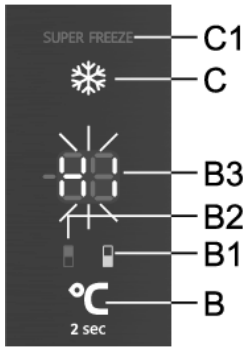

If the temperature inside the appliance is too high, then an acoustic alarm will be activated (intermittent tone). **HI** will flash on the **B3** display unit, and the symbol for the part of the appliance where the temperature is too high (**B1** or **B2**) will be lit.

- Every time the appliance is switched on with the **A** key, there is a 24-hour delay in high temperature alarm operation. If the appliance does not reach the sufficiently low temperature in this period, the alarm will be activated.

Switching off the alarm:

- Acknowledge and turn off the acoustic alarm by pressing any key. Current temperature in the compartment where the temperature is too high will start to flash on the **B3** display unit. If you do not acknowledge and switch off the acoustic alarm, then it will be activated every hour for approximately 15 minutes.
- The next time you press the **B** key, the temperature set for the compartment in which the temperature is currently too high will start to flash, and the symbol for the compartment where the temperature is too high will be lit (**B1** or **B2**). The temperature display will flash until the temperature drops to below the alarm value.
- When the temperature drops to below the alarm value, then the temperature display will stop flashing and it will be lit continuously. Refrigerator compartment temperature will be displayed and the **B2** symbol will light up.

Open door alarm

If the refrigerator or freezer compartment door is open for too long, an acoustic alarm (repetitive beep) will be activated. If the alarm is not deactivated manually, it will be sounded for 10 minutes.

The appliance will continue to operate as if the door was closed.

To switch off the alarm: to switch off the alarm, close the appliance door.



INFORMATION!

If you switch off the alarm by pressing any key, the alarm will be reactivated in 4 minutes if the door is still open.



INFORMATION!

If you leave the door open for more than 10 minutes, the alarm will no longer be sounded. Appliance operation will switch to safe mode in order to provide sufficient cooling and prevent food spoilage despite the open door.

Power outage/power supply failure alarm

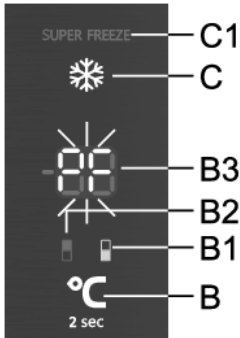

If the temperature in the appliance reached the alarm level during the power outage, then the high temperature alarm will be activated when power supply is restored. Acoustic alarm will be sounded, and **PF** will flash on the display unit **B3**.

To acknowledge and turn off the acoustic alarm signal, press any key. The highest measured temperature of the freezer compartment will be displayed on the **B3** display unit, and the **B1** symbol will light up.

The next time you press the **B** key, the highest measured temperature of the refrigerator compartment will be displayed, and the **B2** symbol will be lit up.

When you press the **B** key again, the power supply failure alarm will be finally deactivated, and the set temperature for the selected compartment will appear on the **B3** display unit.

If the high temperature alarm is activated at the same time, it will operate as described in the chapter High temperature alarm, after you have deactivated the power supply failure alarm.

Appliance interior equipment

(* Equipment depends on the model)

Shelf

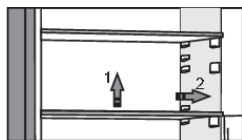

You can lay out the empty shelves to your liking across the guides in the refrigerator interior without having to remove them from the refrigerator. To move the shelf or take it out from the refrigerator, slightly lift it at the back, pull it towards you, and then either move it or take it out of the appliance. Store quickly perishable food at the back of the shelf where the temperature is the lowest.

Wire bottle rack *

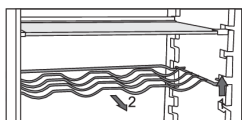

- Some models also feature a wire bottle holder. It is protected against being inadvertently pulled out. It can only be pulled out when it is empty. To pull it out, lift it slightly at the front and pull it towards you. Place the bottle holder so that the length of the bottles does not prevent proper closing of the door. The holder can take a maximum load of nine 0.75-litre bottles or 13 kilograms of total weight – see label on the right side in the appliance interior.
- Cans may also be placed on the bottle rack (lengthwise or crosswise).

Fruit and vegetable bin with humidity control (CrispZone) *

- The drawer at the bottom of the refrigerator is intended for storing fruit and vegetables. It provides humidity and prevents the food from drying out. The drawer has a humidity regulator which allows setting the humidity level.

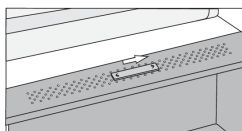

Slider position to the right: closed vents, higher humidity in the bin.

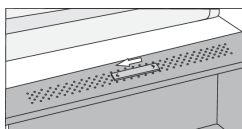

Slider position to the left: open vents, lower humidity in the bin.

If you observe droplets accumulating below the glass shelf, open the vents and wipe the shelf (see chapter TROUBLESHOOTING).

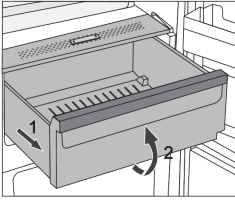

- Pulling out the bin:
 - Pull out the bin as far as it will go. Then, lift the front part and pull it out completely.

Fresh Box/Chill Zone drawer *

(Only in some models)

In the Fresh Box/Chill Zone compartment, food stays fresh longer than in a conventional refrigerator, retaining more flavour and nutrients.

Decay and loss of mass are slowed down; therefore, fruit and vegetables remain fresh and natural longer. For optimum performance, the drawer should be fully closed.

- When buying food, make sure it is fresh as this will determine the quality of the food, as well as how long it will keep in the fridge.
- Store the food in closed containers or appropriate packaging to prevent them from emitting or receiving odours and humidity.
- Take the food from the drawer 30 to 60 minutes before use to allow the aroma and flavour develop at room temperature.
- Food sensitive to low temperature and not appropriate for storage in the **Fresh Box/Chill Zone** drawer include the following: pineapple, avocado, bananas, olives, potatoes, eggplant, cucumbers, beans, peppers (capsicum), melons, watermelons, pumpkins, squash, zucchini etc.

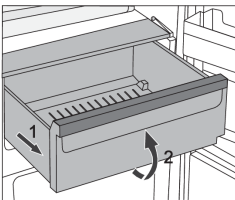

- To remove the drawer:
 - Pull out the drawer until it is blocked.
 - Lift it at the front and pull out completely.

Turning the Fresh Box/Chill Zone drawer into a fruit and vegetables drawer *

- If you find you need extra space for your fruit and vegetables, you can turn your **Fresh Box/Chill Zone** drawer into a fruit and vegetables drawer (CrispZone).
- To do this, use the slider as follows:
 - To use the drawer as a **Fresh Box/Chill Zone**: push the slider to the right.
 - To use the drawer as a **fruit and vegetables drawer (CrispZone)**: move the slider to the left.

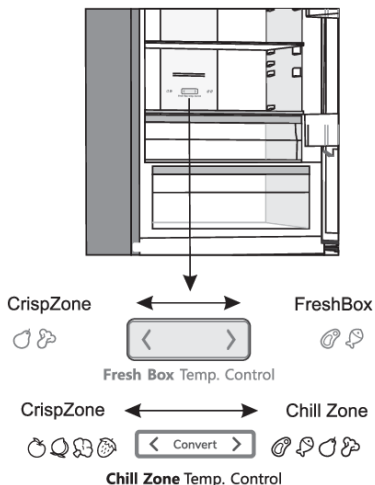

Door racks

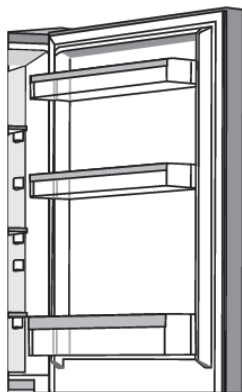

Interior side of the refrigerator door is fitted with shelves intended for storing cheese, butter, eggs, yoghurt, and other smaller packages, tubes, cans etc.

You may lay out the racks as desired by lifting them slightly from the grooves that hold them in place and moving them to the desired spot, making sure to fit them in the grooves there.

The bottom rack is intended for storing bottles.

Maximum load on each door shelf is 5 kg.

MultiFlow with air ionizer (NoFrost appliances) *

- The advanced MultiFlow fan system evenly distributes the ionized air and equalizes the temperature throughout the entire refrigerator. Air enriched with extra negative ions mimics the natural microclimate that keeps the food fresh for longer. This system also allows placing any type of food on any shelf in the fridge, as there are not temperature differences between them.

Smart Fresh

Innovative sensor technology allows adjusting appliance operation to the user's habits or behaviour. Adaptive intelligent system monitors, analyzes, and records on a daily and weekly basis the use of appliance and adapts appliance operation to the perceived patterns. If the appliance is able to anticipate increased frequency of door opening, the appliance will automatically lower the temperature before such time to prevent the increase of food temperature as the door is opened more often. The appliance will also anticipate adding larger amounts of food into the refrigerator or freezer and adapt by cooling or freezing more intensively.

Recommended distribution of food in the appliance

Sections in the refrigerator compartment:

- upper part: canned food, bread, wine, pastry ...
- middle part: dairy products, ready-made meals, desserts, soft drinks, beer, cooked food, etc.
- Fresh Box/Chill Zone bin: meat, meat produce, delicatessen,...
- Fruit and vegetable bin: fresh fruit, vegetables, salads, root vegetables, potatoes, onions, garlic, tomatoes, sauerkraut, turnips, etc.



Sections in the refrigerator compartment door:

- upper/middle door bins: eggs, butter, cheese, etc.
- lower door bins: beverages, cans, bottles, etc.



INFORMATION!

Do not store fruit (bananas, pineapples, papaya, citrus) and vegetables (zucchini, eggplant, cucumbers, bell peppers, tomatoes, and potatoes) sensitive to low temperatures in the refrigerator.

Freezer sections:

- freezing, storing frozen food (see chapter Freezing and storing frozen food).



INFORMATION!

Do not store the following in the freezer: lettuce, eggs, apples, pears, grapes, peaches, yoghurt, soured milk, sour cream, and mayonnaise.

Storing food in the refrigerator

Important warnings regarding food storage

INFORMATION!

Correct use of the appliance, appropriate packaging, maintaining the right temperature, and observing the food hygiene standards have a decisive impact on the quality of food storage.

Observe the expiry dates for the food, indicated on the packaging.

Food stored in the refrigerator should be kept in closed containers or in appropriate packaging to prevent it from emitting or receiving odours and humidity.

Do not store inflammable, volatile, and explosive substances in the refrigerator.

Bottles with high alcohol content should be tightly sealed and stored in an upright position.

Some organic solutions, essential oils in lemon and orange peel, butter acid, etc. may damage the plastic surfaces in case of a prolonged contact, causing damage and premature ageing of these materials.

Unpleasant odour warns of lacking cleanliness of the appliance or perished contents (see chapter Cleaning the Appliance).

If you are leaving home for a longer period of time, remove perishables from the refrigerator.

Avoid contamination of food

To avoid contamination of food, please respect the following instructions:

- Opening the door for long periods can cause a significant increase of the temperature in the compartments of the appliance.
- Regularly clean surfaces that can come in contact with food and accessible drainage systems.
- Store raw meat and fish in suitable containers in the refrigerator, so that it is not in contact with or drip onto other food.
- If the refrigerating appliance is left empty for long periods, switch off, defrost, clean, dry, and leave the door open to prevent mould developing within the appliance.

Freezing and storing frozen food

Freezing procedure

INFORMATION!

Maximum amount of fresh food that may be inserted at once is specified on the appliance rating plate. If the amount of food to be frozen exceeds the indicated amount, the quality of freezing will be inferior; in addition, the quality of the food already frozen will deteriorate.

- To make use of the entire freezer volume, remove all drawers.
- Activate the super freeze function 24 hours before freezing fresh food:
 - **control unit 1:** press and hold the **B** key until the light above the **D** symbol lights up.
 - **Control unit 2:** press key **D** until the symbol **D1** lights up;
 - **control unit 3:** press and hold the **C** key until the **C1** symbol starts to flash.

To make sure the food freezes as quickly as possible, lay out the packages as described below:

Divide fresh food into smaller packages (1 kg). Place two packages against the back wall along the left and right edge of the upper drawer, one package in the middle in front of them (also in the upper drawer), and one package in the middle drawer, against the middle of the back wall.

Make sure the fresh food is not in contact with the food that is already frozen.

- When freezing smaller amounts of food (1-2 kilograms), activating the super freeze function is not required.

Important warnings on freezing

INFORMATION!

Only use the freezer to freeze food appropriate for freezing. Always use quality and fresh food.

Select the most suitable packaging for the food and use the packaging correctly.

Make sure the packaging is air and water tight so that the food does not dry out and lose its vitamins.

Indicate the type of food, amount, and date of freezing on the packaging.

It is important that the food freezes quickly. Therefore, smaller packages are recommended. Refrigerate the food before freezing.

Storing industrially frozen food

- When storing and using frozen food, observe the manufacturer's instructions. Temperature and expiry date are indicated on the packaging.
- Only choose food with undamaged packaging, stored in freezers at temperatures of -18°C or lower.
- Do not purchase food covered in frost as this indicates it has been partly thawed several times and that it is of inferior quality.
- Protect the food from thawing during transport. In case of an increase in temperature, storage time will be shorter and quality will deteriorate.

Frozen food storage time

Recommended storage time in the freezer

Type of food	Storage life
Fruit, beef	from 10 to 12 months
Vegetables, veal, poultry	from 8 to 10 months
Venison	from 6 to 8 months
Pork	from 4 to 6 months
Finely chopped or minced meat	4 months
Bread, pastas, cooked dishes, whitefish	3 months
Offal	2 months
Smoked sausage, bluefish	1 month

Thawing frozen food

- Thawing is an important step in storing food preserved by freezing. Food must be thawed in the correct way.
- Suitable methods of thawing food are:
 - in the refrigerator;
 - in cold water;
 - in a microwave or conventional oven with a suitable thaw program.
- Some frozen products can be prepared without needing to thaw them first. The manufacturer will state this on the packaging.
- The food needs to be packed in small portions. In this way the food thaws faster.
- Use partially or completely thawed food as quickly as possible. The bacteria in thawed food are reactivated and the food will spoil rapidly. This applies in particular to fruit, vegetables and ready-made food.
- Do not refreeze partially or completely thawed food.

Defrosting the appliance

Automatic refrigerator defrosting

Refrigerator does not need defrosting because the ice on the back interior wall is thawed automatically. Any accumulated ice will melt when the compressor unit is inactive. Drops will flow through an opening in the refrigerator rear wall into a tray fitted above the compressor, from where they will evaporate.

Make sure the opening in the back wall in the refrigerator interior is never blocked by food or any other object.

If an excessive layer of ice is formed on the rear wall of refrigerator interior (3–5 mm), switch off the appliance and defrost the appliance manually.

Defrosting a NoFrost freezer

- The NoFrost freezer will defrost automatically. Any frost layer that may build up occasionally will disappear automatically.

Manual defrosting of the NoFrost freezer

- A layer of frost could build up on the appliance walls despite the NoFrost feature. This is usually a result of abnormal use of the appliance, such as too frequent door opening, leaving the door open for too long, poor door seal etc.

In such case, the freezer can be defrosted manually, according to the following procedure:

Control unit 1

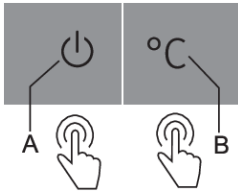

- Simultaneously press the **A** and **B** keys and hold them (10 seconds).
- When the defrosting process is completed, the function will be deactivated automatically.

Control unit 3

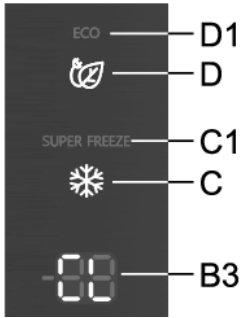

- Simultaneously press the **D** and **C** keys and hold them. At first, the outer segments of the two digits on the **B3** display unit will light up in a circular manner; then, CL will appear on the display unit.
- When the defrosting process is completed, the function will be deactivated automatically. The temperature set for the refrigerator compartment will be displayed on the **B3** display unit.

Cleaning the appliance



WARNING!

Before cleaning, unplug the appliance from the power mains – switch off the appliance (see chapter Switching the Appliance On/Off) and unplug the power cord from the wall outlet.

- Use a soft cloth to clean all surfaces. Cleaners that contain abrasive substances, acids, or solvents are not suitable for cleaning as they may damage the surface.

Clean the appliance exterior with water or a mild solution of suds.

Lacquer-coated and aluminium surfaces may be cleaned with lukewarm water to which you have added a mild detergent. Use of cleaners with low alcohol content is allowed (e.g. window cleaners). Do not use cleaners containing alcohol for cleaning plastic materials.

Appliance interior can be cleaned with lukewarm water to which you can add some vinegar.

- Do not wash the parts of appliance interior equipment in a dishwasher as they may be damaged.

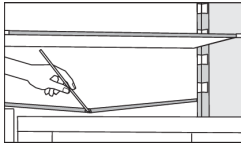

- A gutter and an opening for discharging the water from thawed frost deposits are located underneath the cooling panel that cools the refrigerator interior. The gutter and the opening may not be clogged. Inspect them often and clean if necessary (e.g. with a plastic straw).

- Frost or ice build-up, 3–5 mm thick, will increase power consumption. Therefore, it should be regularly removed (does not apply to NO FROST freezers). Do not use any sharp objects, solvents, or sprays.
- The condenser unit, located next to the compressor unit on the back of the appliance (only with some models), has to be kept clean, free of dust or other impurities. Occasionally clean it using a soft non-metal brush or a vacuum cleaner.
- After cleaning, switch the appliance back on and insert the food.

Troubleshooting

Problem:	Cause or remedy:
Appliance is connected to the power mains but it does not work.	<ul style="list-style-type: none"> • Make sure there is voltage in the power outlet and that the appliance is switched on.
Cooling system operates continuously for a long period of time: 	<ul style="list-style-type: none"> • Too high environment temperature. • Door opened too frequently or too long. • Door not closed correctly (possible impurities on the seal, misaligned door, damaged seal etc.). • Too much fresh food inserted at once. • Sensor in the refrigerator (A) blocked by fresh food. Make sure the air can circulate around the sensor (only with some models).
Excessive build-up of ice on the back wall of refrigerator interior can be a result of the following:	<ul style="list-style-type: none"> • door opened too frequently or too long. • Warm food placed in the refrigerator. • Food or containers in contact with the back interior wall of the refrigerator. • Poor door sealing. • If the seal is dirty or damaged, clean or replace it.
Build-up of ice or frost in the freezer interior:	<ul style="list-style-type: none"> • The door has been opened for too long or too frequently. • The door is not properly closed. • The door has a poor seal (the gasket is dirty, the door is not properly aligned, the gasket is damaged etc.). • Manually defrost the appliance.
Condensate (dew) on the shelf above the drawers:	<ul style="list-style-type: none"> • This is transient phenomenon which cannot be entirely avoided in periods of high environment temperature and humidity. It subsides when temperature and humidity are normalized. We recommend cleaning the drawers more frequently and wiping the droplets occasionally. • Open the humidity control slider. • Put food in bags or other packaging with a good seal.
Droplets on the refrigerator compartment back wall.	<ul style="list-style-type: none"> • This is normal. The refrigerator compartment is defrosted automatically, which results in droplets of water that flows through an opening in the refrigerator compartment back wall into a tray above the compressor unit, from which it evaporates.
Water is dripping/leaking from the refrigerator:	<ul style="list-style-type: none"> • Clogged water discharge opening or water dripping past the water gutter. • Clean the blocked opening, e.g. using a plastic straw. • If a thick layer of ice builds up, defrost the appliance manually (see Defrosting the Appliance).

Table continued from last page

Problem:	Cause or remedy:
The light above the set temperature display will flash (control unit 1).	<ul style="list-style-type: none"> • Door opened too frequently or too long. • Door not closed correctly (possible impurities on the seal, misaligned door, damaged seal etc.). • An extended power failure. • Too much fresh food inserted at once.
Door is difficult to open:	<ul style="list-style-type: none"> • If you are trying to open the freezer door after just having closed it, this could be difficult to do. As you open the door, some cool air escapes from the appliance and it is replaced by warm air from the environment. When this air is cooled, negative pressure is generated which results in problems as you try to open the door. After a few minutes, the condition is normalized and the door can be easily opened again.
Appliance sides are warm:	<ul style="list-style-type: none"> • This is normal. There are pipes and tubes installed in the appliance sides, which tend to heat up during appliance operation.
LED lighting does not work:	<ul style="list-style-type: none"> • If LED lighting does not work, call a service technician. • Do not attempt a repair of the LED lighting yourself, as there is danger of contact with high voltage!
Signal light above the 2, 3 or 5 indicator flashes (control unit 1):	<ul style="list-style-type: none"> • Temperature sensor error or fault. Call a service centre for repair. Until the appliance is repaired by a service technician, the appliance will operate in safe mode. The appliance will automatically preserve the most suitable temperature for each compartment.
Signal light above the D or E indicator flashes (control unit 1):	<ul style="list-style-type: none"> • Sensor keys are not responding. Call a service centre for repair. • Until the appliance is repaired by a service technician, the appliance will operate in safe mode. The appliance will automatically preserve the most suitable temperature for each compartment.
Signal light above the 8 indicator flashes (control unit 1):	<ul style="list-style-type: none"> • Door was open for too long. Close the door. • If the lighting in the compartment does not function either, then there is a door sensor fault. Call a service centre to arrange a repair. The appliance will operate in safe mode until it is repaired. The appliance will automatically preserve the most suitable temperature for each compartment.
HI will appear on the display unit (control unit 3).	<ul style="list-style-type: none"> • Door opened too frequently or too long. • Door not closed correctly (possible impurities on the seal, misaligned door, damaged seal etc.). • An extended power failure. • Too much fresh food inserted at once.

Table continued from last page

Problem:	Cause or remedy:
PF will appear on the display unit (control unit 3).	<ul style="list-style-type: none"> • An extended power failure.
E0 will appear on the display unit (control unit 3).	<ul style="list-style-type: none"> • Sensor keys are not responding. Call a service centre for repair. • Until the appliance is repaired by a service technician, the appliance will operate in safe mode. The appliance will automatically preserve the most suitable temperature for each compartment.
E1 or E2 will appear on the display unit (control unit 3).	<ul style="list-style-type: none"> • Temperature sensor error or fault. Call a service centre for repair. Until the appliance is repaired by a service technician, the appliance will operate in safe mode. The appliance will automatically preserve the most suitable temperature for each compartment.
E9 will appear on the display unit (control unit 3).	<ul style="list-style-type: none"> • Door was open for too long. Close the door. • If the lighting in the compartment does not function either, then there is a door sensor fault. Call a service centre to arrange a repair. The appliance will operate in safe mode until it is repaired. The appliance will automatically preserve the most suitable temperature for each compartment.

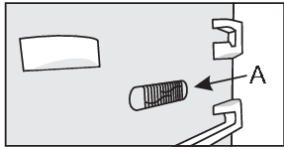
If the above tips do not resolve your problem, call the nearest authorized service centre and state the type, model, and serial number indicated on the appliance rating plate or label located in the appliance interior.

Information about appliance noise

Cooling in refrigerator freezers is made possible by a cooling system that also includes a compressor (and a fan with some appliances), which generates some noise. The level of noise depends on installation, proper use, and age of the appliance.

- After connecting the appliance to the power mains, compressor operation, or the sound of flowing liquid, may be somewhat louder. This is not a sign of malfunction and it will not affect the useful life of the appliance. In time, appliance operation and this noise will become quieter.
- Sometimes, unusual or loud noises may appear during appliance operation; these are mostly the result of improper installation:
 - The appliance must stand level and stable on a solid base.
 - The appliance may not be in contact with a wall or adjacent furniture.
 - Make sure the interior equipment sits firmly in its place and that the noise is not caused by rattling cans, bottles or other containers placed next to each other.
- Due to the higher workload on the cooling system when the door is opened more frequently or for a longer time, when a large amount of fresh food is introduced or when intensive freezing or cooling functions are activated, the appliance can temporarily generate more noise.

Environment protection

Packaging is made of environmentally friendly materials that can be recycled, disposed of, or destroyed without any hazard to the environment.

Removing an obsolete appliance

To protect the environment, take the obsolete appliance to an authorized home appliance collection centre.

Before doing so, do the following:

- disconnect the appliance from the power mains;
- do not allow children to play with the appliance.



■ The symbol on the product or its packaging indicates that the product should not be treated as normal household waste. The product should be taken to an authorized collection centre for waste electric and electronic equipment processing. Correct disposal of the product will help prevent any negative effects on the environment and health of people which could occur in case of incorrect product removal. For detailed information on removal and processing of the product, please contact the relevant municipal body in charge of waste management, your waste disposal service, or the store where you bought the product.

Your notes

Hisense UK Ltd

Ground floor, Munroe Court, White Rose Office Park,
Millshaw Park Lane, Leeds LS11 0EA

Hisense France SAS

Bâtiment Front Office 12 à 16 rue Sarah Bernhardt
92600 ASNIERES-SUR-SEINE

Hisense Gorenje Germany GmbH

Parkring 31-33, 85748 Garching b. München, Deutschland

Hisense Italia SRL

Via Montefeltro, 6/A 20156 Milano, Italia

Hisense Iberia SLU

C/ Botiguers, nº 5, Edificio B, 2ª planta
(46988) Paterna (Valencia-Spain)

GORENJE GOSPODINJSKI APARATI, d.o.o.

Partizanska cesta 12, SI-3320 Velenje, Slovenia

Hisense



818898-a3

