

EN

DETAILED INSTRUCTIONS

HOW TO USE YOUR WASHING MACHINE

Pelgrim

PWM120WIT
PWM121WIT

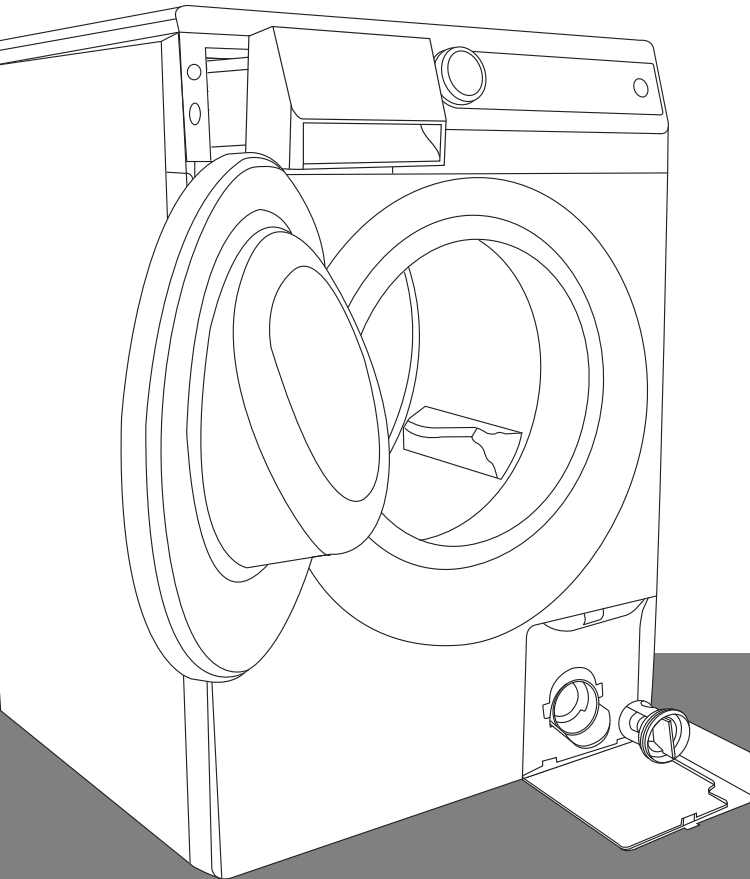

www.pelgrim.com

We thank you for your trust and the purchase of our washing machine.

Your new washing machine complies with the requirements of modern laundry care. Your laundry will be impeccably white even at low temperatures, owing to special washing programs like **Ultra White**.

SensoCare technology allows simple control of the washing machine.

Your washing machine is highly economical when it comes to use of power, water, and detergent.

The washing machine is intended exclusively for use in households, for washing the laundry that is indicated as machine washable.

TABLE OF CONTENTS

4 WASHING MACHINE 5 Technical information 6 Front panel	INTRODUCTION
8 SAFETY PRECAUTIONS	
10 INSTALLATION AND CONNECTION 10 Removal of transport brackets 11 Selecting the room 11 Installation 13 Water inlet connection 14 Aqua-stop 14 Total aqua - stop 15 Water outlet connection 16 Connect the appliance to the mains supply 17 Moving and transport 17 Subsequent transport	PREPARING THE APPLIANCE FOR THE FIRST USE
18 BEFORE THE USE	
19 WASHING STEPS (1 - 7) 19 1. Step: check the tags on your laundry 20 2. Step: preparing the washing process 22 3. Step: choosing a programme 25 4. Step: choosing the settings 27 5. Step: selecting additional functions 29 6. Step: program start 29 7. Step: end of washing program	STEPS OF THE WASHING PROCESS
30 LEANING AND MAINTENANCE 30 Cleaning the detergent dispenser 31 Cleaning the dispenser housing, inlet hose screen and door rubber gasket 32 Cleaning the filter 33 Cleaning the washing machine	CLEANING & MAINTENANCE OF THE APPLIANCE
34 INTERRUPTING AND CHANGING THE PROGRAM 35 What to do ...? 36 Troubleshooting table	TROUBLE-SHOOTING
38 RECOMMENDATIONS FOR WASHING AND ECONOMIC USE YOUR WASHING MACHINE 40 Grandma's advice for natural stain removal 42 DISPOSAL 43 TYPICAL CONSUMPTION TABLE	OTHER

WASHING MACHINE

(WASHING MACHINE DESCRIPTION)

FRONT

- 1 Front panel
- 2 Dispenser
- 3 Door
- 4 Filter

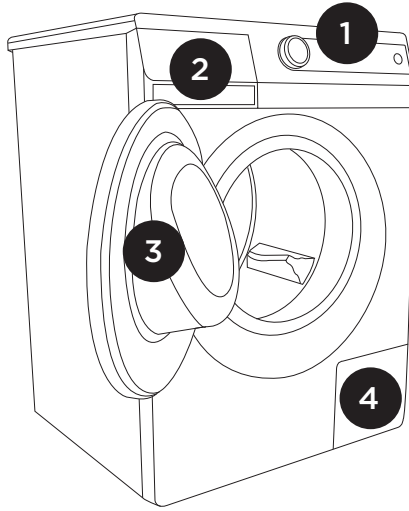

BACK

- 1 Water inlet pipe
- 2 Power cord
- 3 Water discharge pipe
- 4 Adjustable feet

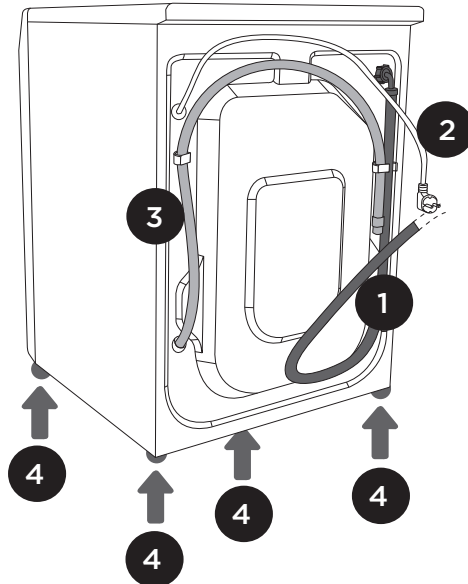

TECHNICAL INFORMATION







(DEPENDING ON THE MODEL)

The rating plate with the basic information on the washing machine is located under the washing machine door.

Maximum load	See rating plate	See rating plate (SLIM)
Width	600 mm	600 mm
Height	850 mm	850 mm
Depth	600 mm	440 mm
Depth with door open	108 cm	92 cm
Washing machine weight	x kg (depending on the model)	x kg (depending on the model)
Rated Voltage	See rating plate	See rating plate
Nominal power	See rating plate	See rating plate
Connection	See rating plate	See rating plate
Water pressure	See rating plate	See rating plate
Current	See rating plate	See rating plate
Frequency	See rating plate	See rating plate

Rating plate



TYPE: PS10/XXX	MODEL: XXXXXX	
Art.No.: XXXXXX	Ser.No.: XXXXXX	
AC 220-240V 50/60 Hz	 10A	Pmax.: 2400W
 2000W	 XXX/min	 0,05-0,8 MPa
IPX4	MADE IN EU	

FRONT PANEL

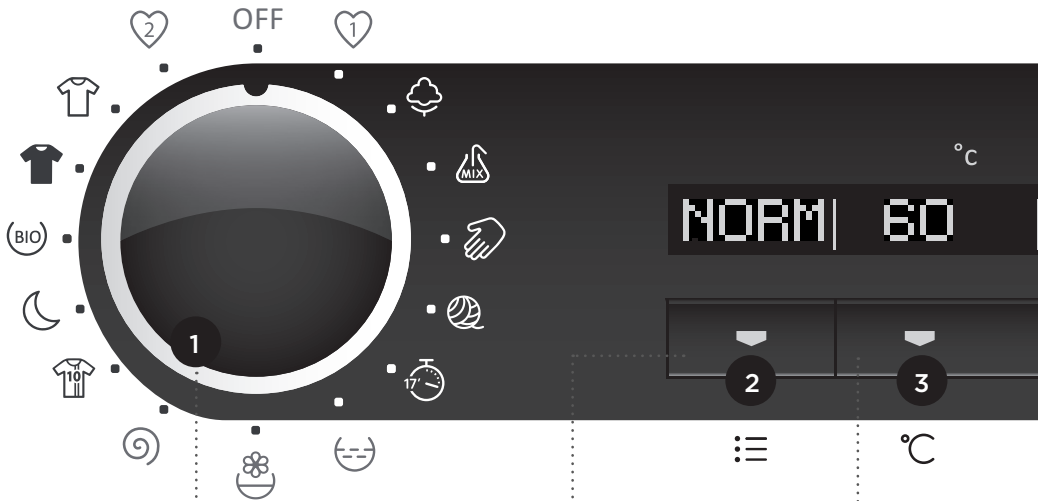

1 Washing machine ON/
OFF and program
SELECTOR DIAL

2 WASHING STYLE key
(SensoCare)

NORMALcare

NORM

ECOcare

ECO

ALLERGYcare

ALRG

TIMEcare

TIME

Washing style will appear on
the display above the key.

3 WASHING
TEMPERATURE key

Washing temperature will
appear on the display above
the key.



START | PAUSE

4 SPINNING RPM / PUMP (DRAIN)/ STOP PUMP (RH) key

SPINNING RPM /
PUMP (DRAIN) /
PUMP STOP (RH)

will appear on the display
above the key.

6 a, b, c ADDITIONAL FUNCTION keys

6a Prewash
6b Extra water
6c SterilTub

7 START/PAUSE key

Use this key to start or
stop the program.

When the machine is turned
on, the signal light on the
key starts to flash; when the
program is started, it is lit
continuously.

5 WASHING PROGRAM COMPLETION TIME (END TIME) key

WASHING TIME
COMPLETION

will appear on the display
above the key.

SAFETY PRECAUTIONS



Please, do not use the washing machine without reading and understanding these instructions or use first.

Be sure to remove transport brackets **prior first use of the appliance**. Attempted operation of the blocked machine may result in irreparable damage which is not covered by the manufacturer's warranty!

When connecting your washing machine to water supply, be sure to use the supplied water inlet hose and sealing gaskets.

Failure to observe the instructions for use or inappropriate use of the washing machine may result in damage to the laundry or machine, or injury to the user. Keep the instructions for use handy, near the washing machine.

Do not install the machine in a room where temperature can drop below 0°C. Parts of the machine may be damaged if the water inside them freezes.

Install the washing machine in a perfectly horizontal position, on solid flat (concrete) floor.

Follow the instructions for correct installation and water and mains connections (see chapter "Installation and connections").

Never immerse the end of the drain hose into the draining water.

Prior starting the washing cycle lock the **door** by pressing them at the designed spot.

Door may not be open during the washing cycle.

We recommend running the self-cleaning program before the first wash in order to remove any impurities from the washing machine drum. (See chapter on "Selecting additional functions".

Use only detergents and softeners for machine wash. Manufacturer may not assume responsibility for any damage and eventual discolouring of gaskets and plastic components as a consequence of incorrect use of bleach and/or colouring agents.

For removal of lime residues use such agents with added anti-corrosion agents. Follow the manufacturer's instructions. Finish the lime removal by multiple rinsing to remove completely eventual acid residues (e.g. vinegar etc.).

Never use detergents containing solvents, since there is a danger of creating toxic gasses which may damage the machine and result in ignition or explosion.

This product does not release silver ions during the washing cycle.

Upon completion of the washing cycle, close the water faucet and unplug the mains cord.

Before transporting the machine after it has been used, block the drum by inserting at least one transport blocking rod. Disconnect the appliance from the mains power before inserting the rod!

Rating plate with basic information is located above the opening of the machine.

Leave any repairs and similar tasks on the washing machine to an expert. Unprofessional repair may result in an accident or major malfunction.

The warranty shall not apply to consumables, minor discoloration or deviations of colour, increased noise level as a consequence of appliance age, which does not affect appliance functionality, and aesthetical deficiencies which do not affect appliance functionality or safety.

The appliance is intended exclusively for use in households. If the appliance is used for professional purposes, for profit, or for purposes beyond regular use in a household, or if appliance is used by a person who is not a consumer, the warranty period equals the shortest warranty period possible as stipulated by the relevant legislation.

THE APPLIANCE IS MANUFACTURED IN COMPLIANCE WITH ALL RELEVANT SAFETY STANDARDS.

THIS APPLIANCE CAN BE USED BY CHILDREN AGED FROM 8 YEARS AND ABOVE AND PERSONS WITH REDUCED PHYSICAL, SENSORY OR MENTAL CAPABILITIES OR LACK OF EXPERIENCE AND KNOWLEDGE IF THEY HAVE BEEN GIVEN SUPERVISION OR INSTRUCTION CONCERNING USE OF THE APPLIANCE IN A SAFE WAY AND UNDERSTAND THE HAZARDS INVOLVED. CHILDREN SHALL NOT PLAY WITH THE APPLIANCE. CLEANING AND USER MAINTENANCE SHALL NOT BE MADE BY CHILDREN WITHOUT SUPERVISION.

BEFORE CONNECTING THE WASHING MACHINE:



Carefully read the instructions for use before connecting the washing machine. Repair or any warranty claim resulting from incorrect connection or use of the washing machine shall not be covered by the warranty.

INSTALLATION AND CONNECTION

REMOVAL OF TRANSPORT BRACKETS

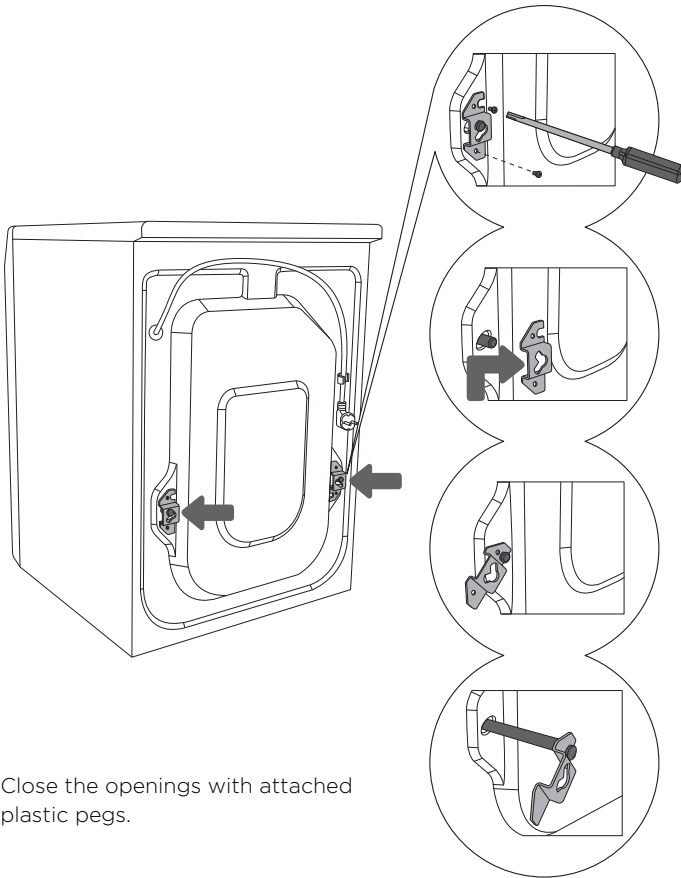

Close the openings with attached plastic pegs.

1 Move the pipes. Loosen screws at the rear of the machine.

2 Remove the brackets.

3 Slide brackets into the groove on the blocking rod - the right one should be turned around.

4 Use the brackets to rotate blocking rods for 90° and pull them out.



Be careful to prevent personal injury.

In removing the wrapping be careful not to damage the appliance with a sharp object.

Remove transport protection devices; as running the washing machine with the blocking rods in place could result in damage. Save transport brackets for eventual later use.

Warranty shall be void in cases of such damage.

SELECTING THE ROOM



The appliance should be placed on a surface with concrete base; the surface should be dry and clean in order to prevent slipping. The adjustable feet should also be cleaned before installation.

INSTALLATION

Use a water scale and spanner No. 22 (for feet) and 17 (for the nut).

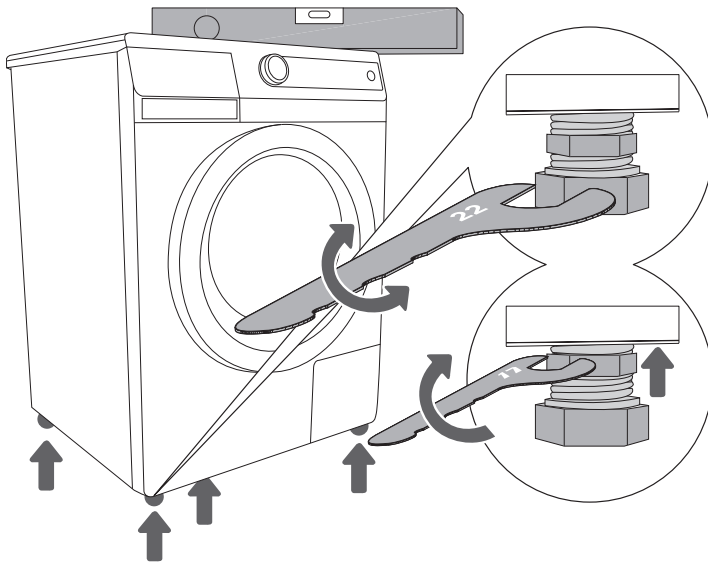

.....
1 Put the appliance in horizontal position by turning the adjustable legs. The legs are adjustable up to +/- 1 cm.
.....

2 After the adjustment tighten the nuts firmly - towards the bottom of the machine!



Vibrations, moving of the appliance and loud operation due to incorrect setting of the adjustable feet shall not be covered by this warranty.

If you have a tumble dryer of the same dimensions, you can place it on top of the washing machine by using the vacuum feet or side by side.

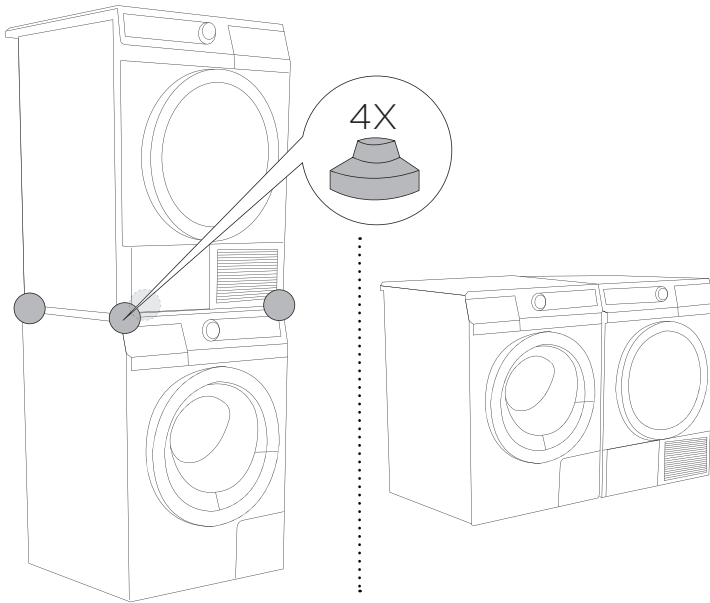

Before connecting the appliance, let it warm up to room temperature (wait at least two hours).

WATER INLET CONNECTION

Insert the gasket with a filter net into the straight inlet hose attachment nut and screw the nut onto the water tap (with some models, the gasket with filter net is already fitted and any additional fitting into the nut on the straight attachment is not required).

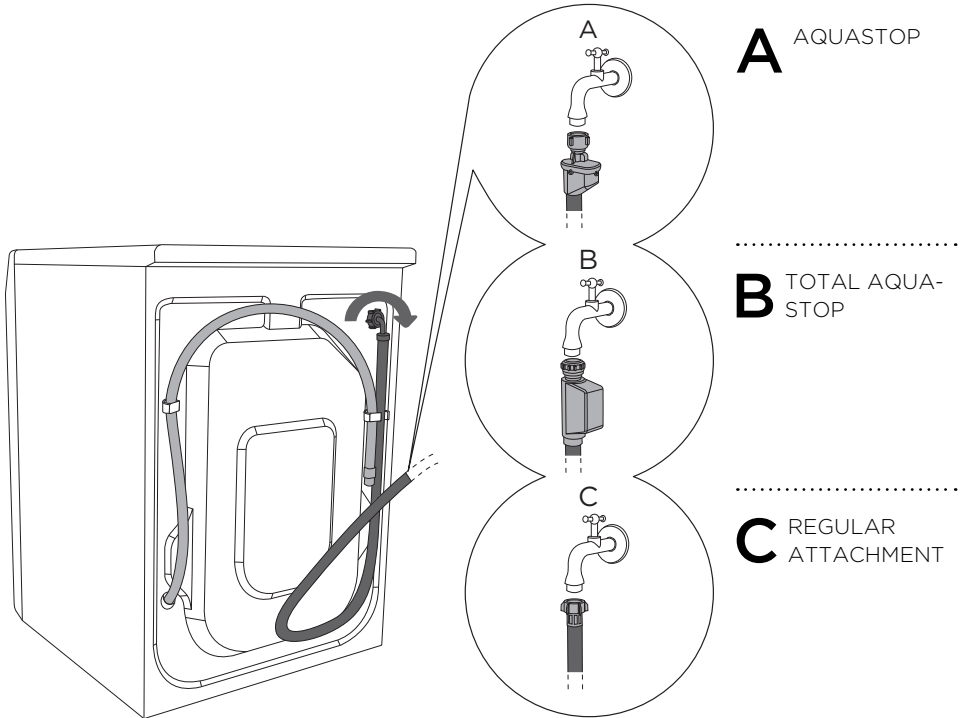

To ensure correct operation of the appliance, water pressure inlet must be between 0,05 and 0,8 MPa. Minimum water pressure can be established by measuring the quantity of poured out water. 3 litres of water must be poured out from completely opened tap in 15 seconds.

If your model has connections for both hot and cold water, then connect one hose to the cold water supply (blue wing nut or blue mark on the hose) and the other one to the hot water supply (red wing nut or red mark on the hose), as indicated on the back wall of the appliance (letters C and H) (C - cold; H - hot).

The inlet hose should be tightened manually, firmly enough to prevent any leaks. After tightening the hose, check for any leaks. Use of pliers, wrenches, or other similar tools is not allowed when installing the hose, as these tools can damage the nut thread.

AQUA-STOP (CERTAIN MODELS ONLY)

In case of damage on the interior pipe, leaking is prevented by automatic closing system which stops water inlet to the machine. In such cases display (A) turns red. Inlet pipe must be replaced.

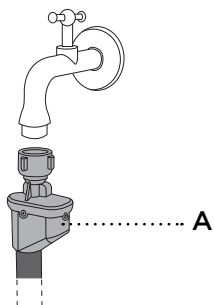

TOTAL AQUA - STOP (CERTAIN MODELS ONLY)

In case of damage on the interior pipe, leaking is prevented by automatic closing system which stops water inlet to the machine. Protection system will also detect whether there is any water leakage in the washing machine interior. In such cases, washing is suspended, water supply is cut off, and machine switches on the pump and signals an error.

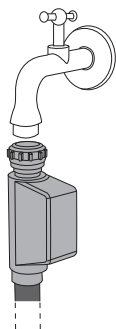

Do not immerse the Aqua-stop system inlet pipe into the water, because it contains the electric valve!

WATER OUTLET CONNECTION

Fix the drain hose to run into the sink or the bathtub, or connect it directly to the wall drain outlet (diameter min. 4 cm). The end of outlet hose should be placed between minimum 60 cm and maximum 100 cm above the floor level. It can be attached in three ways (A, B, C).

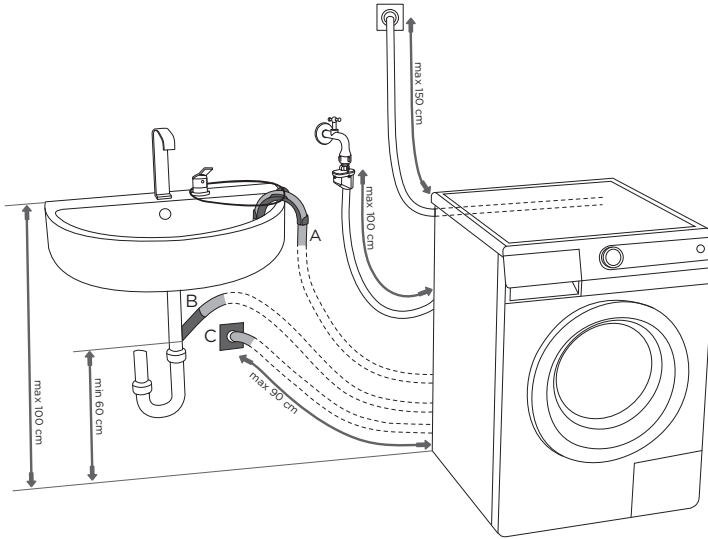

A Outlet hose can be led into a wash basin or a bathtub. Use a string to attach the hose to the opening in the elbow support to prevent it from slipping to the floor.

B Drain hose can also be attached directly to the basin drain.

C Drain hose can also be connected to a wall drain with a trap that is properly installed to allow cleaning.

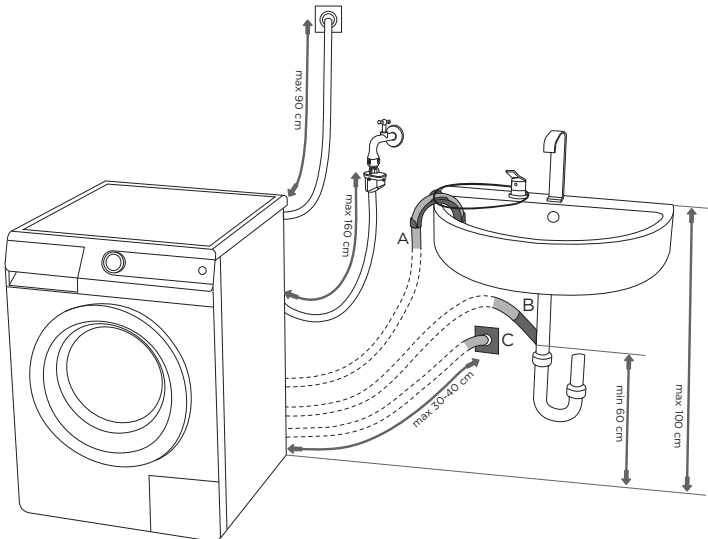

CONNECT THE APPLIANCE TO THE MAINS SUPPLY

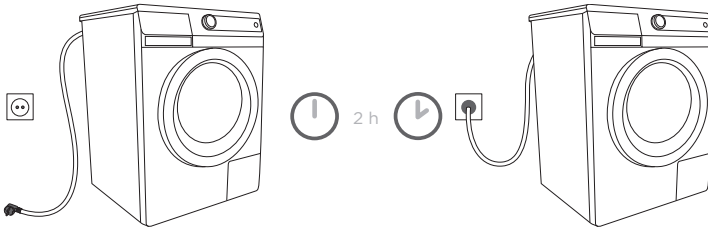

After it is installed for the first time, the washing machine should be left to stand still for two hours before it is connected to the power mains.

Use the power cord to connect the washing machine to the power mains through a power outlet. The washing machine may not be connected to the power mains through an extension cable (danger of overheating and fire). Nominal voltage and other information is given on the rating plate located under the door frame.

To prevent from damage by excess voltage on the mains due to lightning strike we recommend to use a class I over-voltage protector between the machine and the mains.



The wall socket must be accessible at all times and must be equipped with an earth lead (in accordance with the local safety regulations).

The permanent connection must be fitted by an authorized personnel only.

To avoid hazard, damaged power cord may only be replaced by the manufacturer, authorized service technician, or other authorized person.

Never plug the appliance into the electric shaver socket or hair dryer socket.

MOVING AND TRANSPORT



After transport, the washing machine should be left to stand still for at least two hours before it is connected to the power mains.

We recommend that installation and connection should be done by a qualified person.

Before connecting the appliance, read the instructions for use. Repair or any warranty claim resulting from incorrect connection or use of the appliance shall not be covered by the warranty.

SUBSEQUENT TRANSPORT

Before transporting the washing machine, insert at least one blocking rod (transport protection) in order to avoid damage to the washing machine.

BEFORE THE USE

Open the door of the unplugged washing machine by pulling the lever towards you.

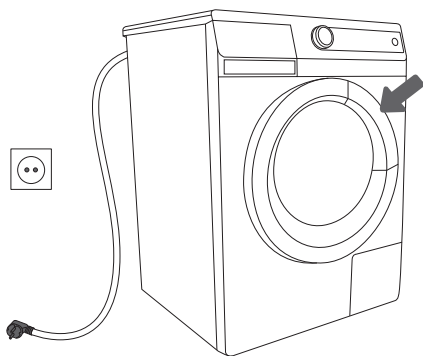

1

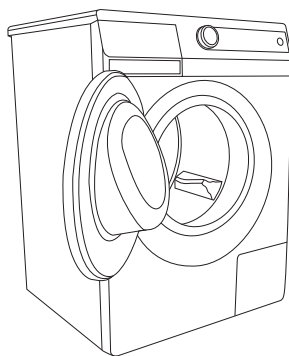

2

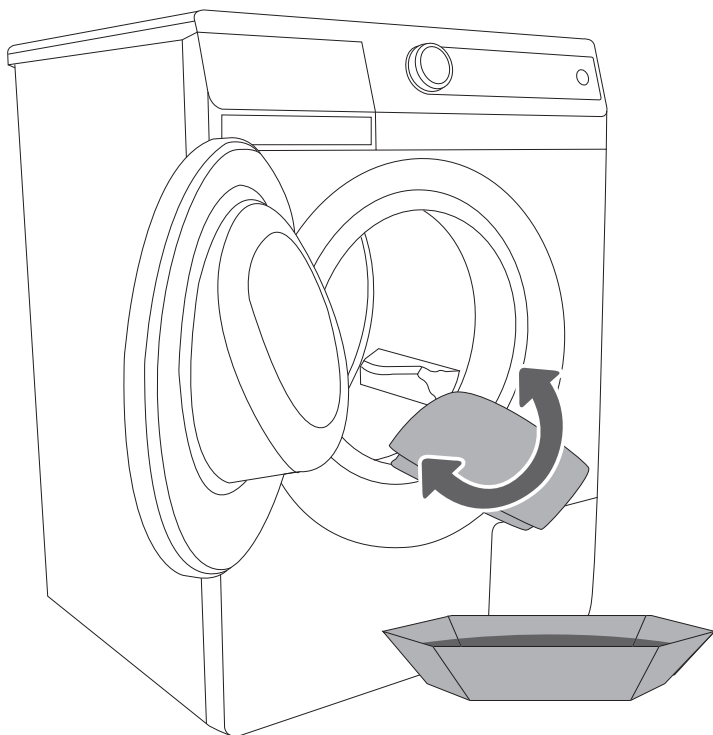



























.....

Clean the washing machine drum before using the appliance for the first time. Use a damp cloth and a mild cleaning agent, or run the self-cleaning program.

WASHING STEPS (1 - 7)

1. STEP: CHECK THE TAGS ON YOUR LAUNDRY

Normal wash Delicate wash	Max. washing 95°C  	Max. washing 60°C  	Max. washing 40°C  	Max. washing 30°C  	Manual washing 	Washing not allowed 
Whitening	Whitening in cold water 			Whitening not allowed 		
Dry cleaning	Dry cleaning in all solvents 	Perchloret-ylene R11, R113, Petrolej 	Dry cleaning in kerosene, in pure alcohol and in R 113 	Dry cleaning not allowed 		
Ironing	Hot iron max. 200°C 	Hot iron max. 150°C 	Hot iron max. 110°C 	Ironing not allowed 		
Drying	Place on flat surface 	Hang wet  Hang 	High temp.  Low temp. 	Tumble drying not allowed 		

2. STEP: PREPARING THE WASHING PROCESS

1. Sort the laundry by type of fabric, colour, soiling, and allowed washing temperature (see Program table).
2. Close the buttons and zippers, tie any ribbons, and turn the pockets inside-out; remove any metal clips that could damage the laundry and washing machine interior, or clog the drain.
3. Very delicate laundry should be put in a special protective sack.

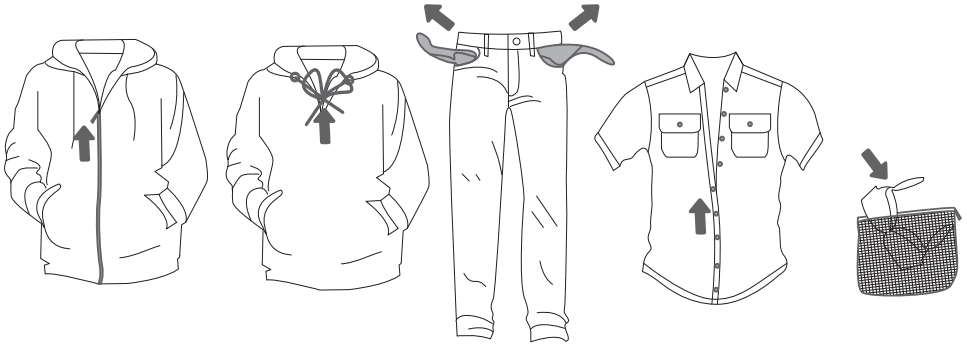

SWITCHING ON THE WASHING MACHINE

Connect the washing machine to the power mains using the power cord, and connect it to water supply.

To light up the drum (certain models only), rotate the program selector dial to any position.

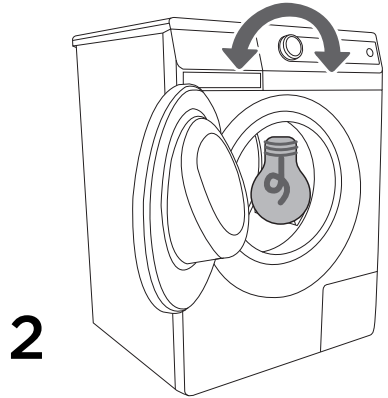
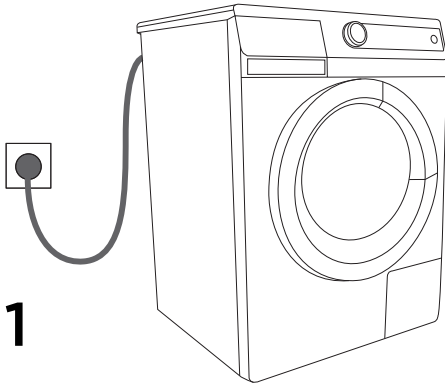

LOADING THE WASHING MACHINE

Open the door of the washing machine by pulling the lever towards you.

Load the laundry into the drum (check that the drum is empty).

Close the door of the washing machine.

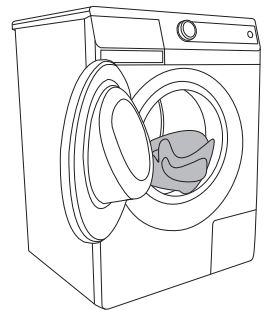
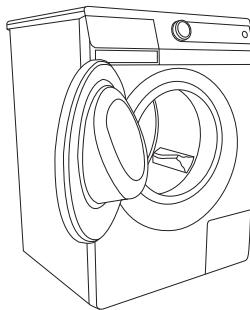
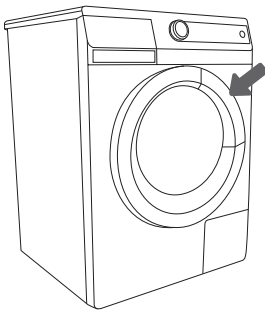

3. STEP: CHOOSING A PROGRAMME



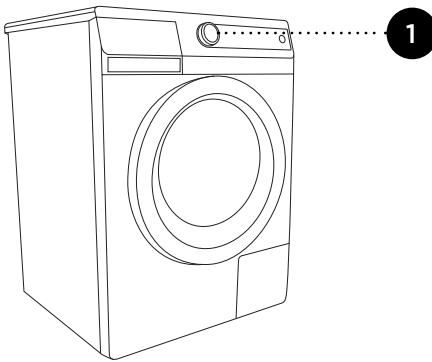
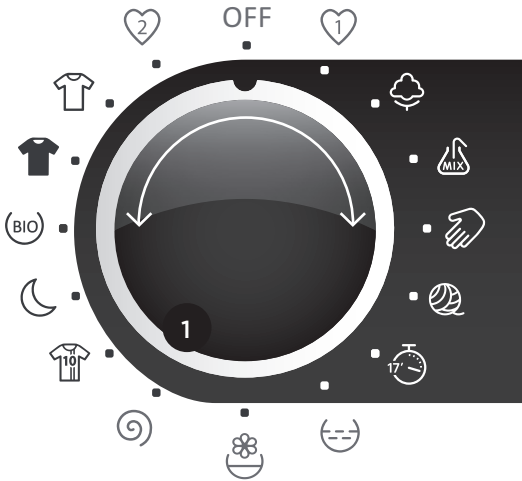





To select a **program**, rotate the program selector dial to the left or to the right (according to the type or how soiled the laundry is). See Program Table.







During operation, the dial will not rotate automatically.

Washing programs are entire programs that include all washing stages, including conditioning and spinning.

PROGRAM TABLE

Program:	Max. load	Type of laundry	Possible combinations
 Cotton	9 kg/ 8 kg/ 7 kg 6 kg"	Non-sensitive cotton and linen laundry (towels, underwear, T-shirts, terry towelling and underwear, stockinette, tablecloths, kitchen cloths etc.).	<ul style="list-style-type: none"> • spinning • pump stop (RH) • normal • eco care** • time care • prewash* • anti-allergic* • extra water (*except for at 15°C, 🌀) (**except for at 🌀)
 Mix/Synthetics	3,5 kg/ 3,5 kg/ 3 kg 3 kg"	Coloured laundry (of like colours) made of durable mixed fabrics (trousers, T-shirts, dresses etc.) and other clothing made of polyester, polyamide, or mixes of these fibres with cotton (shirts, blouses, etc.).	<ul style="list-style-type: none"> • spinning • pump stop (RH) • normal • eco care** • time care • prewash** • anti-allergic* • extra water (*except for at 30°C, 🌀) (**except for at 🌀)
 Hand Wash/Delicate	2,5 kg/ 2,5 kg/ 2,5 kg 1,5 kg"	Delicate laundry made of linen, silk, wool, or viscose silk, labelled for hand wash only (dresses, skirts, blouses etc.) and curtains. Very gentle program that preserves the fabric of your clothes.	<ul style="list-style-type: none"> • spinning • pump stop (RH) • normal • time care • extra water • prewash* (*except for at 🌀)
 Wool	2 kg/ 2 kg/ 2 kg 1 kg"	Woollen garments and woollen mixtures (sweaters, scarves, head scarves etc.), labelled for machine washing.	<ul style="list-style-type: none"> • spinning • pump stop (RH) • normal • time care • extra water
 Quick Wash 17'	2 kg/ 2 kg/ 2 kg 1,5 kg"	Slightly soiled laundry, laundry refreshment etc. - to save time and energy.	<ul style="list-style-type: none"> • spinning • pump stop (RH) • normal
 Sportswear	2,5 kg/ 2,5 kg/ 2,5 kg 2 kg"	Slightly soiled sportswear made of cotton, microfibers, synthetic fibres, at low spinning rate and with a short final spin.	<ul style="list-style-type: none"> • spinning • pump stop (RH) • normal • extra water • prewash
 Night Wash	3,5 kg/ 3,5 kg/ 3,5 kg 3 kg"	Mixed coloured laundry made of fabrics of different durability, with gentle tumbling, longer wash times, and lower spinning rate.	<ul style="list-style-type: none"> • spinning • pump stop (RH) • normal • extra water • prewash* (*except for at 🌀)
 Bio Wash	9 kg/ 8 kg/ 7 kg 6 kg"	Washing the laundry with very little to no detergent and by using eco wash balls.	<ul style="list-style-type: none"> • spinning • pump stop (RH) • normal

*Data for SLIM

Program:	Max. load	Type of laundry	Possible combinations
 Perfect Black	2,5 kg/ 2,5 kg/ 2,5 kg 2 kg"	Dark laundry using special-purpose detergents for black laundry, with gentle tumbling and lower spinning rates	<ul style="list-style-type: none"> • spinning • pump stop (RH) • normal
 Ultra White	2,5 kg/ 2,5 kg/ 2,5 kg 2 kg"	Delicate, slightly soiled laundry like bras, lace underwear, using special-purpose detergents for white delicate laundry... for washing at low temperatures with gentle tumbling and lower spinning rate.	<ul style="list-style-type: none"> • spinning • pump stop (RH) • normal
Partial programs	these are independent programs. Use them when you feel you do not need the entire washing program. Before selecting a new program, the washing machine has to be switched to "OFF" position for 1 second). Decrease spinning speed by pressing the (4) key.		
 Rinse	rinsing of the laundry (including hand washed laundry) without spinning between the rinsing cycles, with one final spinning cycle. "Extra water" can be selected by pressing the (6b) key.		
 Softening	for softening, starching, or impregnating previously washed laundry. It can also be used as a short rinse, but without adding any conditioner. It is completed with an additional rinse. "Extra water" can be selected by pressing the (6b) key.		
 Spinning/ pumping	for spinning the laundry. If you wish to pump out the water from the machine, without spinning, then press the (4) key several times to decrease the setting to "DRAIN".		

"Data for SLIM



Favourite Wash 1

To store a program, that you have customized.

First, select the program (rotate the program selector dial to the desired position) and adjust the settings as desired.

To save, press and hold the (7) and (6a) keys. The display will read "STYLE" P1 (NORM P1 ... ECO P1 ...) and an acoustic signal will be emitted.

The program will remain stored until you change it with the same procedure.



Favourite Wash 2

To store a program, that you have customized.

First, select the program (rotate the program selector dial to the desired position) and adjust the settings as desired.

To save, press and hold the (7) and (6b) keys. The display will read "STYLE" P2 (NORM P2 ... ECO P2 ...) and an acoustic signal will be emitted.

The program will remain stored until you change it with the same procedure.

4. STEP: CHOOSING THE SETTINGS

Each program features basic settings which, however, can be changed.

To change a setting, press the relevant key (before pressing the START/PAUSE key). Some settings cannot be selected with some programs; an acoustic signal and a flashing light will remind you of such cases (see Program Table).



2

Washing style (SensoCare)

NORM

NORMALcare
(basic settings)

ECO

EKOcare
(energy-saving wash - longer washing time, less water).

ALRG

ALERGYcare
(for laundry belonging to people who are particularly sensitive to detergents - using more water, with additional rinse)

TIME

TIMEcare
(time-saving wash - shorter washing time, more water).

Washing style (mode) is indicated on the display above the key.

3

Washing temperature

Changing the temperature on the selected program

Each program has a preset temperature which can be changed by pressing the (3) key.

Temperature is indicated in the display above the key.

4

Spinning

To change the spinning rate, in steps

Each program has a preset spinning rate which can be changed by pressing the (4) key. You may also choose to drain the water from the drum without any spinning (DRAIN).

The last setting is "stop pump"(RH) - the laundry remains soaked in water from the last rinse.

Use this option if you wish to prevent creasing of the laundry when you know you do not have the time to take it from the washing machine immediately after the washing program is completed.

Spinning rate is indicated in the display above the key.

5

Washing program completion (end) time

Set the time when you wish the washing program to end (e.g. 5 in the morning). The machine will calculate, given the selected program, when the wash has to begin.

By pressing the (5) key, you can adjust the time in 30-minute steps (up to 5 hours) and by 1-hour steps for periods longer than 1 hour.

Max. setting of the wash completion time is up to 1 day.

If nothing is pressed for 5 seconds, actual washing time will be displayed.

To reset the program end time, press the (5) key again.

Press the (5) key to display the estimated program end time on the display unit. (For example, if you choose a program that lasts 2:39 and press the (5) key, the time will "jump" to the first full hour, which is 3:00 in our case. Time will be counted down to 2:39; hence, the program will be launched after 21 minutes and it will be completed in 3 hours).

The function is activated when the START/PAUSE key is pressed.

After completion of the washing program, "END" is displayed on the display unit.

- to interrupt or change the program completion time, press the START/PAUSE key. Press the (5) key to select a new washing completion time and confirm it by pressing the START/PAUSE key.
- to quickly cancel the setting of washing completion time, press the (5) key and hold it for 3 seconds; then, press the START/PAUSE key to resume the washing program.
- In case of a power supply failure, press the START/PAUSE key to resume.

5. STEP: SELECTING ADDITIONAL FUNCTIONS

- 6a
- 6b
- 6c



To activate/deactivate a function, press the relevant key (before pressing the START/PAUSE key).

Some functions cannot be selected with some programs; an acoustic signal and a flashing light will remind you of such cases (see Program Table).

6a

Prewash

Washing heavily soiled laundry, particularly with stubborn superficial stains.

6b

ExtraWater

Washing with an extra amount of water and an additional rinse with some programs.

6c

SterilTub

Removing impurities, bacteria, and any unpleasant odour from the washing machine interior.

This setting can only be selected on the NORM Cotton 95°C program; press the (6c) key. CLN will appear on the display. No other function can be selected simultaneously.

Empty the washing machine drum and add some powder detergent. There should be no laundry in the washing machine during this program.

We recommend running the self-cleaning program at least once a month.

6b + 6c

Child Lock

A safety feature. To activate the child, press the (6b) and (6c) keys simultaneously and hold them for at least three seconds.

The selection will be confirmed by an acoustic signal and by a signal light (the key will be lit); the display will read "LOCK".

Follow the same procedure to deactivate the child lock.

As long as the child lock is activated, program, settings, or additional functions cannot be changed. The washing machine can only be switched off by rotating the program selector dial (1) to the "OFF" position.

Child lock remains active even after the washing machine is switched off. To select a new program, the child lock must first be deactivated.

ACOUSTIC SIGNAL

Select the acoustic signal loudness by simultaneously pressing the (6c) key and rotating the program selector dial (1) clockwise to the initial position. S1 will appear on the display. Each time a key is pressed, the final loudness level is changed (three levels; press the (6a) key to increase the setting and (6c) to decrease it.). Confirm the selection by pressing the (6b) key.

Selected loudness (sound volume) level is indicated on the display unit. The most recent setting is stored.

If nothing is pressed for 5 seconds, actual washing time will be displayed.



After disconnecting the appliance from the power mains, all settings will be reset to their default factory values, except for the acoustic signal loudness and child lock setting.

OPTIMIZING PROGRAM DURATION

Using advanced technology, the appliance perceives the amount of laundry in the early stage of the wash.

After detecting the amount of the load, the appliance automatically adjusts the program duration.

STANDBY MODE

If no program is selected and started and no other action is taken within five minutes after turning on the machine, the display will be automatically turned off to save energy. Signal light on the START/PAUSE key will flash.

The display will turn on again when you rotate the program selector dial or press any button.

If no action is taken after the end of the program, the display will also be turned off after five minutes. Signal light on the START/PAUSE key will flash.

P_o = weighted power in 'off mode' [W]	0,09
P_l = weighted power in the 'left on mode' [W]	1,16
T_l = time in 'left on mode' [min]	10,0



Low water temperature, low mains voltage and different washing load may affect the washing time; the remaining time displayed is adjusted accordingly during the washing process.

6. STEP: PROGRAM START

Press the (7) key START/PAUSE.



Selected washing mode, temperature, spinning rate, and washing program completion time (if selected) or remaining time will appear on the displays. Signal lights on the selected functions will be lit.



7. STEP: END OF WASHING PROGRAM

End of washing program will be signalled by an acoustic signal; "END" will appear on display.

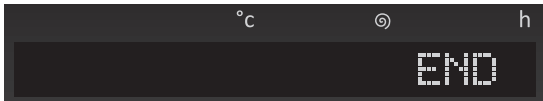

1. Open the washing machine door.
2. Take the laundry from the drum.
3. Close the door.
4. Shut off the water supply tap.
5. Switch off the appliance (rotate the program selector dial (1) to the "OFF" position).
6. Unplug the power cord from the outlet.

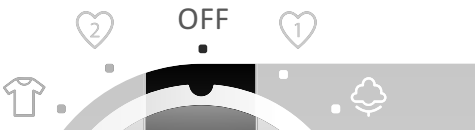

LEANING AND MAINTENANCE



Disconnect the washing machine from the mains before cleaning!

Do not allow children to clean the appliance or perform any maintenance tasks without proper supervision!

CLEANING THE DETERGENT DISPENSER

If necessary, clean the detergent dispenser.

Pull it out from its casing completely by pressing the flap.

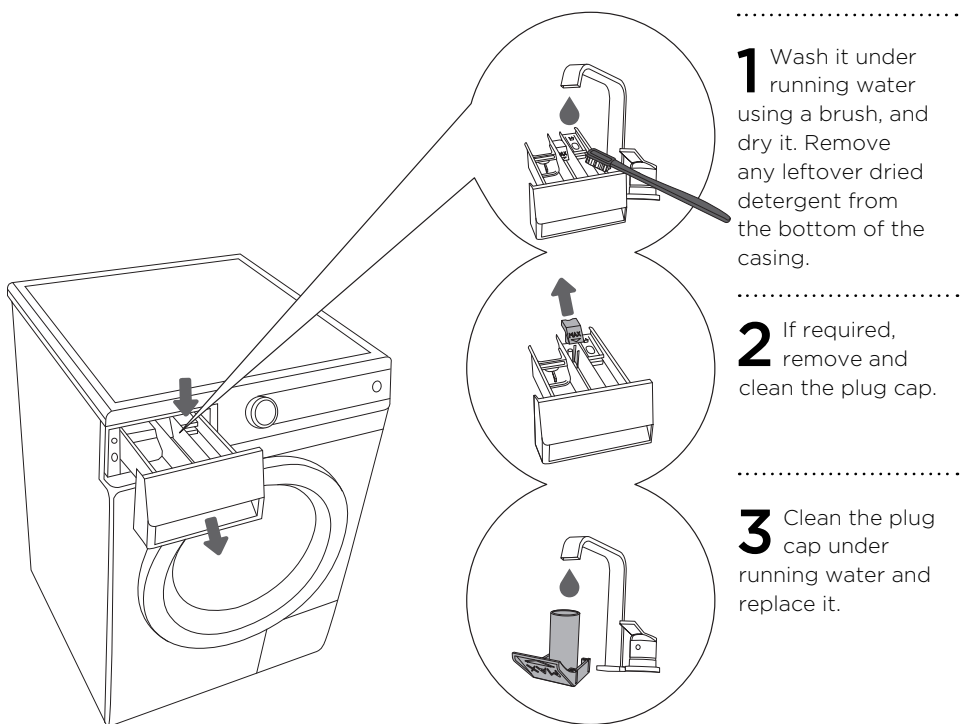

CLEANING THE DISPENSER HOUSING, INLET HOSE SCREEN AND DOOR RUBBER GASKET

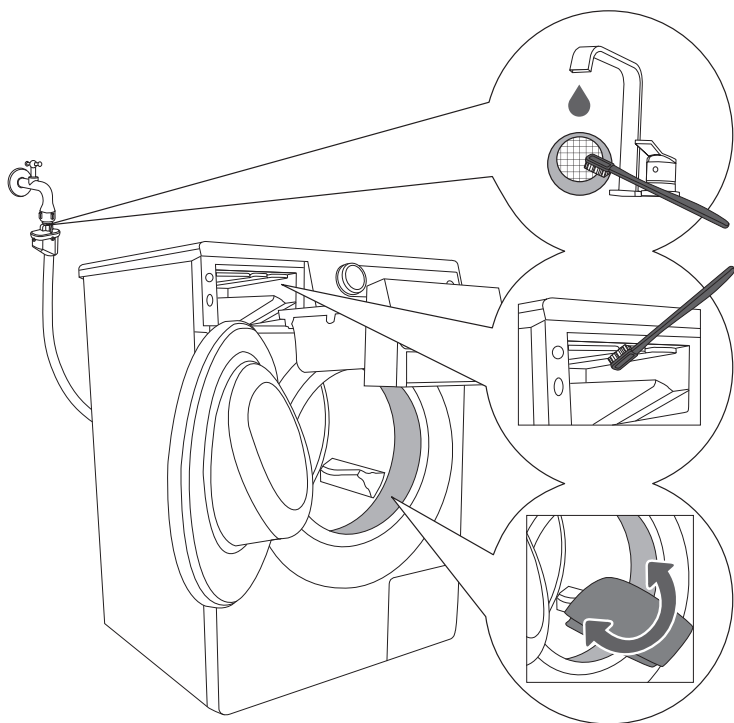

.....

1 Clean the water inlet hose screen frequently under running water.

.....

2 Clean the entire rinsing area of the washing machine with a brush, especially the nozzles on the upper side of the rinsing chamber.

.....

3 After each wash wipe the door rubber gasket. This will prolong its useful life.

CLEANING THE FILTER

During cleaning, some water may leak. Therefore, we recommend spreading an absorbent cloth on the floor before starting.

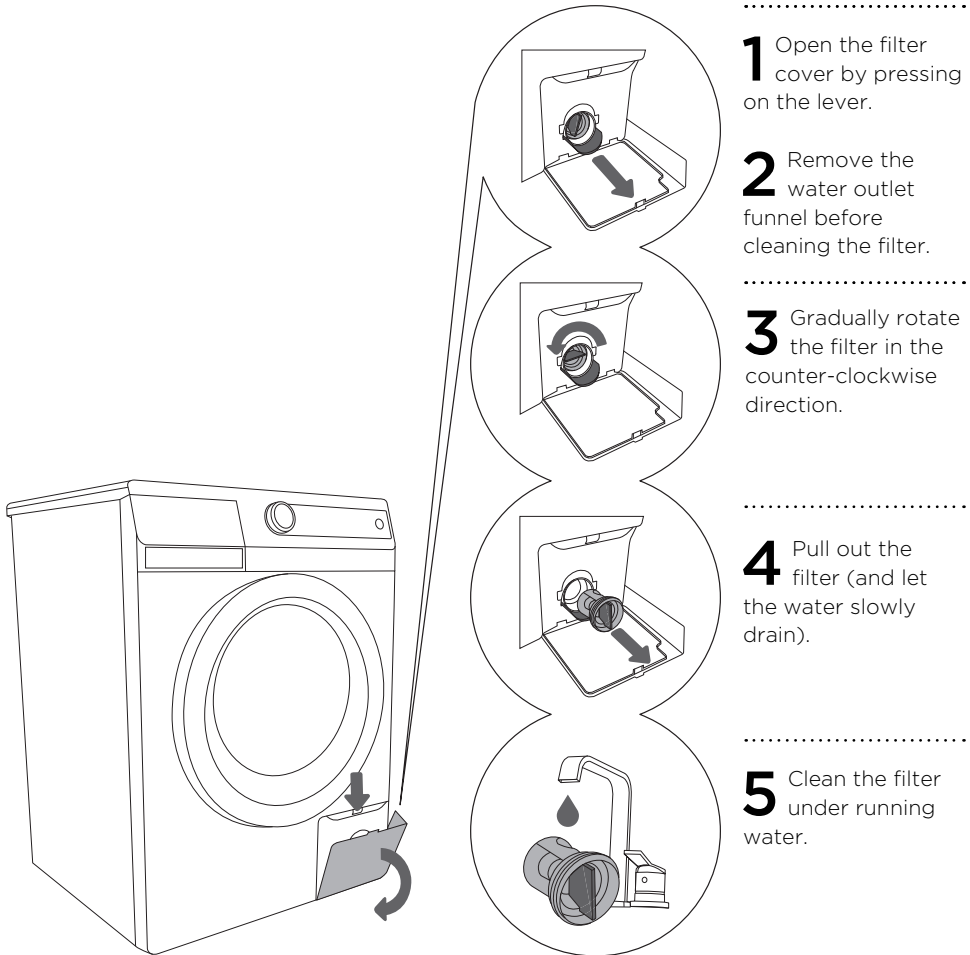

1 Open the filter cover by pressing on the lever.

2 Remove the water outlet funnel before cleaning the filter.

3 Gradually rotate the filter in the counter-clockwise direction.

4 Pull out the filter (and let the water slowly drain).

5 Clean the filter under running water.



Insert the filter back as shown on the picture, and tighten by turning it in clockwise direction. To ensure good sealing the gasket surface must be dirt free.

Filter needs occasional cleaning, especially following heavily shaggy or old laundry.

CLEANING THE WASHING MACHINE

The casing should be cleaned with soft cloth and mild detergent.

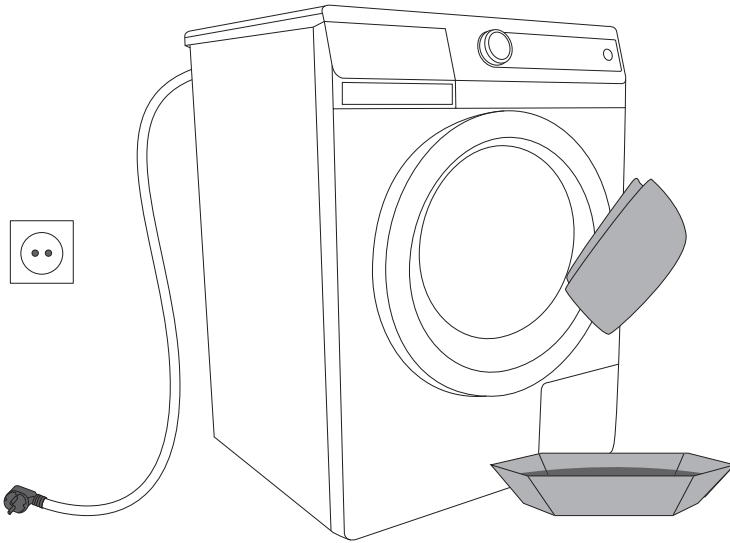

Disconnect the washing machine from the mains before cleaning!

Additional equipment and accessories for maintenance can be viewed on our website at: www.pelgrim.com

INERRUPTING AND CHANACING THE PROGRAM

Manual (physical) termination

The program can be cancelled / terminated by rotating the program selector dial (1) to the position. "OFF" position.

If there is water in the machine, select the additional program (spin + DRAIN) key (4)).

Personal settings

To save the most frequently used program Select the program and the settings, and save it as a present by holding the START/PAUSE key for 8 seconds. **CHD** will appear on the display.

The program will remain stored until it is changed (using the same procedure).

PAUSE KEY

The program can always be stopped by pressing the START/PAUSE. If there is no water in the drum, the door can be opened after a while; otherwise, the door cannot be opened. To resume the program, press the START/PAUSE key.

FAULTS

In case of a fault, the program will be interrupted. Flashing signal lights and an acoustic signal will warn about such occurrence (see section Troubleshooting), and the fault will be indicated on the display (ERR).

Power failure

At electric cutout the program is interrupted. When the power supply is re-established, press the START/PAUSE key to resume the washing program.

Washing time will resume from the point at which it was interrupted.



If a power failure occurs when the drum is still full of water, be careful not to open the door before you pump the water out. (see Programs/partial programs: Spinning/pumping).

WHAT TO DO ...?

The washing machine shall automatically control the operation of particular functions during the washing cycle.

If any irregularities are established, an error will be reported by indicating (ERR xx) on the display and emitting an acoustic signal.

The machine will signal the fault until it is turned off. If the fault is on the heating system, the machine will complete the washing program, but without heating the water.

Various interferences from the environment (e.g. electric devices) may also cause the machine to signal faults.

In such case:

- turn off the appliance and wait a few seconds,
- turn on the appliance and repeat the washing program.
- If the fault reoccurs, call the service center (Call centre).



The warranty does not cover faults caused by interference from the environment (lightning strike, electric circuit, natural disasters, etc.).

TROUBLESHOOTING TABLE

Failure	Possible cause	What to do...?
The machine does not work - the display is not lit.	<ul style="list-style-type: none"> Machine is not powered. 	Check if: <ul style="list-style-type: none"> power in the socket, the fuse is OK, plug is in the socket.
Water is leaking from the machine.	<ul style="list-style-type: none"> Filter is not tightly screwed in. Inlet pipe is not tightly screwed to the machine or to the water faucet. Outlet pipe fell to the floor. 	<ul style="list-style-type: none"> Tighten the filter properly. Tighten the inlet pipe. Affix the outlet pipe to the drain.
The machine moves during operation.	<ul style="list-style-type: none"> The machine is not properly levelled. Transport brackets are not removed. 	<ul style="list-style-type: none"> Level the machine with the adjustable legs. Remove transport brackets.
The machine vibrates during the spin.	<ul style="list-style-type: none"> Unevenly distributed laundry, especially with very small quantities (for ex. only the bathrobe). 	<ul style="list-style-type: none"> This is normal, the machine will reduce the RPM if vibrations are too strong. Wash larger quantity of laundry.
Excessive foaming during washing.	<ul style="list-style-type: none"> Excessive measure of detergent. 	<ul style="list-style-type: none"> Use washing powder according to the instructions by the producer and according to the water hardness and soiled laundry. Use only detergents for machine washing.
Laundry is not properly spun. No failure is reported.	<ul style="list-style-type: none"> The machine switched on the UKS* function. Because of bad laundry balance, the machine has automatically reduced spin RPM. 	<ul style="list-style-type: none"> The machine operates normally. Wash large and small pieces of laundry together.
Greasy wads appear on the laundry.	<ul style="list-style-type: none"> Too little detergent (laundry was very greasy). 	<ul style="list-style-type: none"> Wash the laundry again. Add more detergent for such soiled laundry, or use liquid detergent.
Laundry is stained after washing.	<ul style="list-style-type: none"> You used liquid detergent or detergent for coloured laundry which does not contain whitener. Unsuitable program has been selected. 	<ul style="list-style-type: none"> Use the detergent containing whitener. Use special stain removers.
White powdery residues on the laundry.	<ul style="list-style-type: none"> It is not the consequence of bad rinsing, but because of neo-phosphate detergents containing non soluble components (zeolites) for water softening. Such substances may be deposited upon the laundry. 	<ul style="list-style-type: none"> Immediately rinse the laundry once again. Use liquid detergents which do not contain zeolites. Try removing the residues with the brush
Detergent residues in the dispenser.	<ul style="list-style-type: none"> Low water flow pressure. Some detergents may stick to the dispenser rather hard if it is wet. 	<ul style="list-style-type: none"> Clean the inlet pipe filter net. Wipe the dispenser prior loading detergent.

Failure	Possible cause	What to do...?
Softener is not completely rinsed, or water is left in the dispenser dish.	<ul style="list-style-type: none"> • Sucking cover is not correctly positioned or is clogged. 	<ul style="list-style-type: none"> • Clean the dispenser and firmly fix the cover to its place.
Unpleasant smell in the washing machine drum.	<ul style="list-style-type: none"> • Remains of fabrics, washing agent and softener in the filter. • Development of germs. 	<ul style="list-style-type: none"> • Check whether the filter is clean. • Run the auto-clean (SterilTub) program (see chapter: selecting additional functions).
Washing time is longer than usual. Time indicated on the display is corrected during the washing cycle.	<ul style="list-style-type: none"> • Low temperature of inlet water. • The machine switched on the UKS* system because of uneven laundry load. • Low mains voltage. • There has been a failure in the power supply. 	<ul style="list-style-type: none"> • Washing program time may be up to 60% longer; however, this does not imply a fault in the machine. • Washing time is extended by the power supply down-time • Additional rinses may prolong the washing program time.
ERR 02 Washing program does not start • At the start of the washing cycle: washing time will flash	<ul style="list-style-type: none"> • Open door or door not properly closed. 	<ul style="list-style-type: none"> • Close the door by pushing it towards the machine. • Push START again.
ERR 03 Water is not supplied to the machine.	<ul style="list-style-type: none"> • Water level has not been reached. • Disturbed water inlet. 	Check if: <ul style="list-style-type: none"> • the water tap is open, • inlet pipe net filter is clean. • Push the START button.
ERR 06 Program temperature not reached.	<ul style="list-style-type: none"> • Heater failure. • Inlet water too cold. • Manual addition of water. 	<ul style="list-style-type: none"> • Turn off the appliance and wait for a few seconds. • Turn the appliance back on and repeat the washing program. • If the failure is reported again, call a service technician.
ERR 07 Water is poorly pumped out or not at all.	<ul style="list-style-type: none"> • Water outlet is clogged. 	Check if: <ul style="list-style-type: none"> • the filter is clean, • outlet pipe is not jammed, • the drain is clogged, • outlet pipe is positioned higher than 1m. • Push START again.

* UKS: universal stability control - this function prevents excessive vibrations during spinning

In case you were not successful in repairing the malfunctions in spite of the above suggestion chart, call the nearest authorized service shop. Repairing the failure arising from inappropriate connections or use of the appliance is not covered by the guarantee, and the repair expenses are paid by the customer.

RECOMMENDATIONS FOR WASHING AND ECONOMIC USE YOUR WASHING MACHINE

Wash new coloured garments separately the first time.

Wash heavily soiled laundry in smaller amounts, with more detergent or a prewash cycle.

Treat stubborn stains with a special stain removal agent before the wash. We recommend using the "Grandma's advice for natural stain removal".

With slightly soiled laundry, we recommend a program without prewash, use of shorter programs (e.g. Time Care) and a lower washing temperature.

Frequent, or predominant, washing at low temperatures, using liquid detergents, may result in development of bacteria which causes odour in the washing machine. To prevent this, we recommend running the auto-clean (SterilTub) program occasionally (see section WASHING/ selecting additional functions).

We recommend avoiding washing very small amounts of laundry as this will lead to excessive use of energy and poorer performance.

Loosen the stacked laundry prior inserting it into the drum.

Use only detergents for machine wash. Add the powder or liquid detergents as instructed by the manufacturer, according to the washing temperature and selected washing program.

If water hardness level exceeds 14°dH degrees, the use of water conditioner is required. Any damage to the heater due to failure to use a water conditioning agent shall not be covered by this warranty. Check the information on water hardness with your local water supply company or authority.

Chlorine-based whitening agents are not recommended, as it can damage the heater.

Do not add hardened balls of detergent into the detergent dispenser as this may clog the piping in the washing machine.

If you use thick liquid softener it is recommended to dilute it with water, to prevent clogging of dispenser compartment ducts.

Liquid detergents are intended for main wash only, without pre-wash.

High spin RPM leave less moisture in laundry which dries out much quicker in the tumble dryer, thereby saving energy.

Hardness scale	Degree of hardness			
	°dH (°N)	m mol/l	°fH(°F)	p.p.m.
1 - soft	< 8,4	< 1,5	< 15	< 150
2 - medium	8,4 - 14	1,5 - 2,5	15 - 25	150 - 250
3 - hard	> 14	> 2,5	> 25	> 250

In case of hard water add detergent according to the Chart for degree 1 and add appropriate quantity of water softener (see manufacturer's instructions)

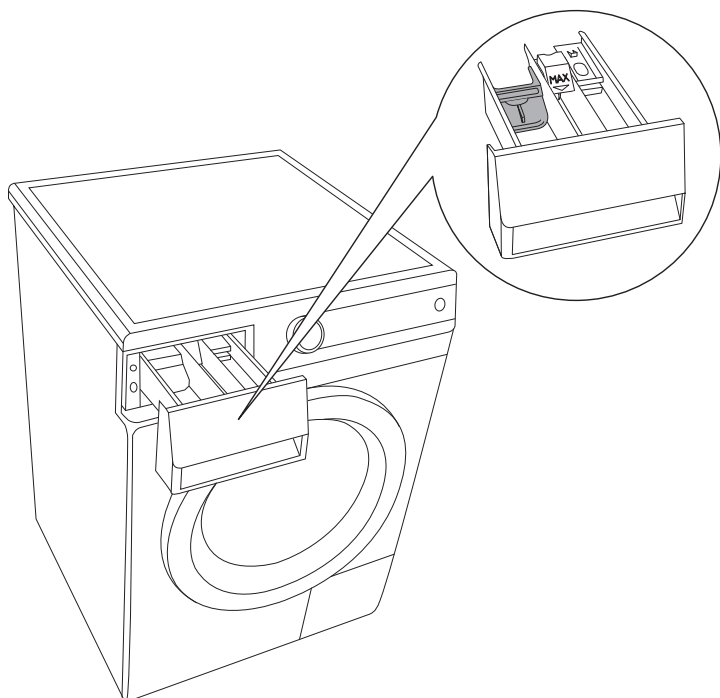

.....

Washing machine is equipped with the dispenser left gate, so you may pour liquid detergent also into the central compartment (depending on model). If you use powder detergent the gate is lifted up, and in case of liquid detergent it is slid down.

GRANDMA'S ADVICE FOR NATURAL STAIN REMOVAL

Before using special-purpose stain removers, try using the natural methods that do not harm the environment on less stubborn stains.

However, prompt action is required! Soak the stain with an absorbent sponge or a paper towel; then, rinse with cold (lukewarm) water - but never with hot water!

Stain	Stain removal
Colour lacquers	use paint thinner; rinse with soapsuds (test on a hidden spot first)
Blueberries	linen - soak in buttermilk; rinse with cold water first, then with warm water wool - first, apply lemon juice, then rinse silk - wipe with spirit (denatured alcohol)
Tea	rinse with cold water (stain removal soap, if required)
Chocolate	rinse with lukewarm soapsuds; apply lemon juice and rinse;
Ink	apply warm lemon juice; rinse apply milk, wait until it dries; rinse
Felt tip pens	use a mixture of vinegar and spirit/denatured alcohol (1:1); rinse apply warm lemon juice; rinse
Mustard	rinse with lukewarm water or soak with soda, rinse
Strawberries	soak in a mixture of vinegar and water
Eggs	sprinkle with salt and wait until it dries
Cocoa	white fabrics - soak in salt water
Curry, turmeric	use a solution of glycerine; rinse
Tar	apply regular or peanut butter; then wash
Coffee	rinse with salt water or soak in salt water
(Ball Point) Pen	spray with hair lacquer; dry, rinse with a mixture of vinegar and water, moisten with vodka and soak
Carrots	apply hard soap, soak in water, rinse
Shoe polish	apply cooking oil; rinse
Blood	rinse with cold water
Dried blood	soak the stain with water, soak in salt water, wash with soapsuds
Adhesive tape	iron; place a paper towel between the ironing board and the fabric

Stain	Stain removal
Glue	soak in spirit/denatured alcohol (or a mixture of vinegar and water); rinse
Make-up	use a glass cleaner and a paper towel
Butter	rinse with hot soapsuds (if the fabric permits);
Fat	tablecloth - sprinkle with baking soda, brush after a while wool - remove with mineral water use a mixture of baking soda + water (or toothpaste); dry; scrape off fresh stain - sprinkle with potato starch, then brush milk - rinse first with cold and then with hot water
Burnt parts	moisten the burnt parts (e.g. from ironing) with vinegar, lemon juice, or onion juice; rinse
Tomatoes	line the stain with slices of raw potato; rinse with warm soapsuds
Mould	soak in hot buttermilk; rinse with cold water
Sweat	soak in citric acid (12g/l of water); solution of borax; or in undiluted vinegar; wash delicate, wool - wipe with diluted vinegar silk - boil potatoes in unsalted water, cool, add some alcohol, and use the solution to wash the silk
Red beet	rinse with cold water (or apply borax), soak; wash
Red wine	sprinkle with salt, rub with lemon juice; rinse
Lipstick	rinse with lukewarm mixture of water and shampoo
Rust	coat with a mixture of lemon juice and salt; sundry (test on a hidden part first) soak in juice of cooked rhubarb stalk
Fruit	rinse with water, wipe the remaining part with vinegar or lemon juice; wash
Fruit juice	cover with salt and water; leave for 15 minutes to take effect; wash
Soot	do not rub, blow off, sprinkle with flour; alternatively, sprinkle with salt and beat out; or soak up with white bread
Resin	place the garment in a bag and freeze it; scrape the frozen stain; put butter or fat on wool and wash
Machine grease/lubricant	wipe with butter; wash
Spinach	rub with raw potatoes; wash
Stamps	rub with lemon and salt; rinse
Grass	apply diluted lemon juice; wash; if the stain is on jeans, apply toothpaste, dry, wash
Wax	place the garment in a bag and freeze; scrape the wax; place a paper towel on the rest and iron; wash
Chewing gum	place the garment in a bag and freeze; remove the gum

DISPOSAL

Our appliances are **packed** in environmentally friendly materials which may be recycled, deposited or decomposed without any threat to the environment.

To this end all wrappings are marked accordingly.



The symbol on the product or on its packaging indicates that this product may not be treated as household waste. Instead it shall be handed over to the applicable collection point for the recycling of electrical and electronic equipment.

When **disposing** of an obsolete appliance, make sure you remove the power cord and destroy the door switch and latch to prevent the door from closing (children safety).

By ensuring this product is **disposed** of correctly, you will help prevent potential negative consequences for the environment and human health, which could otherwise be caused by inappropriate waste handling of this product. For more detailed information about recycling of this product, please contact your local city office, your household waste disposal service or the shop where you purchased the product.

We reserve the rights to make any changes or mistakes in these operation instructions.

TYPICAL CONSUMPTION TABLE

Program	Max. load [kg]	Temp. [°C]	Spinning [rpm]	Duration [min.]	Water-Consumption [L]	Power-Consumption [kWh]
Cotton (A-50%) ECO*	9 / 4,5**	60	1000 - 1600	195 / 188**	63	0,82 / 0,75**
Cotton (A-50%) ECO*	9 / 4,5**	40	1000 - 1600	174 / 164**	63	0,77 / 0,66**
Cotton (A-50%) ECO*	8 / 4**	60	1000 - 1600	195 / 186**	59	0,73 / 0,66**
Cotton (A-50%) ECO*	8 / 4**	40	1000 - 1600	174 / 164**	59	0,67 / 0,63**
Cotton (A-40%) ECO*	9 / 4,5**	60	1000 - 1600	195 / 188**	66	0,95 / 0,82**
Cotton (A-40%) ECO*	9 / 4,5**	40	1000 - 1600	174 / 164**	66	0,77 / 0,66**
Cotton (A-40%) ECO*	8 / 4**	60	1000 - 1600	195 / 186**	61	0,80 / 0,72**
Cotton (A-40%) ECO*	8 / 4**	40	1000 - 1600	174 / 164**	61	0,77 / 0,65**
Cotton (A-40%) ECO*	7 / 3,5**	60	1000 - 1600	195 / 181**	49	0,77 / 0,62**
Cotton (A-40%) ECO*	7 / 3,5**	40	1000 - 1600	174 / 164**	49	0,65 / 0,55**
Cotton (A-30%) ECO*	8 / 4**	60	1000 - 1600	195 / 186**	61	0,92 / 0,88**
Cotton (A-30%) ECO*	8 / 4**	40	1000 - 1600	174 / 164**	61	0,75 / 0,72**
Cotton (A-30%) ECO*	7 / 3,5**	60	1000 - 1600	195 / 181**	51	0,84 / 0,73**
Cotton (A-30%) ECO*	7 / 3,5**	40	1000 - 1600	174 / 164**	51	0,67 / 0,58**
SLIM						
Cotton (A-30%) ECO*	6 / 3**	60	1000 - 1400	195 / 168**	49	0,79 / 0,64**
Cotton (A-30%) ECO*	6 / 3**	40	1000 - 1400	174 / 162**	49	0,55 / 0,48**
Cotton (A-20%) ECO*	6 / 3**	60	1000 - 1400	195 / 168**	51	0,89 / 0,71**
Cotton (A-20%) ECO*	6 / 3**	40	1000 - 1400	174 / 162**	51	0,60 / 0,52**

* Testing program by EN 60456 with the selection of max. spin RPM

** Half load

'Standard 60°C ECO cotton programme' and the 'standard 40°C ECO cotton programme' are the standard washing programmes to which the information in the label relates. These programmes are suitable for cleaning normally soiled cotton laundry and they are the most efficient programmes in terms of combined energy and water consumption. For this reason, actual water temperature may differ from the nominal cycle temperature.



Due to deviations in terms of type and amount of laundry, spinning, power supply oscillation, and environment temperature and humidity, the values measured at the user may differ from the one stated in the table.

