

*Dishwasher*  
*Instruction Manual*

**PVW6030WIT/P01**

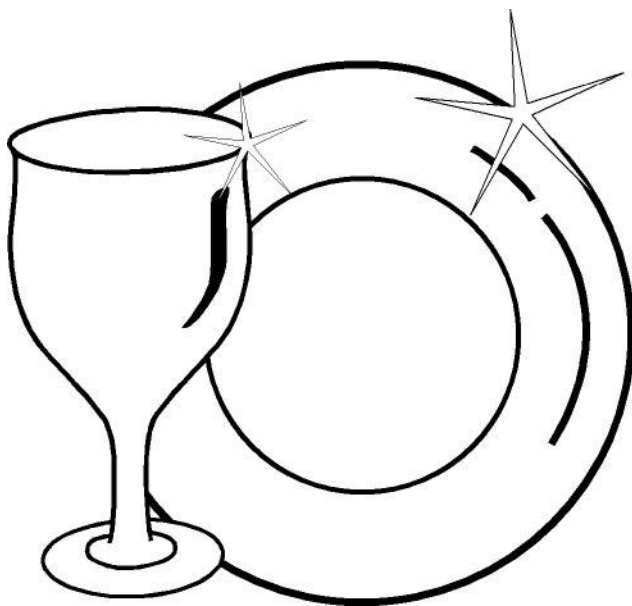

**Pelgrim**

## CONTENTS

<b>Getting familiar with your machine .....</b>	<b>4</b>
• Technical specifications .....	6
• Conformity with the standards and Test data .....	6
<b><i>Safety information and Recommendations.....</i></b>	<b>6</b>
• Recycling .....	6
• Safety information .....	6
• Recommendations .....	7
• Items not suitable for dishwashing .....	8
<b><i>Installing the machine .....</i></b>	<b>8</b>
• Positioning the machine .....	8
• Water connections .....	8
• Water inlet hose .....	9
• Water outlet hose .....	9
• Electrical connection.....	9
• Fitting the machine undercounter .....	10
• Prior to using the machine .....	12
<b><i>Preparing the machine for use .....</i></b>	<b>12</b>
• The importance of water decalcification .....	12
• Filling with salt .....	12
• Testing strip.....	13
• Adjusting salt consumption.....	13
• Detergent usage .....	15
• Filling the detergent compartment.....	15
• Combined detergent.....	15
• Filling with rinse aid and making the setting.....	16

<b>Loading your dishwasher .....</b>	<b>17</b>
• Alternative basket loads .....	22
• Standard loading and Test data .....	23
<b>Programme descriptions .....</b>	<b>2(</b>
• Programme items .....	24
<b>Switching on the machine and selecting a programme.....</b>	<b>2)</b>
• Switching on the machine.....	25
• Programme follow-up .....	25
• Changing a programme .....	25
• Changing a programme with resetting .....	26
• Switching the machine off .....	26
<b>Maintenance and Cleaning .....</b>	<b>2+</b>
• Filters .....	27
• Spray arms .....	28
• Hose filter .....	28
<b>Failure codes and what to do in case of failure .....</b>	<b>2-</b>
<b>Practical and useful information.....</b>	<b>' %</b>

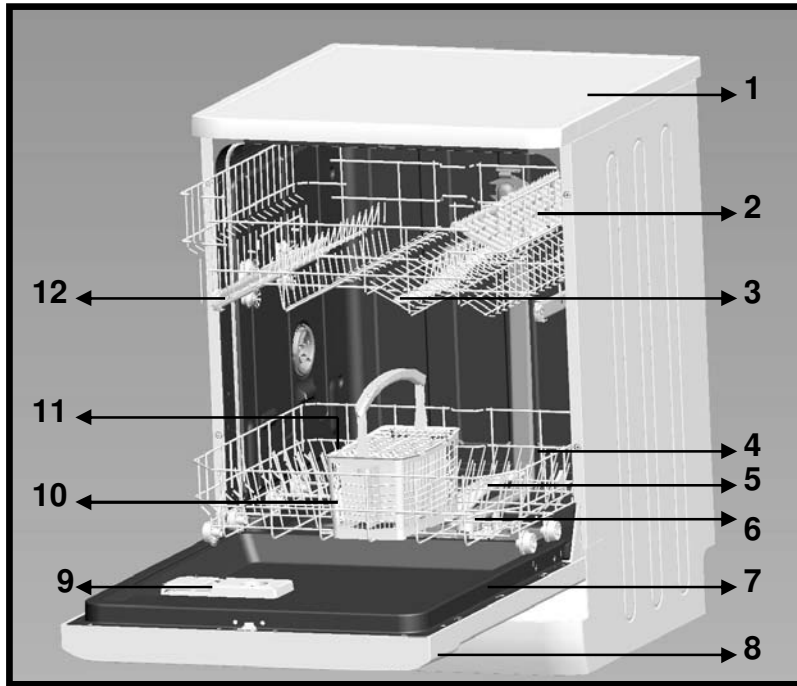

**Turbo Drying Unit:** This system provides better drying performance for your dishes.

- |                            |                                      |
|----------------------------|--------------------------------------|
| 1. Worktop                 | 7. Rating plate                      |
| 2. Upper basket with racks | 8. Control Panel                     |
| 3. Upper spray arm         | 9. Detergent and rinse-aid dispenser |
| 4. Lower basket            | 10. Cutlery basket                   |
| 5. Lower spray arm         | 11. Salt dispenser                   |
| 6. Filters                 | 12. Upper basket track latch         |

## GETTING FAMILIAR WITH YOUR MACHINE

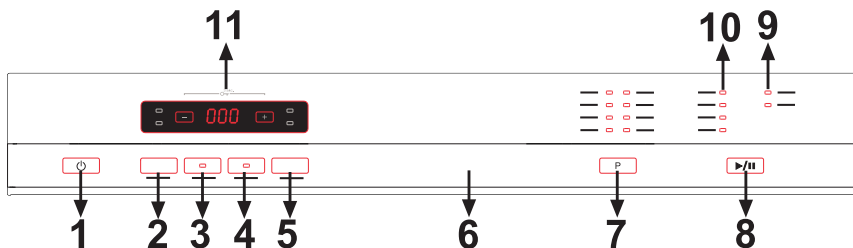

### 1.) ON/OFF Button

When pressed on ON/OFF button, the machine is energized and the light on Start/Standby button goes on.

### 2.) Extra Rinse / Dry Button

You can add extra rinsing or drying functions into the selected program by using extra button.

Once you selected extra rinsing function, the light for extra rinsing on the left upper - hand side of the indicator will come on, and thus washing-rinsing steps will be added into the selected program, so you can ensure that your dishes will be extracted cleaner and glossier.

Once you selected, extra drying function, the light for extra drying on the left lower -hand side of the indicator will come on, and thus the extra heating and drying steps will be added into the selected program, so you can ensure that your dishes will be extracted dryer.

### 3.) Extra Hygiene Button





By using this option, washing temperature and periods during respective cycles may be changed, which ensures more hygienic washing.



### 4.) Tablet Detergent Button



Push Tablet Detergent button when using combined detergent that contains salt, rinse aid and extra functions.

### 5.) ½ Half Load Button

Using the function ½, three sorts of washing up can be done those being lower basket, upper basket and both baskets.

  If you have little amount of dishes in your machine 1/2 and if you have to wash them, you can also   activate the semi-filling function in some of the programs additionally. If you have dishes in both baskets, press the key 1/2 and select the position in which both lamps are highlighted.

  If you have dishes only in the upper basket, pres the key 1/2 and select the position in which the upper lamp is illuminated. Thus, washing up shall be done only on the upper basket of your machine. No dishes should certainly be available in the lower basket while using this feature.

  If you have dishes only in the lower basket, press the key 1/2 and select the position in which the lower lamp is illuminated.

Thus, washing up shall be done only on the lower basket of your machine. In using this feature, make sure that there are no dishes in the upper basket.

**Note :** If you have used an extra feature on the latest washing program, this feature will remain active also on the next washing program. If you do not want to use this feature on the newly selected washing program, press the selected feature button again, and check that the lamp on the button goes off.

#### **6.) Door Handle**

The door handle is used to open/close the door of your machine.

#### **7.) Programme selector Button**

With the program selector button, you can select a suitable program for your dishes.

#### **8.) Start/Pause Button**

Once you press the Start/Pause button, the programme you selected with the programme selector button will start running and the status indicator lamp "wash" will light up. In the stop condition while wash led is On, Start/Pause led will blink.

#### **9.) Salt Lack Warning indicator**

In order to see whether softening salt in your machine is sufficient or not, check salt lack warning light on the display. When salt light warning light starts coming on, you need to fill in the salt chamber.

#### **Rinse aid Lack Warning indicator**

In order to check that there is sufficient rinse aid in your machine check rinse aid lack warning light on the display. When rinse aid warning light starts coming on, fill in rinse aid chamber.

#### **10.) Program Monitor Lights**

Program flow can be monitored via program monitor lights on control panel.

- Wash
- Rinse
- Dry
- End

#### **11.) Remaining Time Indicator**

Remaining Time Indicator displays the program times and remaining time during the program is in operation. In addition, you can adjust program delay time by pressing the buttons on the indicator before program starts. If you want to change delay time, you can set the time by pressing Start/Pause button and using buttons on the indicator. Press Start/Pause button again in order to activate.

#### **Child Lock Operation**

In order to activate child lock, press "+" and "-" buttons on Remaining time indicator simultaneously 3 for seconds. At this time, "CL" appears for 2 seconds on remaining time indicator. To inactive child lock, press "+" and "-" buttons again simultaneously for 3 seconds. "CL" will blink for 1 times.

## Technical specifications

Capacity .....	15 place settings
Height .....	845 mm
Height (without worktop) .....	815 mm
Width .....	596 mm
Depth .....	598 mm
Net Weight .....	55 kg
Electricity input .....	220-240 V, 50 Hz
Total Power .....	2200 W
Heating Power .....	2000 W
Pump Power .....	100 W
Drain Pump Power .....	30 W
Water supply pressure.....	0.03 MPa (0,3 bar) - 1 MPa (10 bar)
Current .....	10 A

- Producer company has its right to amend design and technical specifications reserved.
- The machine's service life is 10 years (the duration required to keep spare parts for the machine to fulfil its usage functions).

### **Conformity with the standards and Test data / EC Declaration of Conformity**

All stages related to the machine are executed in accordance with the safety rules provided in all relevant directives of the European Community.

2004/108/EC, 2006/95/EC, IEC 436/DIN 44990, EN 50242

## **SAFETY INFORMATION AND RECOMMENDATIONS**

### **Recycling**

- Certain components and the packaging of your machine have been produced from recyclable materials.
- Plastic parts are marked with international abbreviations:  
(>PE<, >PS<, >POM<, >PP<, ....)
- Cardboard parts have been produced from recycled paper and they should be disposed of into waste paper collection containers for recycling.
- Such materials are not suitable for being disposed of into garbage bins. They should be delivered to recycling centres instead.
- Contact relevant centres in order to obtain information on methods and points of disposal.

### **Safety Information**

#### ***When you take delivery of your machine***

- Check for any damage to your machine or to its packaging. Never start a machine damaged in any way, make sure to contact an authorised service.
- Unwrap the packaging materials as indicated and dispose of them in accordance with the rules.

#### ***The points to pay attention during machine installation***

- Choose a suitable, safe and level place to install your machine.
- Carry out the installation and connection of your machine by following the instructions.
- This machine should be installed and repaired by an authorised service only.
- Only original spare parts should be used with the machine.
- Before installing, be sure that the machine is unplugged.
- Check whether the indoor electrical fuse system is connected according to the regulations.

- All electrical connections must match the values indicated on the rating plate.
- Pay special attention and be sure that the machine does not stand on the electricity supply cable.
- Never use an extension cord or a multiple socket for making a connection. The plug should be comfortably accessible after the machine has been installed.
- After installing the machine to a suitable place, run it unloaded for the first time.

#### ***In daily use***

- This machine is for household use; do not use it for any other purpose. Commercial usage of the dishwasher will void the guarantee.
- Do not get up, sit or place a load on the open door of the dishwasher, it may fall over.
- Never put into the detergent and rinse aid dispensers of your machine anything other than those detergents and rinse aids which are produced specifically for dishwashers. Our company will not be responsible for any damage that might occur in your machine otherwise.
- The water in the machine's washing section is no drinking water, do not drink it.
- Due to danger of explosion, do not put into the machine's washing section any chemical dissolving agents such as solvents.
- Check whether plastic items are heat-resistant before washing them in the machine.
- Do not put into your machine those items which are not suitable for dishwashing. Also, do not fill any basket above its capacity. Our company will not be responsible for any scratch or rust to form on the inner frame of your machine due to basket movements otherwise.
- Especially because hot water may flow out, the machine door should not be opened under any circumstances while the machine is in operation. In any case, a safety device ensures that the machine stops if the door is opened.
- Do not leave your dishwasher's door open. Failure to do so may lead to accidents.
- Place knives and other sharp-ended objects in the cutlery basket in blade-down position.
- This appliance is not intended for use by persons (including children) with reduced physical, sensory or mental capabilities, or lack of experience and knowledge, unless they have been given supervision or instruction concerning use of the appliance by a person responsible for their safety.

#### ***For your children's safety***

- After removing the machine's packaging, make sure that the packaging material is out of reach of children.
- Do not allow children to play with or start the machine.
- Keep your children away from detergents and rinse aids.
- Keep children away from the machine while it is open because there may still be residues of cleaning substances inside the machine.
- Be sure that your old machine does not pose any threat to your children. Children are known to have gotten themselves locked in old machines. To forestall such a situation, break your machine's door lock and tear off the electrical cables.

#### ***In case of malfunctioning***

- Any malfunction in the machine should be repaired definitely by qualified persons. Any repair work performed by anyone other than the authorised service personnel will cause your machine to be left outside the scope of warranty.
- Prior to any repair work on the machine, be sure that the machine is cut off from the mains. Switch off the fuse or unplug the machine. Do not pull by the cable when unplugging. Make sure to turn off the water tap.

#### ***Recommendations***

- For energy and water saving, remove coarse residues on your dishes before placing the dishes into the machine. Start your machine after having fully loaded it
- Use the pre-wash programme only whenever necessary.
- Place such hollow items as bowls, glasses and pots into the machine in such a way that they will face down.



- You are recommended not to load into your machine any dishes different or more than indicated.

***Items not suitable for dishwashing:***

- Cigarette ashes, candle leftovers, polish, paint, chemical substances, iron-alloy materials;
- Forks, spoons and knives with wooden or bone, or ivory or nacre-coated handles; glued items, items soiled with abrasive, acidic or base chemicals
- Plastic items that are not heat-resistant, copper or tin-coated containers;
- Aluminium and silver objects (they may discolour, become dull)
- Certain delicate glass types, porcelains with ornamental printed patterns as they fade even after the first wash; certain crystal items as they lose their transparency over time, adhered cutlery that is not heat-resistant, lead crystal glasses, cutting boards, items manufactured with synthetic fibre;
- Absorbent items as sponges or kitchen rags are not suitable for dishwashing.

**Warning:** Take care to buy dishwasher-proof sets in your future purchases.

## ***INSTALLING THE MACHINE***

***Positioning the machine***

When determining the place to put your machine on, take care to choose a place where you can easily load and unload your dishes.

Do not put your machine in any location where there is the probability for the room temperature to fall below 0°C.

Before positioning, take the machine out of its packaging by following the warnings located on the package.

Position the machine close to a water tap or drain. You need to site your machine, taking into consideration that its connections will not be altered once they are made.

Do not grip the machine by its door or panel in order to move it.

Take care to leave a certain clearance from all sides of the machine so that you can comfortably move it back and forth during cleaning.

Make sure that the water inlet and outlet hoses do not get squeezed while positioning the machine.

Also, make sure that the machine does not stand on the electrical cable.

Adjust the machine's adjustable feet so that it can stand level and balanced. Proper positioning of the machine ensures problem-free opening and closing of its door.

If the door of you machine does not close properly, check if the machine is stable on the floor it stands; if not, adjust the adjustable feet and ensure its stable position.

***Water connection***

Be sure that the indoor plumbing is suitable for installing a dishwasher. Also, we recommend that you fit a filter at the entrance of your place or apartment so as to avoid any damage to your machine because of any contamination (sand, clay, rust etc.) that might be occasionally carried in through the mains water supply or the indoor plumbing, and to forestall such complaints as yellowing and formation of deposits after washing.

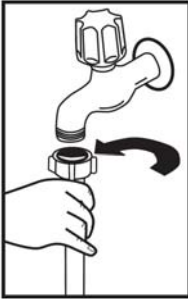

### **Water inlet hose**

Do not use the water inlet hose of your old machine, if any. Use the new water inlet hose supplied with your machine instead. If you are going to connect a new or long-unused water inlet hose to your machine, run water through it for a while before making the connection. Connect the water inlet hose directly to the water inlet tap. The pressure supplied by the tap should be at a minimum of 0.03 Mpa and at a maximum of 1 Mpa. If the water pressure is above 1 Mpa, a pressure-relief valve should be fitted inbetween. After the connections are made, the tap should be turned on fully and checked for water tightness.

For the safety of your machine, make sure to always turn off the water inlet tap after each wash programme is finished.

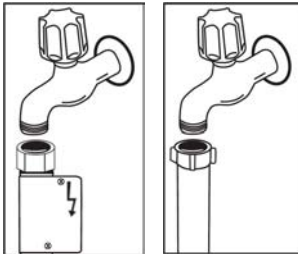

**NOTE:** Aquastop water spout is used in some models. In case of using Aquastop, a dangerous tension exists. Do not cut Aquastop water spout. Do not let it get folded or twisted.

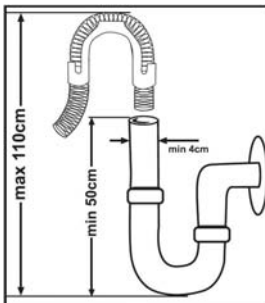

### **Water outlet hose**

The water drain hose can be connected either directly to the water drain hole or to the sink outlet spigot. Using a special bent pipe (if available), the water can be drained directly into the sink via hooking the bent pipe over the edge of the sink.

This connection should be at a minimum of 50 cm and at a maximum of 110 cm from the floor plane.

**Warning:** When a drain hose longer than 4 m is used, the dishes might remain dirty. In that case, our company will not accept responsibility.

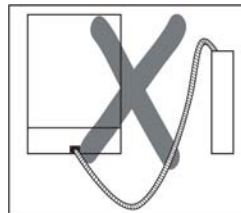
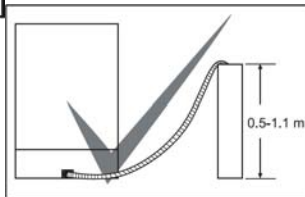

### **Electrical connection**

The earthed plug of your machine should be connected to an earthed outlet supplied by suitable voltage and current. If there is no earthing installation, have a competent electrician carry out an earthing installation. In case of usage without earthing installed, our company will not be responsible for any loss of usage that might occur.

The indoor fuse current value should be 10-16 A.

Your machine is set according to 220-240 V. If the mains voltage in your location is 110 V, connect a transformer of 110/220 V and 3000 W inbetween. The machine should not be plugged in during positioning.

Always use the coated plug supplied with your machine.

Running in low voltage will cause a decline in washing quality.

The machine's electrical cable should be replaced by an authorised service or an authorised electrician only. Failure to do so may lead to accidents.

For safety purposes, always make sure to disconnect the plug when a wash programme is finished.

In order not to cause an electric shock, do not unplug when your hands are wet.

When disconnecting your machine from the mains supply, always pull from the plug. Never pull the cord itself.

### **Fitting the machine undercounter**

If you wish to fit your machine undercounter, check whether you have sufficient space under your countertop and whether the wiring-plumbing is suitable to do so. **1** If you decide that the space under the countertop is suitable for fitting your machine, remove the worktop as shown in the illustration. **2** To remove the worktop, remove the screws that hold the worktop which are located at the rear of the machine; then push the front panel 1 cm from the front side towards the rear and lift it.

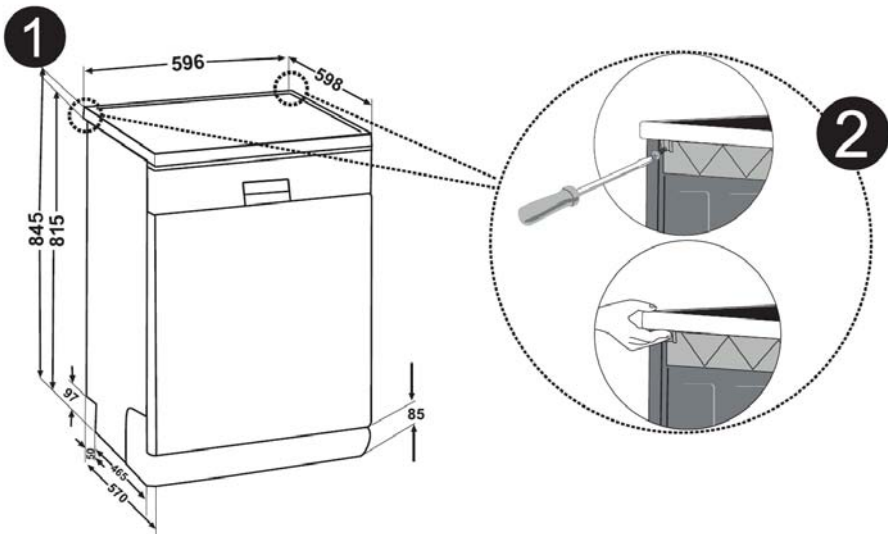

**Warning:** The stand part which we will settle our machine under it by removing its worktop has to be stable in such a way not to allow balance disorder.

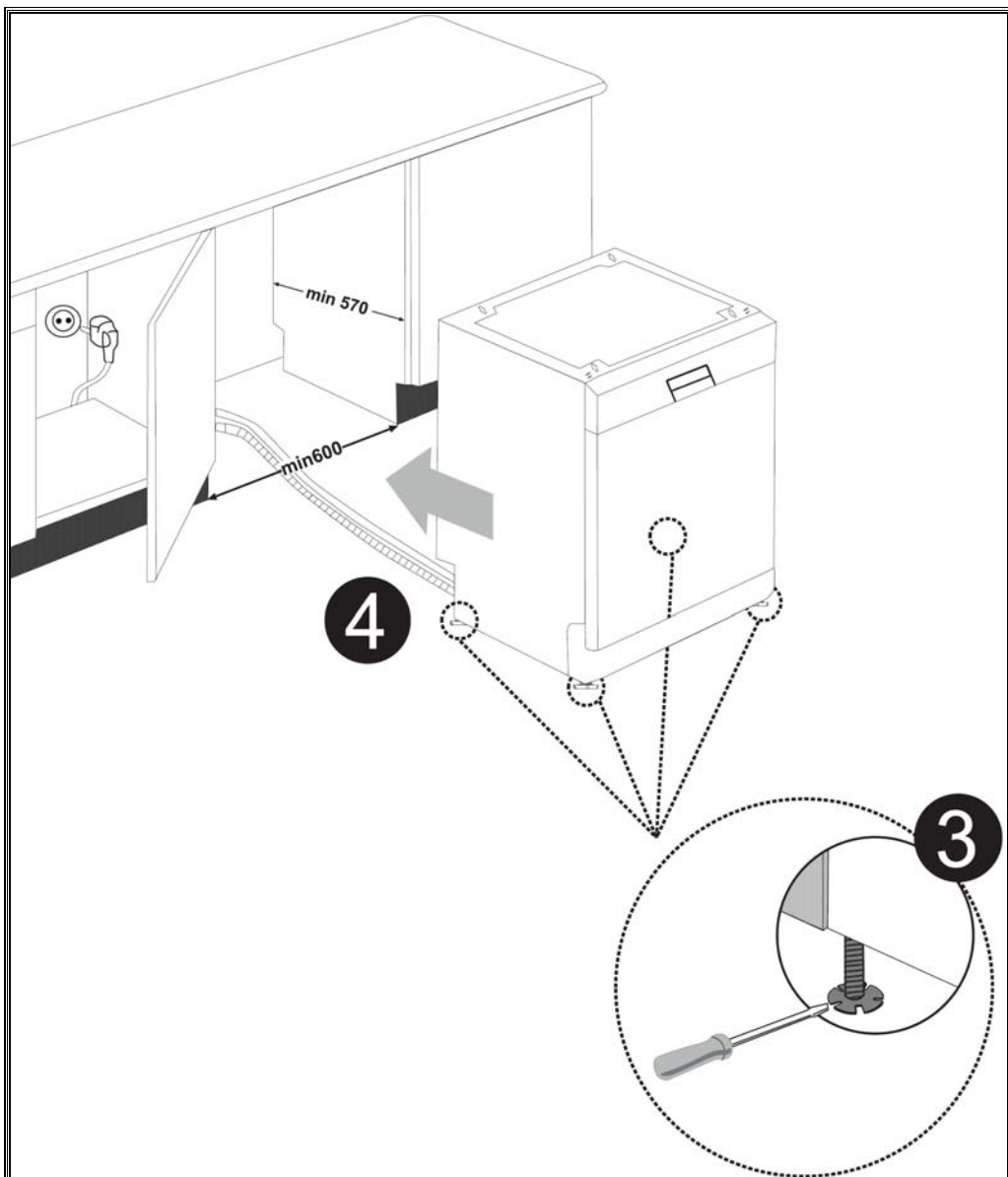

Adjust the machine feet according to the slope of the floor. **3** Fit your machine by pushing it undercounter without letting the hoses get crushed or bent. **4**

**Warning:** After removal of worktop, the machine should be placed in such a closed place of which dimensions are shown at fig.

### **Prior to using the machine for the first time**

- Check whether the electricity and supply water specifications match the values indicated by the installation instructions for the machine.
- Remove all packaging materials inside the machine.
- Set the water softener.
- Add 2 kg salt into the salt compartment and fill with water up to a level at which it will almost overflow.
- Fill the rinse aid compartment.

## **PREPARING THE MACHINE FOR USE**

### **The importance of water decalcification**

For a good washing function, the dishwasher needs soft, i.e. less calcareous water. Otherwise, white lime residues will remain on the dishes and the interior equipment. This will negatively affect your machine's washing, drying and shining performance. When water flows through the softener system, the ions forming the hardness are removed from the water and the water reaches the softness required to obtain the best washing result. Depending on the level of hardness of the inflowing water, these ions that harden the water accumulate rapidly inside the softener system. Therefore, the softener system has to be refreshed so that it operates with the same performance also during the next wash. For this purpose, dishwasher salt is used.

### **Filling with salt**

Use softener salt specifically produced for use in dishwashers. To put softener salt, first remove the

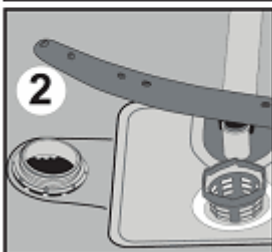
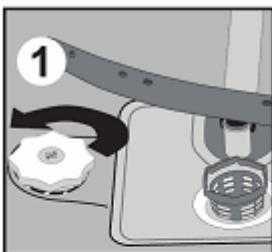

lower basket and then open the salt compartment cap by turning it counter clockwise. **1** **2** At first fill the compartment with 2kg salt and water **3** at overflowing level. If available, using the funnel **4** provided will make filling easier. Refit the cap and close it. If the salt warning lamp on the control panel becomes on, fill the salt compartment with salt again.

### **Fill the salt compartment with water at first use only.**

If you put a tablet into the salt compartment, do not fill the compartment completely. We recommend that you use small-grained or powder softener salt. Do not put table salt into your machine. Otherwise, the function of the softener compartment may

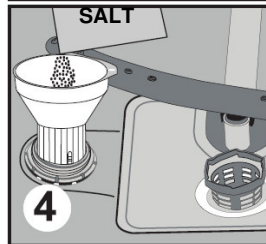
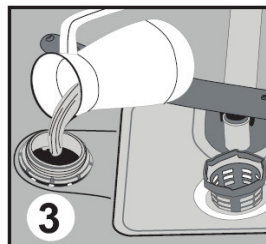

decrease over time. When you start your dishwasher, the salt compartment gets filled with water. Therefore, put the softener salt prior to starting your machine. This way, overflowing salt gets immediately cleaned up through the wash operation. If you are not going to wash any dishes immediately after putting salt, then run a short washing program with an empty machine in order to avoid any damage (to prevent corrosion) to your machine due to the salt overflow while filling in the salt container.

### Testing strip

The washing effectiveness of your machine depends on the softness of the tap water. For this reason, your machine is equipped with a system that reduces the hardness in mains water supply. The washing effectiveness will increase when the system is correctly set. To find out the water hardness level of water in your area, contact your local water board or determine water hardness level by using the test strip(if available).

Open the testing strip.	Run water through your tap for 1 min.	Keep the testing strip in water for 1 sec.	Shake the testing strip after taking it out of water.	Wait for 1 min.	Make your machine's water hardness setting according to the result obtained through the testing strip.
-------------------------	---------------------------------------	--	---	-----------------	--

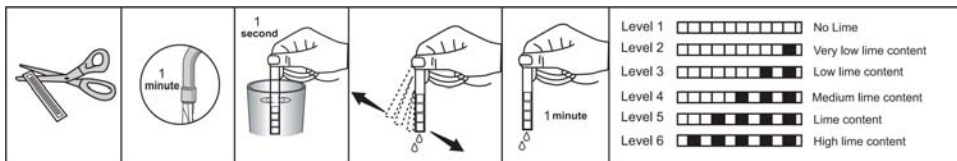

### Adjusting salt consumption

#### Table of Water Hardness Level Settings

Water hardness level	German hardness dH	French hardness dF	British hardness dE	Hardness Level Indicator
1	0-5	0-9	0-6	L1 is seen on display.
2	6-11	10-20	7-14	L2 is seen on display.
3	12-17	21-30	15-21	L3 is seen on display.
4	18-22	31-40	22-28	L4 is seen on display.
5	23-31	41-55	29-39	L5 is seen on display.
6	32-50	56-90	40-63	L6 is seen on display.

If the hardness of the water you use is above 90 dF (French hardness) or if you are using well water; you are recommended to use filter and water refinement devices.

**NOTE:** Hardness level is adjusted to level 3 as a factory setting.

Adjust water hardness setting of your machine according to the level specified on the test track.

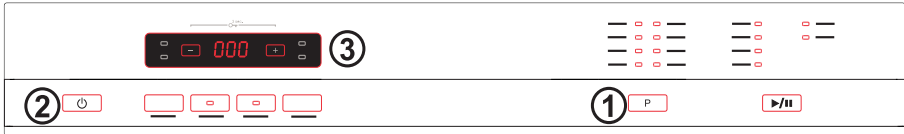

Push the Programme selection button and hold down. **1**



In the meantime, energize the machine by pushing ON/OFF button. **2**



Hold down the programme selection button until "SL" on the screen goes off. After "SL" goes off, release the programme button. **1**

The machine will show the last water softening setting carried out.



You can make water hardness setting by pressing on "+" and "-" buttons on the display. **3**



After making water hardness setting, memorize the chosen setting by pushing ON/OFF button.

### **Detergent usage**

Use a detergent specifically designed for use in domestic dishwashers. You can find powder, gel, and tablet detergents in the market that have been designed for household dishwashers.

Detergent should be put into the compartment prior to starting the machine. Keep your detergents in cool, dry places out of reach of your children.

Do not fill detergent into the detergent compartment more than required; otherwise it may cause scratches on your glasses as well as lead to a poorly dissolved detergent.

Should you need more information concerning the detergent you will use, contact detergent manufacturers directly.

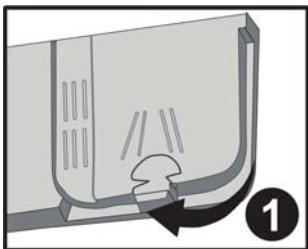

### **Filling the detergent compartment**

Push the latch to open the detergent container as shown in the image. **1** Detergent pod has level lines inside. It is possible to measure the right detergent amount using these lines. Detergent pod can take totally 40 cm<sup>3</sup> detergent.

Open the dishwasher detergent and pour into

the larger compartment **b** 25 cm<sup>3</sup> if your dishes are heavily soiled or 15 cm<sup>3</sup> if they are less soiled. **2** If your dishes have been kept dirty for a very long time, if there are dried food wastes on them, and if you have overloaded the dishwasher, pour **a** 5 cm<sup>3</sup> detergent into the pre-wash compartment and start your machine.

You may have to add more detergent into your machine, depending on the degree of soil and on the water hardness level in your area.

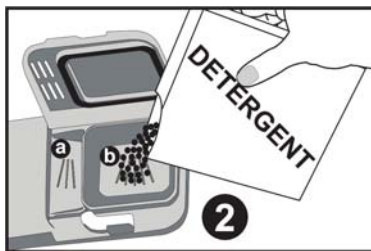

### **Combined detergent**

Detergent manufacturers also produce combined detergents called "2 in 1", "3 in 1" or "5 in 1" etc.

"2 in 1" detergents contain detergent + salt or rinse aid. When using "2 in 1" detergents make sure to check the specifications of the tablet.

Other tablet detergents contain detergent + rinse aid + salt + various extra functions.

Generally, combined detergents produce sufficient results under certain usage conditions only. Such detergents contain rinse aid and/or salt in preset amounts

### **Points to consider when using this type of products:**

- Always make sure to check the specifications of the product you will use or whether or not it is a combined product.
- Check if the detergent used is appropriate for the hardness of mains water that machine is pertaining to.
- Observe the instructions on packagings when using such products.
- If such detergents are in the form of tablets, never put them into the interior section or the cutlery basket of the dishwasher. Always put the tablets into the detergent compartment in the detergent dispenser.



- They produce good results for certain types of usage only. If you are using this type of detergents, you need to contact the manufacturers and find out about the suitable conditions of use.
- When the conditions of use of such products and the machine settings are appropriate, they ensure savings in salt and/or rinse aid consumption.
- Contact the detergent manufacturers if you are not obtaining good wash results (if your dishes stay calcareous and wet) after having used 2 in 1 or 3 in 1 detergents. The scope of warranty for your machine does not cover any complaints caused by the use of these types of detergents.

**Recommended usage:** If you want to obtain better results while using combined detergents, add salt and rinse aid into your machine and adjust the water hardness setting and the rinse aid setting to the lowest position.

**!** Solubility of the tablet detergents produced by different companies can vary depending on the temperature and time. Therefore, it is not recommended to use such detergents in short programs. It is more suitable to use powder detergents in such programs.

**Warning:** Should any problem, which you have not encountered before, arise with the use of this type of detergents, contact the detergent manufacturers directly.

#### **When you give up using combined detergents**

- Fill the salt and rinse aid compartments.
- Adjust the water hardness setting to the highest position ( 6 ) and run an empty-wash.
- Adjust the water hardness level.
- Make the suitable rinse aid setting.

#### **Filling with rinse aid and making the setting**

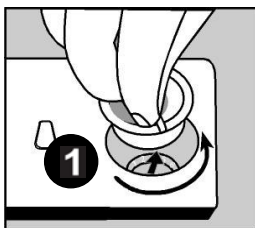

Rinse aid is used to prevent the stay of white water drops, lime stains, white film strip-shaped stains that may form on the dishes, as well as to increase the drying performance. Contrary to the popular beliefs, it is used not only for obtaining shinier dishes but also for obtaining sufficiently dried dishes. For this reason, care should be taken that there is adequate amount of rinse aid in the rinse aid compartment and only polishing material produced for use at dishwashers should be used.

If the rinse aid lamp on the control panel becomes on fill the rinse aid compartment with rinse.

To put rinse aid, remove the rinse aid compartment cap by turning it. **1** Fill the rinse aid compartment with rinse aid until the rinse aid level indicator becomes dark. **2** refit the cap and close it by turning it in a way that the nails will correspond to one another. By checking the rinse aid level indicator on the detergent dispenser, you can understand whether or not your machine needs rinse aid. A dark indicator **b** means that there is rinse aid in the compartment, while a light indicator **a** shows that you need to fill the compartment with

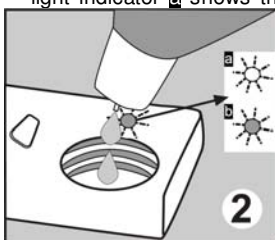

rinse aid.

The rinse aid level adjuster can be set to a position between 1 and 6. Factory setting for rinse aid is the position **3**. You need to increase the degree of the adjuster if water stains form on your dishes after a wash, whereas you need to decrease the degree if a blue stain is left when wiped by hand. **3**

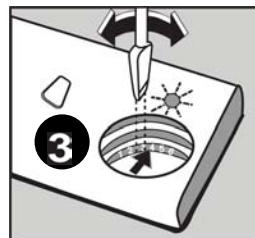

**Warning:** Use only those rinse aid materials which are allowed for use in the machine. As rinse aid residues left as a result of overflowing will create extremely high amounts of foam and thus reduce the washing performance, remove the excess amount of rinse aid by wiping it with a rag.

## LOADING YOUR DISHWASHER

If you properly place your dishes into the machine, you will be using it in the best way in terms of energy consumption, washing and drying performance.

There are two separate baskets for you to load your dishes into your machine. You can load into the lower basket such round and deep items as pots with long handles, pot lids, plates, salad plates, cutlery sets.

The upper basket has been designed for tea plates, dessert plates, salad bowls, cups and glasses. When placing long-stem glasses and goblets, lean them against the basket edge, rack or glass supporter wire and not against other items. Do not lean long glasses against one another or they cannot remain steady and may receive damage.

It is more appropriate to locate the thin narrow parts into the middle sections of baskets.

You can place spoons among the other cutlery sets in order to prevent them from sticking to one another. You are recommended to use the cutlery grid in order to obtain the best result.

To avoid any possible injuries, always place such long-handle and sharp-pointed dishes as serving fork, bread knife etc. with their sharp points facing down or horizontally on the baskets.

**Warning:** Place your dishes into your machine in a way that they will not prevent the upper and lower spray arms from spinning.

### **Top basket**

#### **Height Adjustable Rack**

These racks are designed to increase the capacity of the top basket. You can place your glasses and cups on the racks. You can adjust the height of these racks. Thanks to this feature, you can place different sizes of glasses under these racks.

Thanks to height adjustment plastics mounted on the basket, you can use your racks in 6 different heights. In addition, you can place long forks, knives and spoons on these racks laterally, so that they do not block the revolution of propeller.

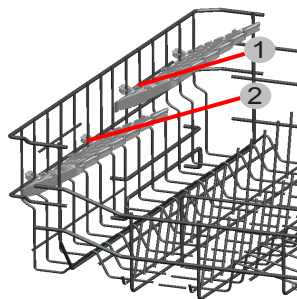

## Spoon rack

It allows your long-stemmed goblets to be washed safely as well as it is a part to provide your spoons and forks put easily to spoon rack. Do not lean your long-stemmed goblets and glasses against each other but spoon rack, thus during the washing it is ensured your glasses and goblets stay in place and a safe washing by preventing contact each other.

There are 4 different positions for your spoon rack.

According to the status of your goblets and glasses, you can set your spoon rack to the positions number 1 and 2.

Use it for your spoons and forks while it was in position 1.

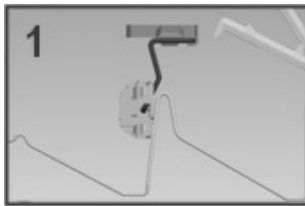
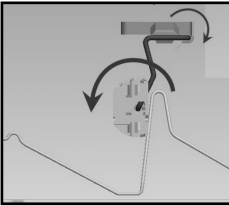
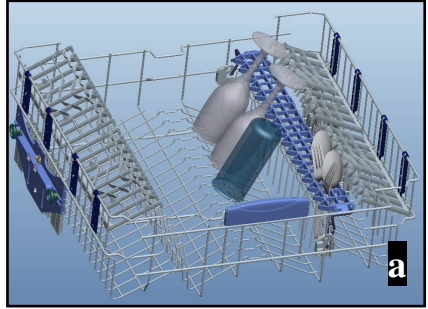

If you do not want to use spoon rack, you can bring it to the positions 3 or 4, so that you can form larger-volume areas in the upper basket **b**.

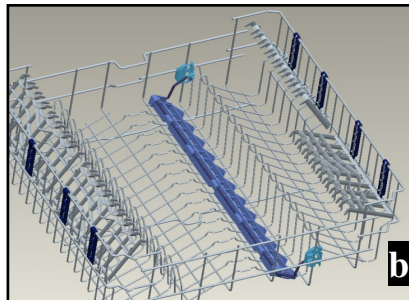
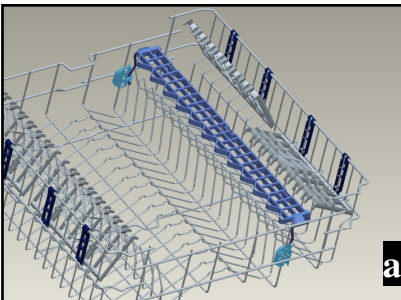
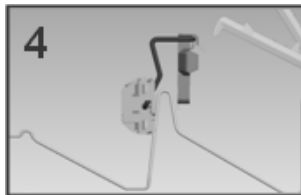
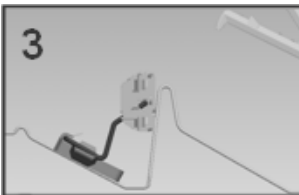

### **Top basket height adjustment while it is full**

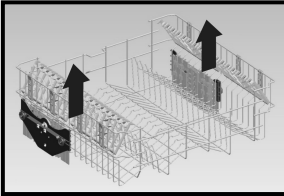

Basket height adjustment mechanism on the top basket of your machine is designed to let you adjust the height of your top basket upwards or downwards, without removing it from your machine when it is full, and create large spaces at the top or bottom area of your machine as needed. Basket of your machine is set to upper position in factory settings. In order to raise your basket, hold it from both sides and pull it upwards. In order to lower it, hold it from both sides again, and leave it.

In loaded basket adjustment mechanism, make sure that both sides are in the same position (up or down).

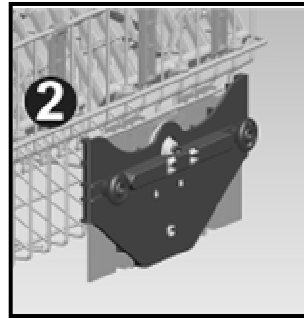
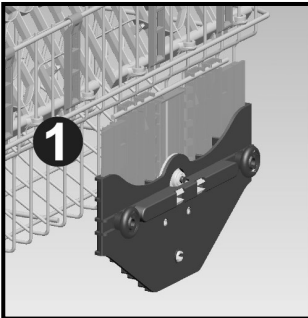

### **Lower Basket Folding Racks**

Folding racks consisting of four parts that are located on the lower basket of your machine are designed in order to let you place big items easier such as pots, pans, etc. If requested, each part can be folded separately, or all of them can be folded and larger spaces can be obtained. You can use folding racks by raising them upwards, or by folding.

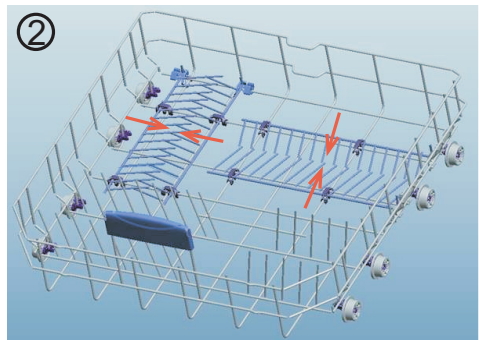
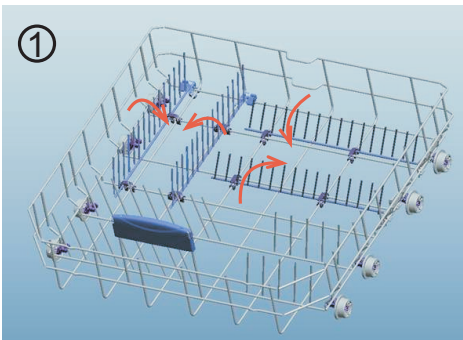

### **Modular fork spoon**

According to the number of your dirty forks, spoons and knives, you can separate your basket of modular fork and spoon into two separate parts. Hold your basket from both sides to separate it and you can separate your basket into two separate parts by moving the one side forward while moving the other side back. To combine your basket back to the same, make the inverse of the same movement.

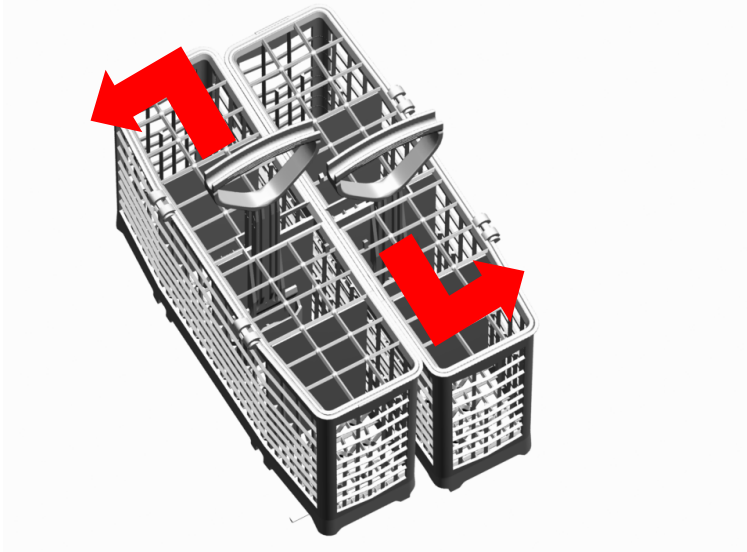

Modular basket handle has a feature of adjustable height. Once you have separated your modular basket into two parts, you can place your upper basket. Depending on the sub-top position of your upper basket, you can use handle level of the modular basket by bringing to the positions a or b.

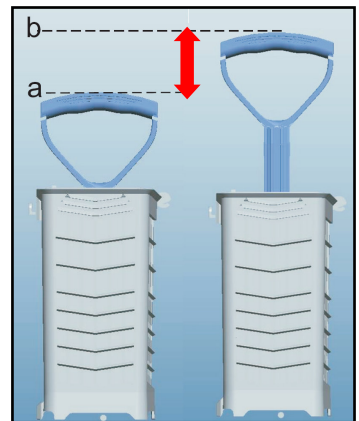

By placing your modular fork spoon basket in different places at upper or lower basket, you can form appropriate fields for your other dishes.

Below you can see several recommended settlements.

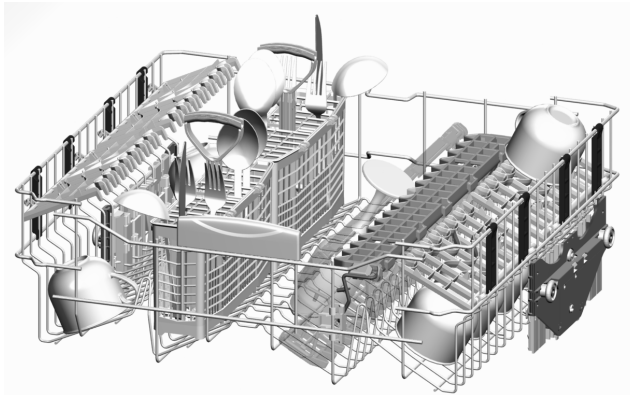
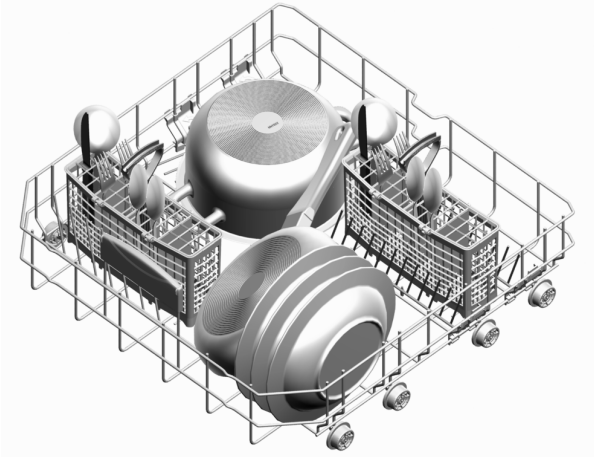

**Alternative basket loads**  
**Lower Basket**

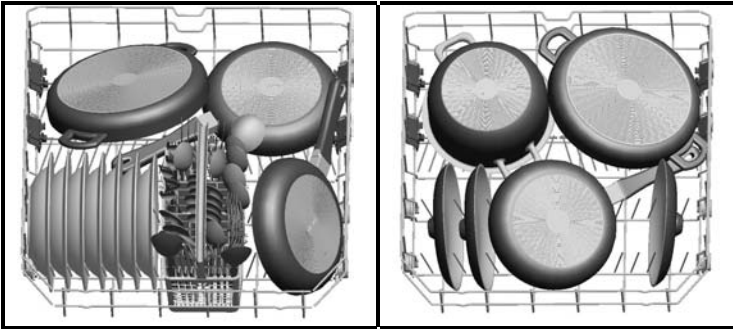

**Top Basket**

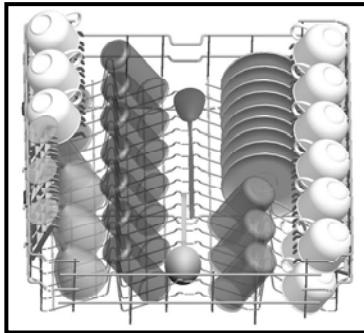

**Faulty loads**

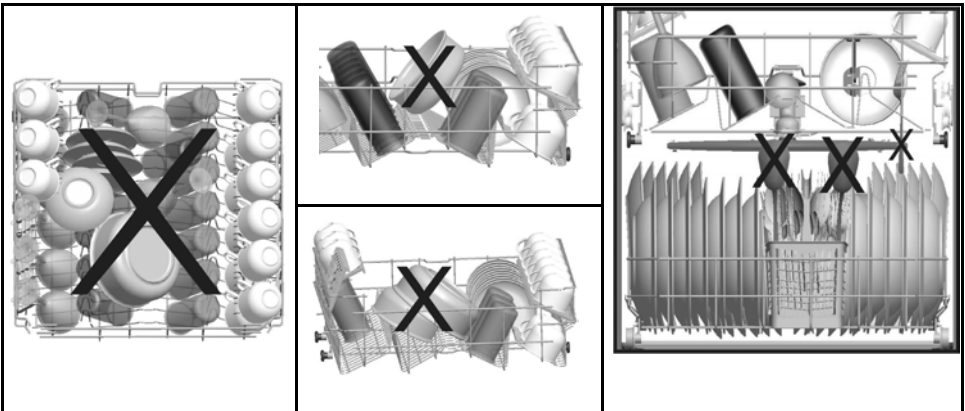

**Standard loading and test data**

**Capacity:**

Upper and lower baskets: 15 place settings. The upper basket should be adjusted to lower position  
Cups should be placed on to the dish rack pins.

**Detergent / Rinse aid**

7+28 cm<sup>3</sup>, in accordance with EN50242-DIN 44990 IEC 436 (international norms) / Rinse aid dosage adjustment: 4

**Programme test**

Economic 50 °C, in accordance with EN 50242 (international norms)

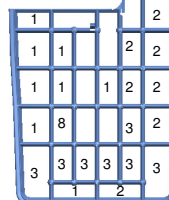
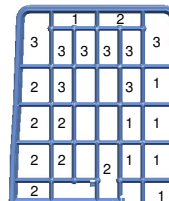
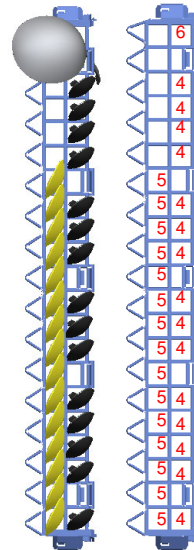
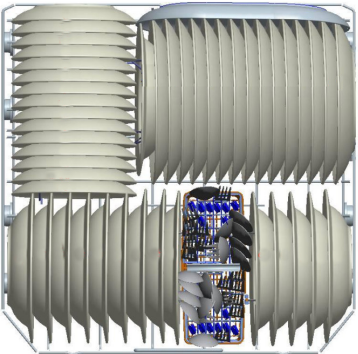
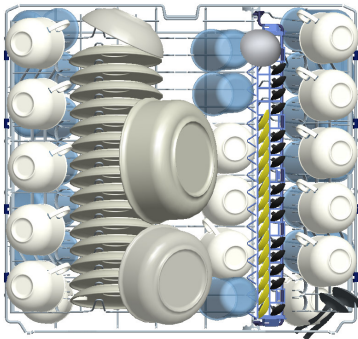



## PROGRAM DESCRIPTIONS

### Program items

Name of Program	Pre-washing	Auto Delicate	Auto Normal	Auto Intense	Quick 30 min.	Economic	Super 55 min.	Daily
Washing Temperature	-	30-50°C	50-60°C	60-70°C	40°C	50°C	60°C	60°C
Type of Food Fragment	Fresh less dirty, coffee, milk, tea	Detects contamination level of dishes and sets temperature and amount of washing water and washing period automatically			Fresh coffee, milk, tea, cold meat, vegetables	Fresh coffee, milk, tea, cold meat, vegetables	Tarried soup, sauce, pastry, egg, rice, potato and meals cooked in oven, fried food	Fresh coffee, milk, tea, cold meat, vegetables
Level of Contamination	small	small	high	high	small	Medium	Medium	Medium
Amount of Detergent A: 25 cm <sup>3</sup> / 15 cm <sup>2</sup> B: 5 cm <sup>2</sup>	B**	A	A+B	A+B	A	A+B	A+B	A+B

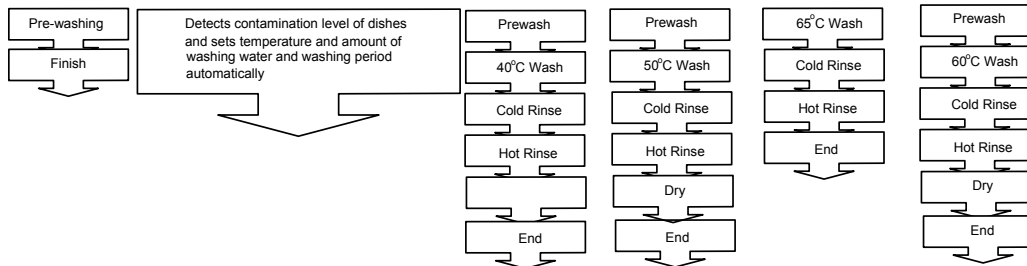

Program Period (minutes)	15	64 - 92	100 - 127	111 - 183	30	156	50	90
Power Consumption (kW hour)	0.02	0.80 - 0.99	1.13 - 1.46	1.30 - 1.95	0.88	0.95	1,31	1.38
Water Consumption (liters)	4.2	10.6 - 17.7	10.9 - 18.5	12.3 - 24.6	10.9	9.5	10.7	14.4

In case option of ½ Half-load is used, the values in the program list will be as follows.

Program + ½ load	Pre-washing	Auto Delicate 30-50°C	Auto Normal 50-60°C	Auto Intense 60-70°C	Quick 30 min. 40°C	Economic	Super 55 min. 60°C	Daily 60°C
Program Period (minutes)	15	62 - 81	100 - 127	113 - 163	30	144	42	78
Power Consumption (kW hour)	0.02	0.77 - 0.96	1.10 - 1.43	1.27 - 1.92	0.88	0.93	1,31	1.35
Water Consumption (liters)	4.2	9,9 -13,7	10.9 - 18.5	11.3 -19,9	10,9	9.5	10.7	11.1

\*\* Only powder detergent should be used in cycle of prewash programme.

**Warning:** Short programs do not include a drying step.

The values declared above are the values obtained under laboratory conditions according to relevant standards. These values can change depending on conditions of product's use and environment (network tension, water pressure, water input temperature and environment temperature).

# SWITCHING ON THE MACHINE AND SELECTING A PROGRAMME

## Switching on the machine

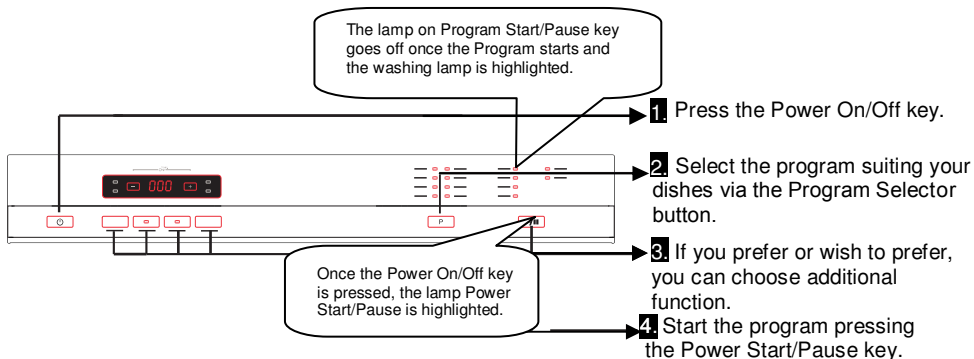

## Program follow-up

You can follow the program flow using the program follow-up lamps located on the control panel.

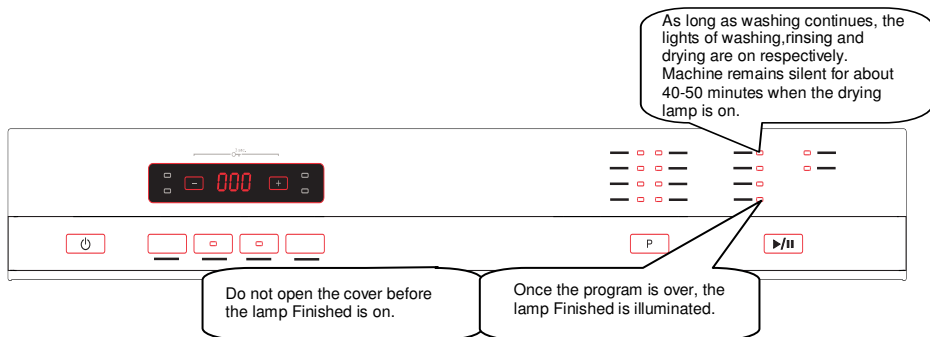

## Changing a programme

If you would like to change programs while a washing program is continuing.

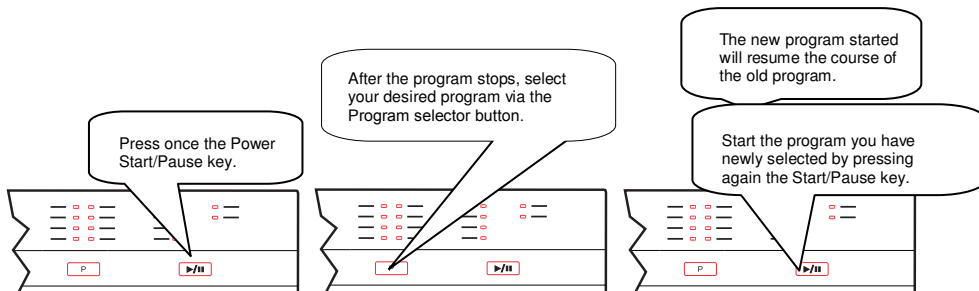

### Changing a programme with resetting

If you would like to cancel a program while a washing program is resumed.

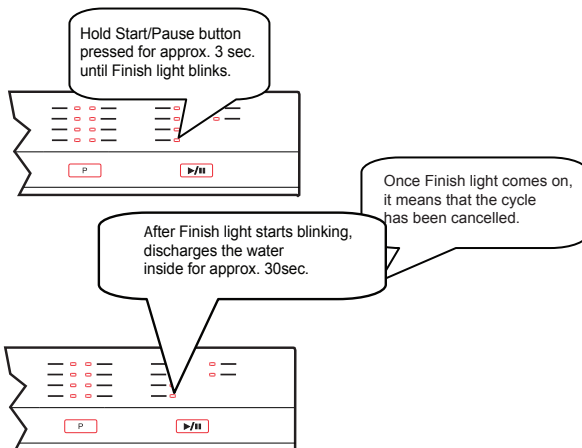

### Switching the machine off

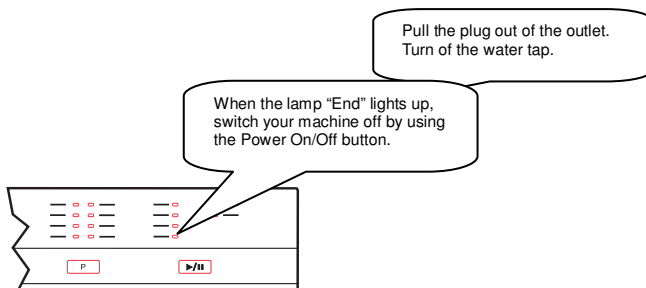

**Note:** You can slightly open the door in order for the machine to perform a faster dry operation after the wash programme is finished.

**Note:** If the machine door opens during washing or the power is cut off, the machine will go on to the program in case the door is shut or the power is back.

## MAINTENANCE AND CLEANING

**Cleaning the machine in regular intervals prolongs the machine's service life.**

**Oil and lime may accumulate in the machine's washing section. In case of such accumulation;**

-Fill the detergent compartment without loading any dishes into the machine, select a programme that runs at high temperature, and start the machine. In case of insufficiency, use special cleansing material available in the market. (Cleansing material produced special to machines by detergent producers.)

**Cleaning the seals in the machine door,**

-To clean any accumulated residues in the door seals, wipe the seals regularly by using a dampened cloth.

**Cleaning the machine,**

Clean the filters and spray arms at least once a week.

Unplug your machine and turn off its tap before starting the cleaning.

Do not use hard materials when cleaning your machine. Wipe with a fine cleaning material and a dampened cloth.

### Filters

Check if any food wastes have remained on the coarse and fine filters. If any food wastes are left, remove the filters and clean them thoroughly under the water tap.

- a. Micro Filter
- b. Coarse Filter
- c. Metal/Plastic Filter

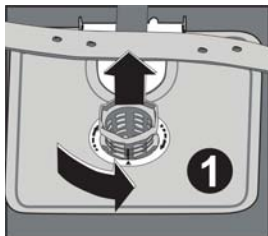

To remove and clean the filter combination, turn it counter clockwise and take it out by lifting upwards. **1**

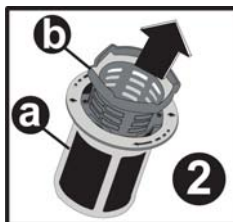

Pull and remove the metal/plastic filter. **3** Then pull the coarse filter out of the micro filter. **2** Rinse it with lots of water under the tap. Refit the metal/plastic filter. Insert the coarse filter into the micro filter in a way that the marks will correspond to one another. Attach micro filter into the metal/plastic filter and turn to the direction of arrow and it is locked when the direction of arrow on micro filter can be seen from across. **4**

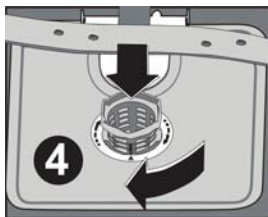
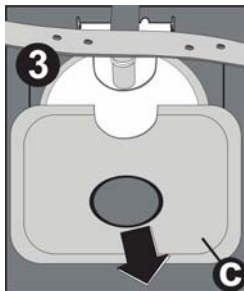

- Never use your dishwasher without any filter.
- Incorrect fitting of the filter will reduce the washing effectiveness.
- Clean filters are very important in terms of the proper running of the machine.

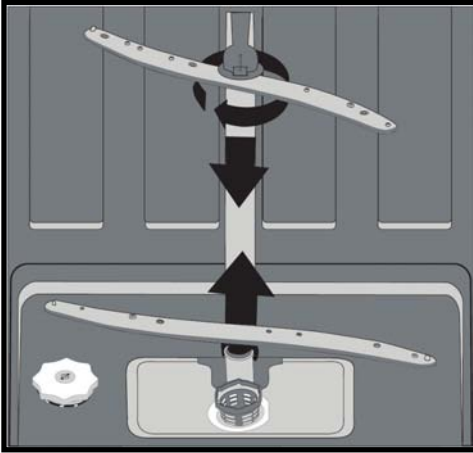

### **Spray arms**

Check whether or not the holes for the upper and lower spray arms are clogged. If there is any clogging, remove the spray arms and clean them under water.

You can remove the lower spray arm by pulling it upwards, while the upper spray arm nut can be removed by turning the nut to the left.

Be sure that the nut is perfectly tightened when refitting the upper spray arm.

### **Hose filter**

Water is prevented by the inlet hose filter so as to avoid any damage to your machine because of any contamination (sand, clay, rust etc.) that might be occasionally carried in through the mains water supply or the indoor plumbing, and to forestall such complaints as yellowing and formation of deposits after washing. Check the filter and the hose from time to time and clean them if necessary. To clean the filter, first turn off your tap and then remove the hose. After removing the filter from the hose, clean it under the tap. Insert the cleaned filter back into its place inside the hose. Refit the hose.

## FAILURE CODES AND WHAT TO DO IN CASE OF FAILURE

ERROR CODE	ERROR DESCRIPTION	CONTROL
F5	Inadequate water supply	<ul style="list-style-type: none"> <li>• Make sure the water input tap is totally open and that there is no water cut.</li> <li>• Close the water input tap, separate the water input hose from the tap and clean the filter at the connection end of the hose.</li> <li>• Restart your machine, contact the service if the error resumes.</li> </ul>
F3	Error of continuous water input	<ul style="list-style-type: none"> <li>• Close the tap.</li> <li>• Contact the service.</li> </ul>
F2	The waste water in the machine cannot be discharged.	<ul style="list-style-type: none"> <li>• Water discharge hose is clogged.</li> <li>• The filters of your machine might be clogged.</li> <li>• Power off-on your machine and activate the program cancellation command.</li> <li>• If the error continues, contact the service.</li> </ul>
F8	Heater error	Contact the service.
F1	Alarm is active against water overflow	<ul style="list-style-type: none"> <li>• Power off your machine and close the tap.</li> <li>• Contact the service.</li> </ul>
FE	Faulty electronic card	Contact the service.
F7	Overheating error (temperature in the machine is too high)	Contact the service.
F9	Divisor position error	Contact the service.
F6	Faulty heater sensor	Contact the service.

***If one of program monitor lights is on and start/Pause light is on and off,***

Your machine's door is open, shut the door.

***If the programme won't start***

- Check if the plug is connected.
- Check your indoor fuses.
- Be sure that the water inlet tap is turned on.
- Be sure that you have closed the machine door.
- Be sure that you switched off the machine by pressing the Power On / Off button.
- Be sure that the water inlet filter and the machine filters are not clogged.

***If the control lamps won't go out after a wash operation***

The *Power On/Off* button is released yet.

***If detergent residues are left in the detergent compartment***

Detergent has been added when the detergent compartment was wet.

***If water is left inside the machine at the end of the programme***

- The water drain hose is clogged or twisted.
- The filters are clogged.
- The programme is not finished yet.

***If the machine stops during a wash operation***

- Power failure.
- Water inlet failure.
- Program can be on standby mode.

***If shaking and hitting noises are heard during a wash operation***

- Dishes placed incorrectly.
- Spray arm hitting the dishes.

***If there are partial food wastes left on the dishes***

- Dishes placed incorrectly into the machine, sprayed water did not reach related places.
- Basket overly loaded.
- Dishes leaning against one another.
- Very small amount of detergent added.
- An unsuitable, rather weak wash programme selected.
- Spray arm clogged with food wastes.
- Filters clogged.
- Filters incorrectly fitted.
- Water drain pump clogged.

***If there are whitish stains on the dishes***

- A very small amount of detergent is being used.
- Rinse aid dosage setting at a very low level.
- No special salt is being used despite the high degree of water hardness.
- Water softener system setting is at a very low level.
- Salt compartment cap not closed well.

***If the dishes won't dry up***

- A programme without a dry operation selected.
- Rinse aid dosage set too low
- Dishes unloaded too fast.

***If there are rust stains on the dishes***

- Stainless-steel quality of the dishes washed is insufficient.
- High rate of salt in the wash water.
- Salt compartment cap not closed well.
- Too much salt spilt into the sides and into the machine while filling it with salt.
- Unhealthy mains grounding.

**Call an authorised service if the problem still persists after the controls or in case of any malfunction not described above.**

## ***PRACTICAL AND USEFUL INFORMATION***

**1.** Whenever you will not be operating your machine

- Unplug the machine and then turn the water off.
- Leave the door slightly ajar in order to prevent the formation of unpleasant smells.
- Keep the machine interior clean.

**2.** Eliminating water droplets

- Wash the dishes with the intensive programme.
- Take all of the metal containers in the machine out.
- Do not add detergent.

**3.** If you properly place your dishes into the machine, you will be using it in the best way in terms of energy consumption, washing and drying performance.

**4.** Clean all rough waste before you place dirty dishes to the machine.

**5.** Operate the machine after it is completely full.

**6.** Use pre-washing program only when necessary.

**7.** Observe program information and average consumption values table when selecting a program.

**8.** Since the machine will reach high temperatures, it should not be mounted near refrigerator.

**9.** If the appliance is located in a place where the risk of freezing exists, you must completely drain the water that has remained in the machine. Turn off the water tap, disconnect the water inlet hose from the tap and allow the interior water to drain.



## THE PRODUCT FICHE (Spect)

Supplier's trade mark	PELGRIM
Supplier's model	PVW6030WIT/P01
Capacity of dishwasher	15
The energy efficiency class	A+
Annual energy consumption in kWh per year (AE <sub>c</sub> ) ( 280 Cycle ) *	282
Energy consumption (E <sub>i</sub> ) (kWh per cycle)	0,98
Off-mode power consumption (W) (P <sub>o</sub> )	0,05
Left-on mode power consumption (W) (P <sub>i</sub> )	1
Annual water consumption in litres per year (AW <sub>c</sub> ) ( 280 Cycle ) **	2520
Drying efficiency class ***	A
Standard programme name ****	Eco 50 °C
Programme time for standard cycle ( min)	156
Noise dB(A)	45

\* Energy consumption **282** kwh per year, based on 280 standard cleaning cycles using cold water fill and the consumption of low power modes. Actual energy consumption will depend on how the appliance is used.

\*\* Water consumption **2520** liters per year based on 280 standard cleaning cycles. Actual water consumption will depend on how appliance is used.

\*\*\*Drying efficiency class **A** on a scale from G(least efficient) to A (most efficient).

\*\*\*\* The "**Eco 50 °C**" is the standard cleaning cycle to which the information in the label and the fiche relates. This programme is suitable to clean normally soiled tableware and it is the most efficient programme in terms of combined energy and water consumption.