



PKS4178K

PKS5088K

PKD5088K

PKS5102K

PKD5102K

PKS5122K

PKD5122K

## Instructions for use fridge

---

**Pelgrim**

# Refrigerator

Thank you for your confidence in buying our appliance and congratulations on the excellent choice. We hope it will successfully serve its purpose for many years.

**The appliance is intended solely for household use.**

**Refrigerator** (hereinafter: the appliance) is used in households for storage of fresh food at temperatures above 0°C.

<b>Before first operation .....</b>	<b>3</b>
<b>A few tips on how to save power with your refrigerator-freezer combo .....</b>	<b>4</b>
<b>Description of the appliance .....</b>	<b>5</b>
<b>Installation and connections .....</b>	<b>6</b>
<b>Changing the Direction of Opening the Door .....</b>	<b>8</b>
<b>Appliance with mechanic control .....</b>	<b>9</b>
<b>Refrigerator accessories .....</b>	<b>10</b>
<b>Storage of food in the refrigerator .....</b>	<b>11</b>
<b>Defrosting the appliance.....</b>	<b>12</b>
<b>Cleaning the appliance .....</b>	<b>13</b>
<b>Troubleshooting guide.....</b>	<b>14</b>
<b>Noise level.....</b>	<b>15</b>

## Before first operation

- This appliance can be used by children aged from 8 years and above and persons with reduced physical, sensory or mental capabilities or lack of experience and knowledge if they have been given supervision or instruction concerning use of the appliance in a safe way and understand the hazards involved. Children shall not play with the appliance. Cleaning and user maintenance shall not be made by children without supervision.
- Before connecting the appliance read these instructions carefully. They describe the appliance and provide instructions for its safe and correct use. The instructions are prepared for different types and models of the appliance so they may contain descriptions of functions and components your appliance may not have.
- Remove the wrapping protecting the appliance during transport.
- Wrappings contain environmentally friendly materials which can be recycled, recovered or disposed off without threat to the environment.
- On the door corners (on freestanding appliances) or on the housing of the appliances (on built-in appliances) the spacers are installed, which should be removed and replaced with the attached spacer-plugs.
- Before connecting the appliance to the mains supply, leave it in upright position for about 2 hours. This will reduce possibility of malfunctions in the cooling system resulting from prior transport and handling.
- The appliance must be connected to the mains supply in accordance with the standing regulations and local requirements.
- The appliance must not be used in open air or exposed to weather precipitation.
- Always disconnect the appliance from power supply (pull the power cord from wall socket) before cleaning and before replacing the light bulb.
- If the power supply cord is damaged, in order to avoid hazard it must be replaced by the service or by qualified personnel.
- In case of longer disuse first turn the appliance off with the ON/OFF button and disconnect it from mains supply. Empty the appliance, clean the interior and leave the door ajar.
- For the protection of environment deliver the obsolete appliance to the authorized scrap appliance dealers.
- Never let the children play with the appliance.
- Self closing shear door hinge pulls the door to the cabinet just before closing, thereby preventing the door to remain ajar. Equally it limits the door opening angle and prevents damage to adjacent elements.
- Rating plate with basic information is located in the interior of the appliance. If the sticker plate is not suitable for your language, replace it with the attached one.
- **Warning:** Ventilation slots on the appliance or built-in element should always be kept clean and unobstructed.
- **Warning:** Do not use any mechanical accessories when thawing the refrigerator, except for those explicitly recommended by the manufacturer.

- **Warning:** To prevent any pollution be careful not to damage the insulation or refrigeration tubes at the rear wall during the installation, cleaning and disposal of the appliance.
- **Warning:** Do not use any electrical devices inside the appliance, except for those explicitly recommended by the manufacturer.



The symbol on the product or on its packaging indicates that this product may not be treated as household waste. Instead it shall be handed over to the applicable collection point for the recycling of electrical and electronic equipment. By ensuring this product is disposed of correctly, you will help prevent potential negative consequences for the environment and human health, which could otherwise be caused by inappropriate waste handling of this product. For more detailed information about recycling of this product, please contact your local city office, your household waste disposal service or the shop where you purchased the product.

## A few tips on how to save power with your refrigerator-freezer combo

- Observe the installation instructions.
- Do not open the appliance door more frequently than necessary.
- Occasionally check whether air can circulate freely behind the appliance.
- Condenser unit mounted on the appliance back wall must be kept clean at all times (see section "Cleaning the appliance").
- If the seal is damaged or loose, replace it as soon as possible.
- Store your food in closed containers or other appropriate packaging.
- Before placing the food in the refrigerator, let it cool down to room temperature.
- Defrost your frozen food in the refrigerator compartment.
- Remove the freezer drawers and door as described in the instructions, in order to make use of the entire capacity.
- Defrost your conventional freezer when a frost layer approximately 3-5 millimetres thick has accumulated on the surfaces in the freezer compartment.
- Make sure the shelves are evenly distributed and that the food is arranged in a way that allows free circulation of air (heed the recommended food arrangement as described in the instructions).
- In appliances fitted with a fan, do not block the fan slots.

# Description of the appliance

Interior equipment of the appliance will typically vary according to the specific model.

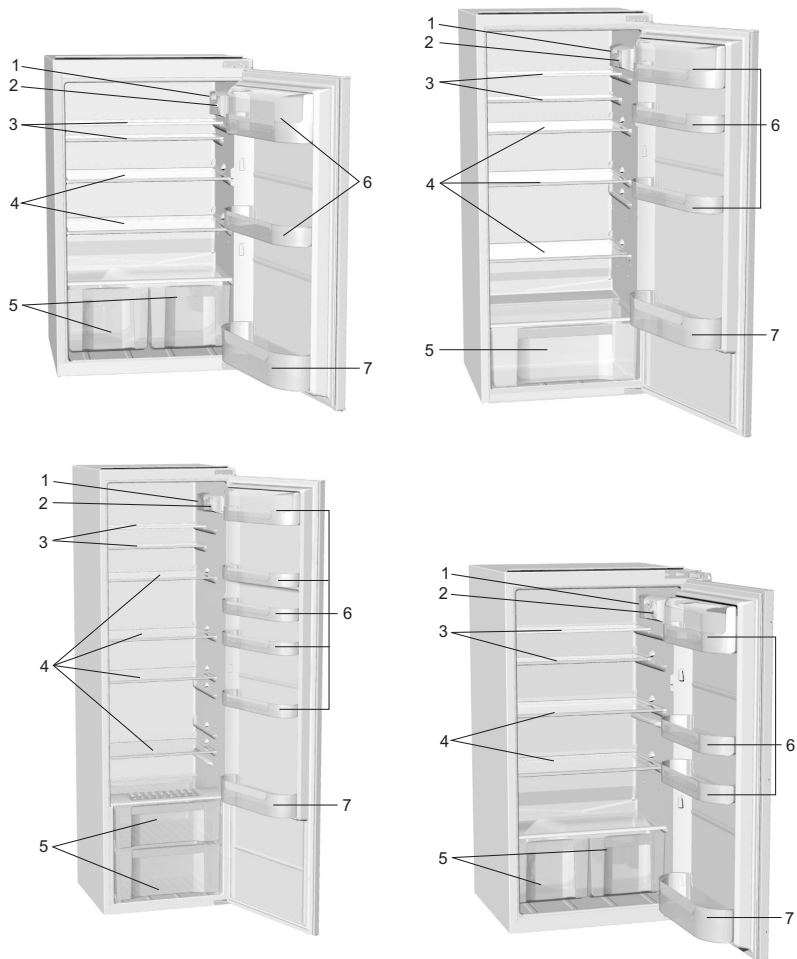

- 1 Interior light
- 2 Control panel
- 3 Adjustable glass shelves
- 4 Pull-out glass shelf (adjustable height)

- 5 Storage compartment
- 6 Refrigerator door pans (options: deep, shallow; covered or no cover)
- 7 Door bottle rack

# Installation and connections

## Selecting the location

- Place the appliance in dry and well aired room. The appliance operates best at temperature ranges indicated in the chart below. Relevant class of the appliance is indicated on the rating plate.

Class	Ambient temperature
SN (subnormal)	from + 10°C to + 32°C
N (normal)	from + 16°C to + 32°C
ST (subtropical)	from + 16°C to + 38°C
T (tropical)	from + 16°C to + 43°C

## Positioning the appliance

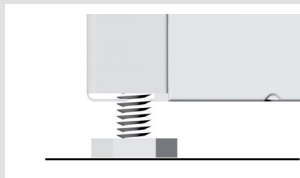

Positioning the appliance requires two persons in order to avoid injuries or damage to the appliance.

- Place the appliance flatly and firmly on a solid base. The appliance is fitted with adjustable feet on the front side, used to level the appliance (certain models only).
- Avoid exposing the appliance to direct sunlight or heat sources. If this is not feasible, install insulation plate between the appliance and adjacent heat source.
- The appliance may stand independently or you may incorporate it into the kitchen cabinet. Be sure to leave enough space for cooling of condenser (distance from the wall or the opening should be 200 cm<sup>2</sup>). Distance to the cabinet above the appliance should be at least 5 cm.  
After the installation, the appliance mains plug should be accessible!

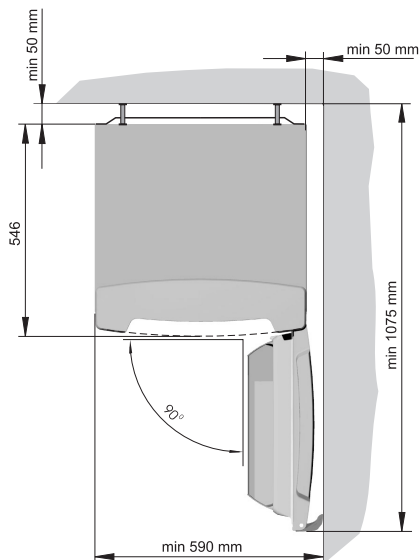

### **Connecting to power supply**

- The appliance is fitted with spacers to be mounted on the top edge of the condenser. They prevent the rear of the appliance to be pushed too close to the wall. Spacers are fabricated universally regarding the different distance of the condenser from the cabinet, so make sure to position them properly.
- Use the power cord to connect the appliance to the mains power. Wall outlet must be fitted with ground terminal (safety socket). Required nominal voltage and frequency are indicated on the relevant label or rating plate of the appliance.
- Mains power connection and grounding must be made in line with standing regulations and local requirements.

The appliance is able to accommodate minor temporary voltage tolerances, but they may not exceed -6% to +6%.

# Changing the Direction of Opening the Door

**Freestanding appliance**

**Necessary tools: ring spanner No.8, screwdriver, torque 25**

Tilt the appliance so that the bottom hinge can be unscrewed and proceed with disassembling as shown in the Figure 3. Then fix the assembly parts again in the opposite turn. Use the attached opposite hinge insert piece. The door should be ajar before the middle (upper) hinge is attached. Use the bungs, which have been pulled out, on the opposite side. Check the door seal. In case that it does not rest well, take it off and turn it by 180°.

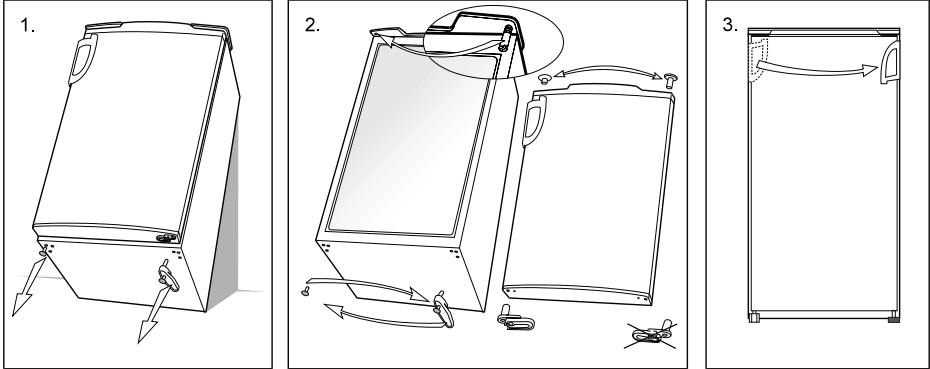



# Appliance with mechanic control

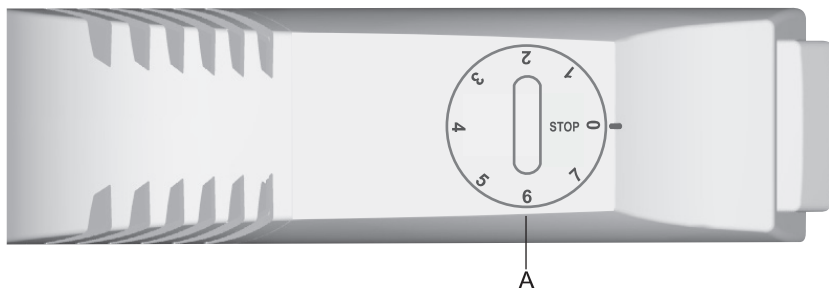

## A Temperature setting and on/off knob

### Turning the appliance on/off

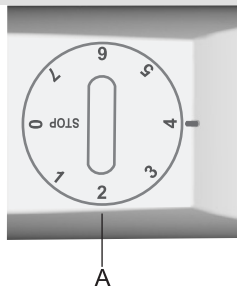

**Turn on:** rotate the thermostat knob clockwise towards position 7.

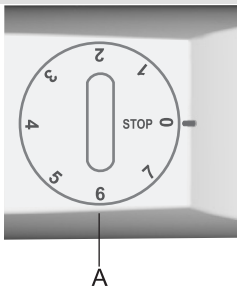

**Turn off:** rotate the knob back to position **STOP (0)**.

### Setting the temperature

- When the environment temperature is normal, a medium setting is recommended. You can set higher or lower temperature according to your wish by setting the thermostat knob.
- Settings towards position 7, selected with the knob, correspond to lower (cooler) temperatures. The temperature in the refrigerator interior may drop below 0°C. Settings towards position 1 mean higher temperatures (warmer). Only use settings towards position 7 when a lower temperature is desired and recommended or when environment temperature is lower than 16°C.
- A change in the environment temperature affects the temperature in the appliance. Hence, the thermostat setting should be adjusted accordingly.
- When the thermostat knob is set to position STOP (0), the appliance will not operate (cooling system is off); however, the appliance is still powered (a light will illuminate the interior when the refrigerator door is opened).

# Refrigerator accessories

(Equipment depends on the model)

## Shelf

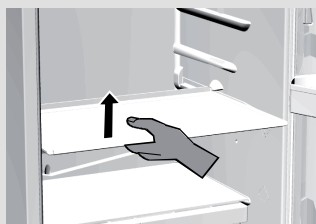

- Shelves can be optionally placed on the guides inside the appliance. To remove the shelf, first slide it out as far as the guide allows it, then slightly lift it up and pull it out. Quickly perishable food should be stored on the back i.e. the coldest part of the shelves.

## Adjustable glass shelf

If you need space to store higher objects (bottles, jars, jugs) in the refrigerator you can remove the front part of the shelf, relocate it to a lower level, and obtain the required space.

## Vegetable crisp pan

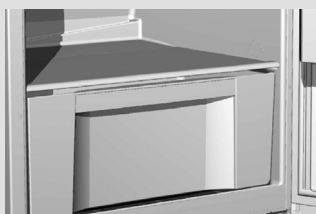

- Crisp tray below the glass shelf at the bottom of the refrigerator is used for storage of fruit and vegetables. It retains the right level of moisture and prevents drying out.

## Refrigerator door lining

- The refrigerator door lining consists of various shelves or holders used for storing cheese, butter, eggs, yogurt, and a stock of other smaller packages, tubes, cans etc. The bottom shelf is used for storing bottles.

## Recommended distribution of food

### Refrigerator compartments:

- **top section:** canned food, bread, wine, cake, etc.
- **middle section:** dairy products, readymade food, desserts, juices, beer, TV-dinners, etc.
- **bottom section:** meat, meat products, delicatessen, etc.
- **vegetable drawer:** fresh fruit, vegetables, salads, root vegetables, potatoes, onions, garlic, tomatoes, tropical fruit, sauerkraut, turnip, etc.

### Refrigerator door lining compartments:

- **top/middle section:** eggs, butter, cheese, ...
- **bottom section:** beverages, cans, bottles, ...

# Storage of food in the refrigerator

## ***Important precautions and hints***

- Proper use of the appliance, adequately packed food, correct temperature and hygienic precautions produce substantial impact on the quality of stored food.
- Always respect the best before date, printed on the packaging.
- Food to be stored in the refrigerator should be properly packed as to prevent emission and/or reception of moisture and odors.
- Never store inflammable, volatile or explosive substances.
- Beverages with high alcohol percentage shall be stored in tightly sealed bottles in vertical position.
- Some organic solutions like volatile oils in lemon or orange peel, acids in butter etc. can cause damage in prolonged contact with plastic surfaces or gaskets for longer period of time they can cause accelerated aging of the plastic material.
- Unpleasant odor inside the refrigerator is a sign that something is wrong with food or that your refrigerator needs cleaning (see chapter Cleaning).
- If you plan a longer absence, make sure you removed quickly perishable articles of food from the appliance before you leave.

## ***Storage periods***

### **Recommended periods of storing fresh food in the refrigerator**

<b>Food</b>	<b>Storage period</b>
eggs, marinades, smoked meat,	up to 10 days
cheese	up to 10 days
carrots, etc...	up to 8 days
butter	up to 7 days
cake, fruit, TV-dinner dishes, raw chunks of meat	up to 2 days
fish, raw minced meat, seafood	up to 1 day

## Defrosting the appliance

### ***Automatic defrosting of the refrigerator***

Refrigerator needs no special defrosting procedure, because ice deposited at the inner back wall is defrosted automatically. Ice deposited on the inner back wall during the compressor operation is defrosted when the compressor stops operating, and condensed water drops are drained through the outlet in the inner back wall into the drain pan situated above the compressor where it evaporates. In case you should notice excessive ice formation at the rear refrigerator panel (3-5 mm thick), switch the appliance off and thaw it manually.

## Cleaning the appliance

**Prior any cleaning attempt disconnect the appliance from the mains** (see the control chapter for ON/OFF function), and pull the power cord from the mains wall outlet.

Make sure to remove traces of any cleansing agents you had been using.

- Clean the **exterior** of the appliance with water and liquid detergent.
- Do not use abrasive or aggressive agents (such as stainless steel cleansers) for cleaning of plastic and coated surfaces as you can damage them.
- Clean **coated and/or aluminum surfaces** with soft cloth and alcohol based cleansing agent (for example glass cleaners).
- Wash the **interior** of the appliance with liquid detergent and lukewarm water, mixed with a little vinegar.
- Containers, shelves, and drawers with a decorative profile (metallic appearance) are not dishwasher safe! They can only be cleaned with a dissolved liquid detergent and a soft cloth. Do not rub them!

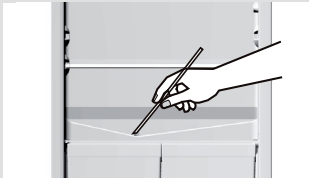

- Groove and drain outlet located underneath the cooling panel at the rear wall collect the drained water, so they must not be clogged (with food particles, for example). Make sure you inspect them periodically and clean if necessary (use plastic straw to free the outlet hole).

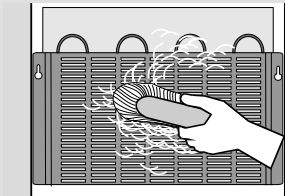

- The **condenser** on the rear wall must always be clean and free of dust or kitchen fumes deposits, therefore clean the dust periodically with non-metallic brush or vacuum cleaner..

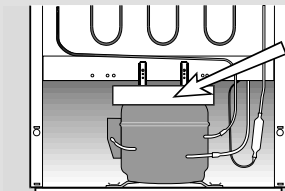

- Clean also the **drip pan** above the compressor. If you removed the pan, please make sure you replace it to the same position, and check that it is in completely horizontal position!
- Ice and/or frost deposits exceeding 3-5 mm increase energy consumption, so you need to remove them regularly. Do not use sharp pointed objects, solvents or sprays.
- After cleaning switch the appliance on and reload the food.

## Troubleshooting guide

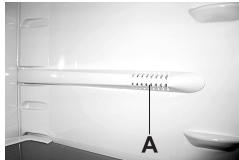
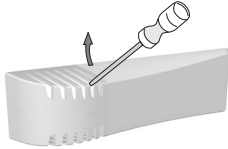
Fault:	Cause/Remedy
<p>The appliance does not operate after connection to the mains:</p>	<ul style="list-style-type: none"> <li>• Check if there is power in the socket and if the appliance is switched on.</li> </ul>
<p>Cooling system operates continuously without intermittent stoppages:</p> 	<ul style="list-style-type: none"> <li>• Ambient temperature too high.</li> <li>• Frequent opening of the door, door open too long.</li> <li>• Door not closed properly (particle between door gasket, sagged door, check gasket sealing, etc...).</li> <li>• Excessive quantity of fresh food inserted at once.</li> <li>• Refrigerator probe (A) is clogged with fresh food. Relocate the food to provide air circulation around the probe (certain models only).</li> <li>• Check air circulation for sufficient cooling of the compressor, and clean the condenser.</li> </ul>
<p>Excessive ice formation at the rear interior wall of the freezer:</p>	<ul style="list-style-type: none"> <li>• Frequent opening of the door, door open too long.</li> <li>• Inserting hot food in the freezer.</li> <li>• Food or dish is touching the rear interior panel of the refrigerator.</li> <li>• Bad door sealing; clean or replace the gasket if dirty or damaged.</li> </ul>
<p>Water dripping from the appliance:</p>	<ul style="list-style-type: none"> <li>• Drain outlet is clogged, drain water drips past the collection groove.</li> <li>• Clean the clogged outlet using plastic straw.</li> <li>• Thaw thick ice deposits manually (see chapter Defrosting).</li> </ul>
<p>Bulb replacement:</p> 	<ul style="list-style-type: none"> <li>• Before replacing the light bulb, disconnect the appliance from the power supply (pull the power cord from the wall socket). Insert the screwdriver into the cover slot, lift it and remove the cover.</li> <li>Replace the bulb with the equivalent new bulb (E 14, same voltage as the original one) and replace the cover back to its position.</li> <li>• Don't forget: the old bulb does not belong to organic waste.</li> <li>• Light bulb is consumption material and is not covered by the warranty!</li> <li>• Bulb lamps used in this appliance are special purpose lamps selected for household appliances use only. They are not suitable for household room illumination.</li> </ul>

If none of the above reasons seems to match your problem, please contact the nearest service center and state the type, model and serial number as indicated on the label with basic information attached in the appliance interior.

The refrigerator – freezer appliances are cooled by the refrigeration system with a compressor (assisted by fan in certain models) whose operation may produce certain noise. The level of such noise depends upon the location, correct use and age of the appliance.

- **After starting the appliance**, the operation of the compressor (the refrigerant flow) may be somewhat louder. This does not mean that something is wrong with the appliance, neither has it any influence on the lifetime of the appliance. Gradually the noise is reduced and eventually subsides.
- Sometimes the appliance produces **unusual and stronger noise** which is rather unusual for the appliance. This noise is often the consequence of inadequate positioning of the appliance:
  - The appliance should be placed and leveled firmly on solid base.
  - It should not touch the wall or adjacent kitchen units standing next to it.
  - Check whether the accessories in the interior of the appliance are placed correctly in their positions; also check the bottles, tins and other vessels that might touch each other and rattle.

### Declaration of conformity

 We declare that our products meet the applicable European Directives, Decisions and Regulations and the requirements listed in the standards referenced.

THE MANUFACTURER RESERVES THE RIGHT TO ALTER THE SPECIFICATIONS WITH NO IMPACT TO THE FUNCTIONAL OPERATION OF THE APPLIANCE.

# Pelgrim

COOLER 54-2 MEH PEL



362471

en (10-14)

700004235003