



PCS23178L

PCS24178L

PCD23178L

Instructions for use
Built-in refrigerator-freezer

Pelgrim

We thank you for the confidence you have shown by purchasing our appliance which is designed to simplify your life. To make the use of the product easier, we have supplied detailed instructions for use, and installation instructions supplied on a separate sheet. The instructions should allow you to learn about your new appliance as quickly as possible.

We wish you find a lot of pleasure in its use.

The appliance is intended solely for household use.

The refrigerator is intended for storing fresh food at temperatures above 0°C. **The freezer** is intended for freezing fresh food and for long-term storage of frozen food (up to one year, depending on the type of food).

Please visit our website where you can enter your appliance model number, indicated on the rating plate or the warranty sheet, to find detailed description of your appliance, tips on use, troubleshooting, service information, instructions for use etc.



www.pelgrim.nl



Important safety warning



General warnings and tips



Protecting the environment



Do not wash in the dishwasher

CONTENTS

4 IMPORTANT NOTES AND PRECAUTIONS 4 BEFORE USING THE APPLIANCE FOR THE FIRST TIME 5 IMPORTANT SAFETY INSTRUCTIONS 8 IMPORTANT INFORMATION ON THE USE OF APPLIANCE 9 ENVIRONMENT PROTECTION 10 ADVICE FOR SAVING ENERGY WITH REFRIGERATION APPLIANCES	INTRODUCTION
11 INSTALLATION AND CONNECTION 13 APPLIANCE DESCRIPTION 14 OPERATING THE APPLIANCE 16 APPLIANCE INTERIOR EQUIPMENT	APPLIANCE DESCRIPTION
20 STORING AND FREEZING FOOD	STORING AND FREEZING FOOD
24 DEFROSTING THE APPLIANCE 25 CLEANING THE APPLIANCE	DEFROSTING AND CLEANING THE APPLIANCE
26 TROUBLESHOOTING	MISCELLANEOUS

IMPORTANT NOTES AND PRECAUTIONS

BEFORE USING THE APPLIANCE FOR THE FIRST TIME

Before connecting the appliance to the power mains, please read carefully the instructions for use which describe the appliance and its correct and safe use. The instructions apply to several appliance types/models; thus, settings or equipment may be described herein which is not available in your appliance. We recommend saving this instruction manual for future reference and attach it to the appliance if it is sold in the future.

Check for any damage or irregularities on your appliance. If you find your appliance is damaged, notify the retailer from which you have purchased the appliance.

Before connecting the appliance to the power mains, let the appliance rest in a vertical position for a minimum of 2 hours. This will reduce the possibility of operation faults due to the effect of transport on the cooling system.



IMPORTANT SAFETY INSTRUCTIONS



WARNING! Risk of fire/flammable materials.

The appliance must be connected to the power mains and grounded in compliance with the effective standards and regulations.

WARNING! Do not locate multiple portable socket-outlets or portable power supplies at the rear of the appliance.

Before cleaning the appliance, unplug it from the power mains (unplug the power cord from the wall outlet).

WARNING! If the supply cord is damaged, it must be replaced by the manufacturer, its service agent or similarly qualified persons in order to avoid a hazard.

WARNING! When positioning the appliance, ensure the supply cord is not trapped or damaged.

If LED lighting does not work, call a service technician. Do not attempt a repair of the LED lighting yourself, as there is danger of contact with high voltage!



WARNING! Do not use any electric devices inside the appliance, except for those allowed by the manufacturer of this refrigeration appliance.



WARNING! Do not use mechanical devices or other means to accelerate the defrosting process, other than those recommended by the manufacturer.



WARNING! To avoid any hazard resulting from poor stability of the appliance, make sure it is installed as instructed.

Danger of frostbite

Never put frozen food in your mouth and avoid touching frozen food as this may cause frostnip or frostbite.

Safety of children and vulnerable persons

The appliance is not intended for use by persons (including children) with reduced physical, sensory or mental capabilities, or lack of experience and knowledge, unless they have been given supervision or instruction concerning use of the appliance by a person responsible for their safety.

Children should be supervised to ensure that they do not play with the appliance.

Cleaning and user maintenance shall not be made by children without supervision.

Remove the packaging intended to protect the appliance or particular parts during transport and keep it outside the reach of children.

It presents danger of injury or suffocation.

When removing a used appliance, disconnect the power cord, remove the door, and leave the shelves in the appliance. This will prevent children from locking themselves in the appliance.

For European markets only

This appliance can be used by children aged from 8 years and above and persons with reduced physical, sensory or mental capabilities or lack of experience and knowledge if they have been given supervision or instruction concerning use of the appliance in a safe way and understand the hazards involved.

Children shall not play with the appliance.

Cleaning and user maintenance shall not be made by children without supervision.

Children aged from 3 to 8 years are allowed to load and unload refrigerating appliances.

Warning regarding the refrigerant

The appliance contains a small amount of an environmentally friendly yet flammable gas R600a. Make sure that no parts of the cooling system are damaged. A gas leak is not hazardous to the environment, but it could cause eye injury or fire.

In case of a gas leak, ventilate the room thoroughly, disconnect the appliance from the power mains, and call a service technician.

IMPORTANT INFORMATION ON THE USE OF APPLIANCE

WARNING! This appliance is intended to be used in household and similar applications such as

- staff kitchen areas in shops, offices and other working environments;
- farm houses and by clients in hotels, motels and other residential type environments;
- bed and breakfast type environments;
- catering and similar non-retail applications.

 WARNING! Keep ventilation openings, in the appliance enclosure or in the built-in structure, clear of obstruction.

The appliance may not be used outdoors and it may not be exposed to rain.

Do not store explosive substances such as aerosol cans with a flammable propellant in this appliance.

If the appliance will be out of use for an extended period of time, switch it off using the relevant button, and unplug it from the power mains. Empty the appliance, defrost it, clean it, and leave the door ajar.

In the event of a defect or power cut, do not open the freezer compartment unless the appliance has been out of operation for more than the hours indicated on the appliance's type plate (temperature rise time). After this time, you must either use the frozen food or make sure that it is properly cooled (for example, by transferring it to another appliance).

Technical information on the appliance

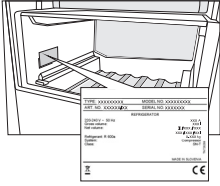

Rating plate can be found in the appliance interior (see figure). It indicates data on voltage, gross and net volume, type and amount of refrigerant, and information on the climate classes.



ENVIRONMENT PROTECTION

Packaging is made of environmentally friendly materials that can be recycled, disposed of, or destroyed without any hazard to the environment.



Removing an obsolete appliance

To protect the environment, take the obsolete appliance to an authorized home appliance collection centre.

Before doing so, do the following:

- disconnect the appliance from the power mains;
- do not allow children to play with the appliance.



WARNING! Do not damage the refrigerant circuit. This will also prevent pollution.



The symbol on the product or its packaging indicates that the product should not be treated as normal household waste. The product should be taken to an authorized collection centre for waste electric and electronic equipment processing. Correct disposal of the product will help prevent any negative effects on the environment and health of people which could occur in case of incorrect product removal. For detailed information on removal and processing of the product, please contact the relevant municipal body in charge of waste management, your waste disposal service, or the store where you bought the product.



ADVICE FOR SAVING ENERGY WITH REFRIGERATION APPLIANCES

- Install the appliance as specified in the instruction manual.
- Do not open the door more often than necessary.
- Occasionally make sure air circulation underneath the appliance is unobstructed.
- If the gasket is damaged or does not provide a perfect seal for any reason, have it replaced as soon as possible.
- Store the food in tightly sealed containers or appropriate packaging.
- Before placing the food in the refrigerator, allow it to cool down to room temperature.
- Defrost frozen food in the refrigerator compartment.
- To make use of the entire freezer compartment interior volume, remove some of the drawers as described in the instruction manual.
- Defrost your conventional freezer when an approximately 3-5 millimetre layer of frost or ice has built up on the refrigerated surfaces.
- Make sure the layout of shelves in the compartment is uniform and that the food is placed so that the air can freely circulate in the appliance interior (observe the recommended placement of food as described in the instructions).
- The lower the temperature is set the higher the energy consumption will be.

INSTALLATION AND CONNECTION

SELECTING THE ROOM

- Install the appliance in a dry and well ventilated room. The appliance will operate correctly if the environment temperature is in the interval specified in the table. The appliance class is indicated on the rating plate / label with the basic information on the appliance.

Class	Temperature	Relative Humidity
SN (subnormal)	from +10 °C to +32 °C	≤75%
N (normal)	from +16 °C to +32 °C	
ST (subtropical)	from +16 °C to +38 °C	
T (tropical)	from +16 °C to +43 °C	

-  • Do not place an appliance in a room where temperature can drop to below 5 °C as this may cause abnormal appliance operation or failure!

- After the installation, the appliance mains plug should be accessible!

Note: Place the appliance in a sufficiently large room. There should be at least 1 m³ of space per 8 grams of refrigerant. Amount of refrigerant is indicated on the rating plate in the appliance interior.

- At the base of the kitchen unit intended for building in the integrated appliance, there should be at least 200 cm² free space, for adequate air circulation.

On the upper part of the appliance the air is coming out, so try not to cover the opening for the outflow air. Ignoring this caution may result in damage to the appliance.

Warning: when installing built-in appliances into a cupboard or cabinet in a side-by-side layout, the dew prevention installation kit should also be purchased and installed. **For safety reasons, dew prevention kit may only be installed by an authorized service technician!**

CONNECTING THE APPLIANCE

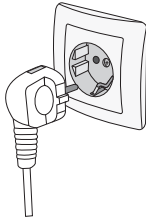

- Connect the appliance to the power mains using the power cord. The wall outlet should be fitted with a ground contact (safety socket). Nominal voltage and frequency are indicated on the rating plate/label with basic information on the appliance.
- The appliance must be connected to the power mains and grounded in compliance with the effective standards and regulations. The appliance will withstand short-term deviations from the nominal voltage, but not more than +/- 6%.

CHANGING THE DOOR OPENING DIRECTION AND INTEGRATING THE APPLIANCE INTO A CABINET

The process of changing the appliance door opening and integrating the appliance into a cabinet is described on the separate installation instructions supplied in the bag with the instruction manual.

APPLIANCE DESCRIPTION

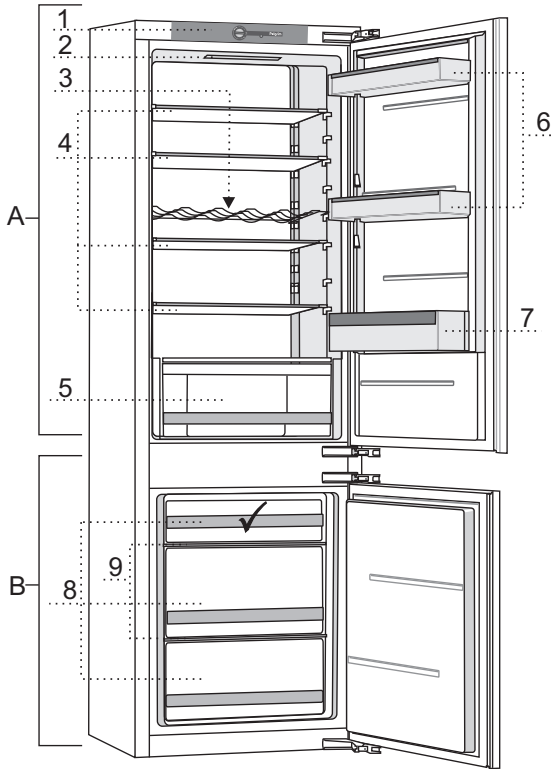

A Refrigerator

- 1 Control unit
- 2 LED lighting
- 3 Bottle rack
- 4 Glass shelves
- 5 Fruit and vegetable drawer with humidity control
- 6 Door balconies
- 7 Bottle balcony

B Freezer

- 8 Freezer drawers
- 9 Glass shelves

✓ Best location for freezing fresh food.

OPERATING THE APPLIANCE

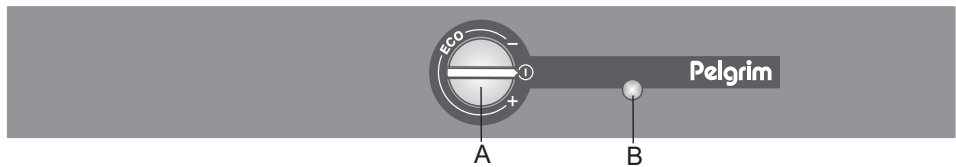

A Temperature setting and on/off knob

Use the dial to switch the appliance on or off, set the temperature, and control the ECO function.

B Lighting on/off key

Lighting will switch on automatically when you open the refrigerator compartment door, and it will switch off when you close it.

SWITCHING THE APPLIANCE ON/OFF

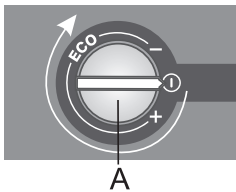

Switching on: Rotate the **A** dial clockwise.

Switching off: Rotate the **A** dial in the counter-clockwise direction until the arrow is aligned with the symbol **1** (Warning: appliance will remain powered, i.e. there will still be electric current in the appliance.)

ADJUSTING THE TEMPERATURE IN THE APPLIANCE

- i** • After the appliance is switched on, it may take several hours for the set temperature to be reached. Do not place any food into the refrigerator before the temperature drops to the selected setting.



A

- To set the desired temperature, rotate the **A** dial in clockwise direction.
- Recommended setting of the **A** dial is on the **ECO** position (see figure).
- A change in the ambient temperature will affect the temperature in the appliance. Adjust the setting with the **A** dial accordingly. Positions towards the - mean **a lower temperature in the appliance** (cooler). Settings towards the + mean **a higher temperature** (warmer).



A

If the ambient temperature in the room where the appliance is installed is below 16 °C, we recommend the coldest setting.

APPLIANCE INTERIOR EQUIPMENT

GLASS SHELVES

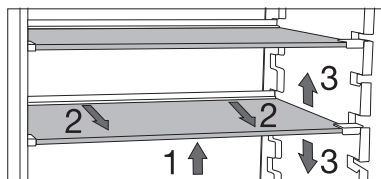

The shelves are made from safety glass. To change the height of a shelf, lift the front of the shelf (1). Take hold of the back and pull the shelf slightly forwards (2). Move the shelf to a higher or lower position (3).

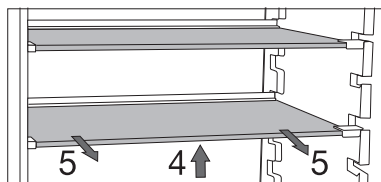

To remove a shelf from the refrigerator, lift the front of the shelf (4). Take hold of the back and pull the shelf out of the appliance (5).

BOTTLE RACK

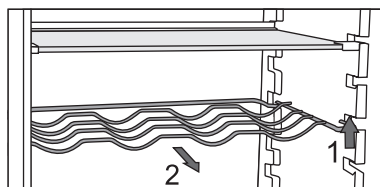

The bottle rack can contain a maximum load of nine 0.75-litre bottles or 13 kilograms of total weight. Also cans can be put on the bottle rack (lengthwise or crosswise). Make sure that the door can close correctly if you have put bottles or cans on the rack. The bottle rack cannot accidentally be pulled out. It can only be pulled out when it is empty. To pull it out, lift it slightly at the front (1) and pull it towards you (2).

VEGETABLES DRAWER WITH MANUAL HUMIDITY CONTROL



The drawer at the bottom of the refrigerator is intended for storing fruit and vegetables. It provides humidity and prevents the food from drying out. The drawer has a humidity regulator which allows setting the humidity level.

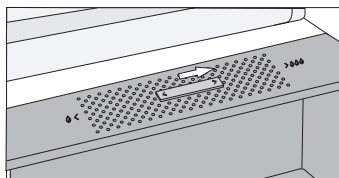

Slider position to the right: closed vents, higher humidity in the drawer

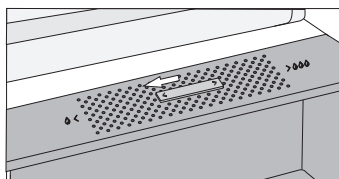

Slider position to the left: open vents, lower humidity in the drawer

i If you observe droplets accumulating below the glass shelf, open the vents and wipe the shelf.

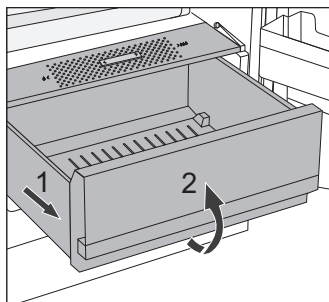

To remove a drawer, pull out the drawer as far as it will go (1). Then, lift the front part (2) and pull it out completely.

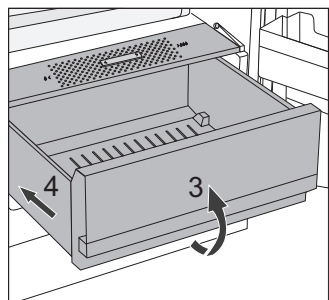

To insert a drawer, follow the reverse order (3 and 4).

HiddenSpace

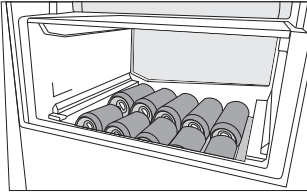

Extra storage out of sight.

The HiddenSpace compartment provides extra hidden storage for cans or similar items underneath the fruit and vegetable drawer.

DOOR COMPARTMENTS

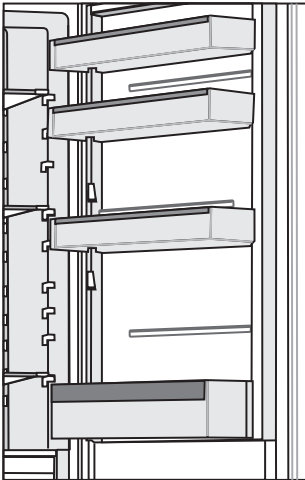

The height of the door compartments is adjustable. Lift the compartment out of the groove and fit it in the required position. Each compartment can carry a maximum weight of 5 kg. The bottom door compartment is suitable for bottles.



MultiBox

The MultiBox offers a handy option for storing foods with a strong odour, such as ripe or blue cheese, smoked sausages and onions. The lid can also be used as egg tray.

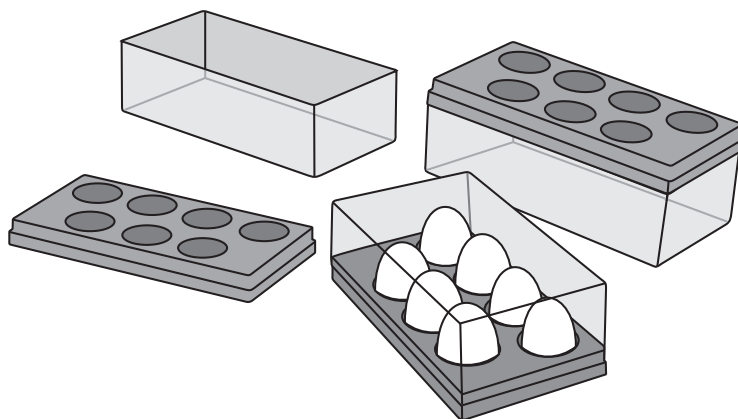

STORING AND FREEZING FOOD

RECOMMENDED DISTRIBUTION

Sections of the refrigeration compartment

- **Upper section:** canned food, bread, wine and pastas, etc.
- **Middle section:** dairy products, ready-to-cook meals, desserts, soft drinks, beer and cooked food, etc.
- **Lower section:** meat, meat produce, delicatessen.
- **Vegetable drawer:** vegetables and fresh fruit.

i Store food that spoils rapidly at the back of a shelf or at the back of the drawer at the lowest temperature.

i Do not store fruit (bananas, pineapples, papaya, citrus fruits) and vegetables (courgettes, tomatoes, aubergines, cucumber, sweet peppers and potatoes) that are sensitive to low temperatures in the refrigerator.

Sections of the door

- **Top/middle door** compartment: eggs, butter, cheese and sauces, etc.
- **Bottom door compartment:** drinks, cans and bottles, etc.

Sections of the freezer compartment

- **Top section:** leftovers, ice, pizza.
- **Middle section:** meat, fish, bread.
- **Bottom section:** standard freezer, vegetables and fruit.

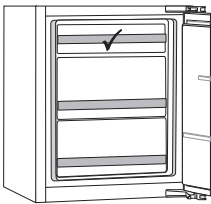

The best location for freezing fresh food is marked with a ✓.

i Do not store lettuce, eggs, apples, pears, grapes, peaches, yoghurt, buttermilk, sour cream or mayonnaise in the freezer.

AVOID CONTAMINATION OF FOOD

To avoid contamination of food, please respect the following instructions:

- Opening the door for long periods can cause a significant increase of the temperature in the compartments of the appliance.
- Regularly clean surfaces that can come in contact with food and accessible drainage systems.
- Store raw meat and fish in suitable containers in the refrigerator, so that it is not in contact with or drip onto other food.
- If the refrigerating appliance is left empty for long periods, switch off, defrost, clean, dry, and leave the door open to prevent mould developing within the appliance.

STORING FRESH FOOD IN THE REFRIGERATOR

Important recommendations for storing fresh food

- To ensure the quality of fresh food, it is important that:
 - the food is well-packaged;
 - the appliance is at the correct temperature;
 - the appliance is clean.
- Take good note of the use-by date stated on the food packaging.
- Put food in the refrigerator in sealed containers or in suitable packaging. This will prevent the food from picking up or spreading odours and will keep it dry.
- Do not store flammable, unstable or explosive materials in the refrigerator.
- Store bottles that have been opened upright and close them tightly.
- Some organic solutions, such as essential oils, in the skin of lemons and oranges, and butyric acid, that come into long-term contact with plastics can eat into the material and cause premature ageing.
- A disagreeable odour is an indication that the appliance is not clean or that it contains food that has spoiled (see the chapter 'Maintenance').
- Take perishable foods out of the refrigerator when you will be away from home for a longer time.

FREEZING AND STORING FOODS IN THE FREEZER

Important recommendations for freezing fresh food

- The maximum quantity of food that you can put in the freezer in one go is stated on the type plate. Putting more than this maximum quantity of food into the freezer will slow the freezing process and reduce the quality. Moreover, this will also harm the quality of frozen food already stored in the freezer.
- Use only good-quality fresh food that is suitable for freezing.
- Allow hot food to cool to room temperature.
- Food needs to be frozen quickly. It is recommended that you use small packs.
- Use air and watertight packaging to prevent the food from drying out and lose its vitamins.
- Note the type and quantity of the food on the packaging, together with the date on which it was frozen.
- Do not allow fresh food to come into contact with frozen food.
- You can remove all the drawers to make use of the total volume of the freezer compartment.
- Put the food directly on a shelf and on the base of the freezer.

Freezing small quantities of fresh food/making ice cubes

See the chapter 'Recommended distribution' for the best location for freezing fresh food (1 to 2 kilograms) and making ice cubes.

Freezing large quantities of fresh food

- The day before you want to freeze large amounts of fresh food at the same time, you can set the thermostat knob to the lowest temperature setting. Set the thermostat knob to the normal position when the food is frozen.
- Distribute the fresh food equally between all the drawers in the freezer compartment.
- After 24 hours, you can transfer the food to another compartment in the freezer and then freeze a new batch of food.

Important recommendations for storing frozen food

- Follow the manufacturer's instructions for the storage and use of frozen food. Take note of the recommended storage temperature and use-by date stated on the packaging.
- Use only food in undamaged packaging that has been stored at a temperature of -18 °C or lower.
- Do not buy food covered in frost. This indicates that the food has thawed or partially thawed several times and, as a result, is of inferior quality.
- Make sure that the food does not thaw during transport. An increase in its temperature will shorten the storage life and harm the quality of the food.

Recommended storage times of frozen food in the freezer ✖***

Type of food	Storage life
Fruit, beef	10 to 12 months
Vegetables, veal, poultry	8 to 10 months
Venison	6 to 8 months
Pork	4 to 6 months
Finely chopped or minced meat	4 months
Bread, pastas, cooked dishes, whitefish	3 months
Offal	2 months
Smoked sausage, bluefish	1 month

THAWING FROZEN FOOD

- Thawing is an important step in storing food preserved by freezing. Food must be thawed in the correct way.
- Suitable methods of thawing food are:
 - in the refrigerator;
 - in cold water;
 - in a microwave or conventional oven with a suitable thaw program.
- Some frozen products can be prepared without needing to thaw them first. The manufacturer will state this on the packaging.
- The food needs to be packed in small portions. In this way the food thaws faster.
- Use partially or completely thawed food as quickly as possible. The bacteria in thawed food are reactivated and the food will spoil rapidly. This applies in particular to fruit, vegetables and ready-made food.
- Do not refreeze partially or completely thawed food.

DEFROSTING THE APPLIANCE

AUTOMATIC REFRIGERATOR DEFROSTING

This refrigerator does not need defrosting because the ice on the back interior wall is thawed automatically.

Any accumulated ice will melt when the compressor unit is inactive. Drops will flow through an opening in the refrigerator rear wall into a tray fitted above the compressor, from where they will evaporate.

Make sure the opening in the back wall in the refrigerator interior is never blocked by food or any other object.

If an excessive layer of ice is formed on the rear wall of refrigerator interior (3-5 mm), switch off the appliance and defrost the appliance manually.

DEFROSTING A CONVENTIONAL FREEZER

- Defrost the freezer when an approximately 3-5 millimetre layer of frost or ice has built up.
- 24 hours before defrosting, set the appliance to the coldest setting.

After this period, remove the food from the freezer and protect it from defrosting.

- Switch off the appliance (see chapter Operating the Appliance) and unplug the power cord.
- Do not use any defrosting sprays as they may melt the plastic parts or harm your health.
- Do not use a knife or any other sharp object to remove the frost, because you may damage a pipe of the cooling system.
- Clean and dry the appliance interior (see chapter Cleaning the Appliance).

CLEANING THE APPLIANCE



Before cleaning, unplug the appliance from the power mains – switch off the appliance (see chapter Operating the Appliance) and unplug the power cord from the wall outlet.



Cleaners that contain abrasive substances, acids, or solvents are not suitable for cleaning as they may damage the surface.

Regularly clean the interior of the appliance with lukewarm water. If so required, add a neutral cleaning agent or special refrigerator cleaner to the water. Clean all surfaces with a soft cloth. Wipe the cleaned parts with a cloth with clean water and then dry them thoroughly.



• Do not wash the parts of appliance interior equipment in a dishwasher as they may be damaged.

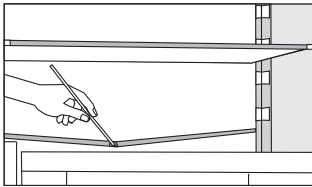

- A gutter and an opening for discharging the water from thawed frost deposits are located underneath the cooling panel that cools the refrigerator interior. The gutter and the opening may not be clogged. Inspect them often and clean if necessary (e.g. with a plastic straw).
- After cleaning, switch the appliance back on and insert the food.

TROUBLESHOOTING

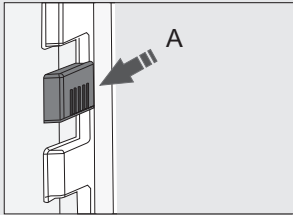
Problem:	Cause or remedy
Appliance is connected to the power mains but it does not work.	<ul style="list-style-type: none"> • Make sure there is voltage in the power outlet and that the appliance is switched on.
Cooling system operates continuously for a long period of time: 	<ul style="list-style-type: none"> • Too high ambient temperature. • Door opened too frequently or too long. • Door not closed correctly (possible impurities on the seal, misaligned door, damaged seal etc.). • Too much fresh food inserted at once. • Sensor in the refrigerator (A) blocked by fresh food. Make sure the air can circulate around the sensor (only with some models). • Insufficient compressor and condenser unit cooling. Check for sufficient air circulation behind the appliance and clean the condenser unit.
Excessive build-up of ice on the back wall of refrigerator interior can be a result of the following:	<ul style="list-style-type: none"> • The door is not closed properly. • Warm food placed in the refrigerator. • Food or containers in contact with the back interior wall of the refrigerator. • The door does not seal properly (the seal is dirty, the door is misaligned or the seal is damaged, etc.).
Build-up of ice or frost in the freezer interior may be a result of the following:	<ul style="list-style-type: none"> • The freezer compartment has not been defrosted periodically. Defrost the freezer compartment to remove the ice. • The door is not closed properly. • The door does not seal properly (the seal is dirty, the door is misaligned or the seal is damaged, etc.).
Condensate (dew) on the shelf above the drawers:	<ul style="list-style-type: none"> • This is transient phenomenon which cannot be entirely avoided in periods of high environment temperature and humidity. It subsides when temperature and humidity are normalized. We recommend cleaning the drawers more frequently and wiping the droplets occasionally. • Open the humidity control slider. • Put food in to bags or other airtight packaging.

Problem:	Cause or remedy
Water is dripping/leaking from the refrigerator:	<ul style="list-style-type: none"> • Clogged water discharge opening or water dripping past the water gutter. • Clean the blocked opening, e.g. using a plastic straw. • If a thick layer of ice builds up, defrost the appliance manually (see Defrosting the Appliance).
Door is difficult to open:	<ul style="list-style-type: none"> • If you are trying to open the freezer door after just having closed it, this could be difficult to do. As you open the door, some cool air escapes from the appliance and it is replaced by warm air from the environment. When this air is cooled, negative pressure is generated which results in problems as you try to open the door. After a few minutes, the condition is normalized and the door can be easily opened again.
LED lighting does not work:	<ul style="list-style-type: none"> • If LED lighting does not work, call a service technician. • Do not attempt a repair of the LED lighting yourself, as there is danger of contact with high voltage!
Appliance makes a noise.	<ul style="list-style-type: none"> • The appliance is cooled by a refrigeration system with a compressor (and with some models, also a fan) that makes a noise. The noise level depends on the installation of the appliance, its correct use and its age. • When you connect the appliance to the power supply the noise made by the compressor or flowing refrigerant may be slightly louder. This is not indicative of a defect, and has no effect on the service life of the appliance. The appliance will make less noise after a while. • The appliance may be temporarily noisier after the door has been opened for too long or too frequently, or a large quantity of fresh food has been put in the appliance.

If the above tips do not resolve your problem, call the nearest authorized service centre and state the type, model, and serial number indicated on the appliance rating plate or label located in the appliance interior.

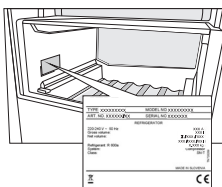

Rating plate can be found in the appliance interior (see figure).

Pelgrim

COMBI BI540 ESS PEL



594964

en (07-19)