

134

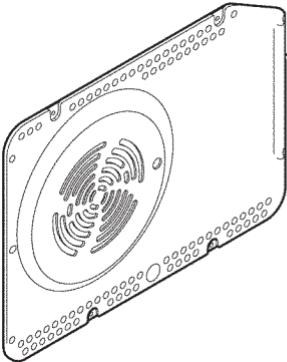

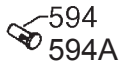

9493047427

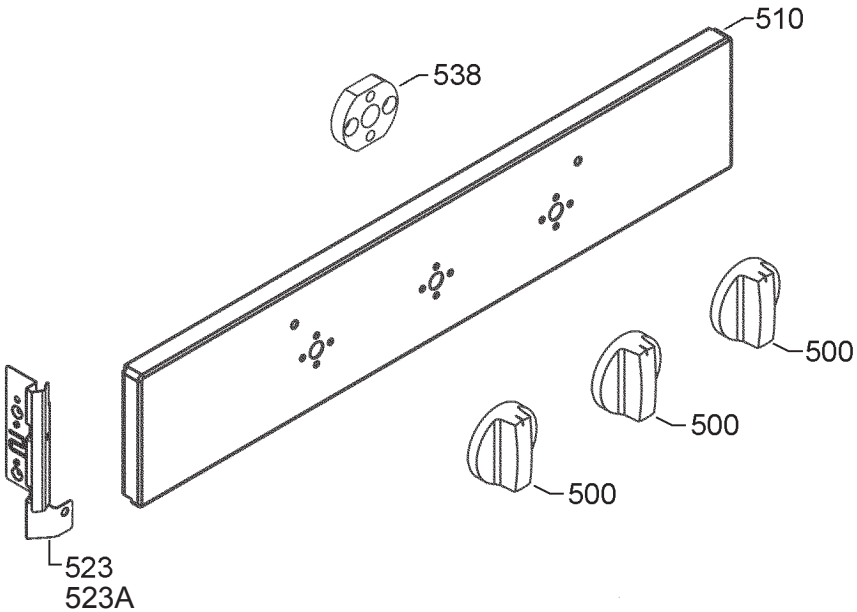