

Thank you for your trust and for buying this appliance. We hope it will successfully serve the purpose for many years.

Refrigerator is for domestic use only and is intended for storing fresh foods at the temperature higher than 0°C.

Before Putting Into Use	40-41
Placing and Installation	42
Description of the Appliance	43
Operation Control	44
Use	45-46
Maintenance and Cleaning	47-48
Trouble-Shooting Guide	49-50

- Before connecting the appliance to the mains supply, leave it stand for about 2 hours, which will reduce a possibility of malfunctions in the cooling system due to transport handling.
- Clean the appliance, and be thorough, especially in the interior (See Cleaning and Maintenance).
- In case the interior accessories are not correctly placed, rearrange them as described in chapter "Description of the Appliance".

Instructions for use

- These instructions for use are intended for the user. They describe the appliance and its correct and safe use. They were prepared for various types/models of refrigerators therefore you might find in it description of some functions and accessories that your appliance does not have.

Mounting instructions

Integrated appliances are equipped with instructions for mounting the appliance into the kitchen unit. The appliance should be professionally mounted by qualified technician and instructions are for his use only.

We care for the environment

- Our appliances are distributed in packaging made of environmental friendly material which could safely be recycled, disposed off or destroyed, with no effects on the nature whatsoever.
- These instructions are printed either on recycled paper or chlorine free bleached paper.
- When your appliance finally wears out, please try not to burden the environment with it; call your nearest authorised service agent. (See Disposing of the Worn Out Appliance)

Tips for energy savings

- Try not to open the door too often, especially when the weather is wet and hot. Once you open the door, mind to close it as soon as possible. This is especially important if you have an upright model.
- Check periodically if the appliance is provided with sufficient cooling (undisturbed circulation of air through the bottom rail openings).

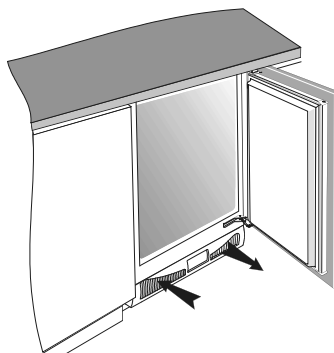

- Turn the thermostat knob from higher to lower setting as soon as possible (depends on how loaded the appliance is, ambient temperature...).
- Before loading the appliance with fresh food, make sure it was cooled to ambient temperature.
- Ice and frost layer increase energy consumption, so do clean the appliance as soon as the layer is 3-5 mm thick.
- If the gasket is damaged or if it turns out that the sealing is poor, the energy consumption is substantially higher. To restore efficiency, replace the gasket.
- Condenser at the bottom of the appliance must always be clean and dust free (see Section Cleaning of the Appliance).

- Always consider instructions stated in sections Positioning and Energy Saving Tips, otherwise the energy consumption is substantially higher.

Important

- If you have bought this appliance to replace an old one equipped with a lock that cannot be opened from inside (lock, bolt), make sure that the lock is broken. This will make it impossible for children to lock themselves inside the appliance and suffocate.
- The appliance must be correctly connected to the mains supply. (see: Connecting to the Mains Supply).
- If the food has strange smell or color, throw it away, because it is very likely that it is spoiled and therefore dangerous to eat.
- Disconnect the appliance from the power supply before repairing it (only a qualified technician should repair it), before cleaning and before replacing the light bulb.
- Do not defrost the appliance with other electric appliances (as for example with hair dryer) and never scrape the frost layer with sharp objects. Use only enclosed tools or tools recommended by the manufacturer.
- For the sake of environment protection - be careful not to damage the rear wall of the appliance (the condenser unit or the tubes - for example when moving the appliance) or any part of the refrigerating system inside the appliance. Do not use sharp object for defrosting the appliance. Use only enclosed tools or tools recommended by the manufacturer.

- The refrigerating system of the appliance is filled with refrigerant and oil, so when the appliance is damaged, handle it with care and dispose it of in compliance with environmental protecting precautions. (See We Care for the Environment).

- If the supply cord is damaged, it must be replaced by the manufacturer or his service agent or a qualified person in order to avoid hazard.
- The rating plate is inside the appliance or outside on the rear wall.



The symbol on the product or on its packaging indicates that this product may not be treated as household waste.

Instead it shall be handed over to the applicable collection point for the recycling of electrical and electronic equipment. By ensuring this product is disposed of correctly, you will help prevent potential negative consequences for the environment and human health, which could otherwise be caused by inappropriate waste handling of this product. For more detailed information about recycling of this product, please contact your local city office, your household waste disposal service or the shop where you purchased the product.

Disposing of the worn out appliance

- When your appliance finally wears out, dispose it of. If the appliance has a lock, break it, in order to prevent eventual accidents (danger of children get locked inside the appliance).
- The refrigerating system of the appliance is filled with refrigerant and insulating substances which should be separately treated and processed. Call your nearest authorised service agent or specialised servicing centre. If you don't find one, contact your local authorities or your distributor. Be careful not to damage the tubes on the rear wall of the appliance (danger of pollution).
- To avoid pollution of the environment make sure not to damage the hose at the bottom of the appliance.

Choosing the right place

Place the appliance in a dry and regularly ventilated room. Allowed ambient temperature depends on the model (class) of the appliance and is stated on the rating plate of the appliance.

Never place the appliance near heat emitting devices (e.g. cooker, radiator, water heater or similar devices) and do not expose it to direct sunlight.

The appliance should be positioned at least 3 cm away from the electric or gas cooker and at least 30 cm away from the oil or coal stove. If this is not possible, use an appropriate insulation.

Class	Ambient temperature
SN (subnormal)	from +10°C to +32°C
N (normal)	from +16°C to +32°C

Connection to power supply

Connect the appliance with the cable and plug to the power supply socket outlet with a ground terminal (safety socket).

Required nominal voltage and frequency are indicated on the rating plate.

The connection to the mains supply and earthing have to be made according to current standards and regulations. The appliance resists temporary voltage tolerance up to -6 to +6 %.

Adjusting the height of the appliance

The appliance is equipped with four adjustable legs, so that the height may be adjusted from 82 to 90 cm. The height must be adjusted prior building the appliance into the opening slot, and it should be set at such height that the top panel of the appliance fits exactly below the kitchen worktop (see Mounting Instructions).

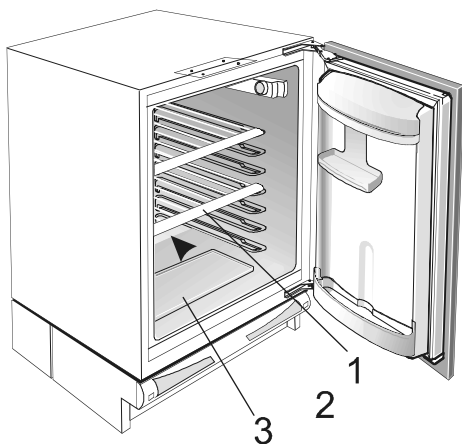

Shelf (1)

The shelf may be placed randomly upon any of the guide slots within the interior of the appliance. It is protected against sliding out.

The shelf is placed upon the top four guides by lowering the front section of the shelf downwards, the rear of the shelf is placed upon the guide slot and the shelf is inserted in the guide in the inclined position.

The shelf is placed upon the top four guides by lifting the front section of the shelf upwards, the rear of the shelf is placed upon the guide slot and the shelf is inserted in the guide in the inclined position.

In case you wish to remove the shelf from the appliance lift the shelf by hand at the rear and pull it out in the opposite procedure.

Glass shelves are protected with plastic edge frames.

Quickly perishable food should be stored on the back i.e. the coldest part of the shelves.

Defrost Water Outlet (2)

The interior of the refrigerator is cooled with cooling plate incorporated in the rear wall. Under the plate there is a channel and an outlet for defrost water.

Regularly check the defrost water outlet and the channel, because they should never be clogged (as for example with food rests). If clogged, use a plastic straw and clean it.

Crisp tray and serving tray (3)

The tray at the bottom of the refrigerator is covered with the serving tray. This cover protects the stored fruit and vegetables from excessive drying.

Door Liner

The door liner consists of various shelves or holders used for storing eggs, cheese, butter and yogurt as well as other smaller packages, tubes, cans etc. The lower shelf is used for storing bottles.

Illumination in the Interior of the Refrigerator

The light for illuminating the interior of the appliance is on, when the door is opened. The operation of the light does not depend on the position of the thermostat knob.

The appliance is controlled with thermostat knob, situated in the right upper part inside the appliance. Turn the knob from STOP (0) position towards 7 and backwards.

Temperature selection

- Higher settings on the knob (towards 7) mean lower temperatures (colder) in all three compartments of the appliance. Temperature in the interior of the appliance may even drop below 0°C. Higher settings should be used only in case higher temperature is recommended or required. When the ambient temperature is normal, we recommend medium setting.
- Changes of the ambient temperature affect temperature in the interior of the appliance (choose correct setting of the thermostat knob).
- In STOP (0) position the appliance does not operate (the cooling system is switched off), yet power supply is not interrupted (the light is on, when you open the refrigerator door).
- Temperature in the refrigerator also depends on how often the door is opened.

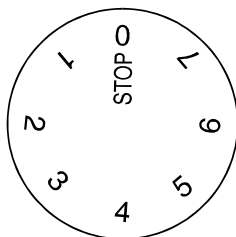

Storing fresh foods

Proper use of the appliance, adequately packed food, correct temperature and taking into account hygienic precautions will substantially influence the quality of the food stored.

- Foods to be stored in the refrigerator should be properly packed as to prevent mixing various moisture degrees and odors (in polyethylene bags or sheet, aluminium foil, wax paper, or stored in covered containers or bottles).
- Before storing food in the refrigerator, remove the excessive packaging (like yoghurt in multi-package).
- Pack systematically and make sure that foodstuffs do not touch each other (various odours may mix). Assure adequate air circulation around packages.
- Never store inflammable, volatile or explosive substances.
- Beverages with high alcohol percentage should be stored in tightly sealed bottles in vertical position.
- Food should not touch the rear wall of the refrigerator!
- Foods should be cooled down before storing.
- Crispy and delicate foods should be stored in the coldest parts of the refrigerator.
- Try not to open the door too often.
- Set the thermostat to the setting where lowest temperatures are reached. Set the thermostat gradually as to avoid freezing of the foods. Use a thermometer and measure the temperature in the individual compartments. Place the thermostat in a glass vessel filled with water. Temperature readings are most reliable few hour after steady state is reached.
- Some organic solutions like volatile oils in lemon or orange peel, acid in butter etc. could cause damage and when in contact with plastic surfaces or gaskets for longer period of time they can even cause accelerated ageing of the plastic material.
- Unpleasant odor inside the refrigerator is a sign that something is wrong with foods or that your refrigerator needs cleaning. Unpleasant odor can be eliminated or reduced by washing the interior of the refrigerator with a mild solution of water and vinegar. We also recommend using activated carbon filters to clean the air or to neutralize odors.
- If you plan a longer journey, make sure to remove quickly perishable articles of food out of the appliance before you leave.

Fresh Food Storage Time in the Refrigerator

Article of food	Storage time (days)													
	1	2	3	4	5	6	7	8	9	10	11	12	13	14
Butter	+	+	+	+	+	+	+	=	=	=	=	=		
Eggs	+	+	+	+	+	+	+	+	+	+	=	=	=	=
Meat: fresh uncut chopped smoked	+	+	=											
	+	=												
	+	+	+	+	+	+	+	+	+	+	=	=	=	=
Fish	+	=												
Marinade	+	+	+	+	+	+	+	+	+	+	=	=	=	=
Root	+	+	+	+	+	+	+	+	=	=	=	=	=	=
Cheese	+	+	+	+	=	=	=	=	=	=	=	=	=	=
Sweets	+	+	=	=	=	=								
Fruit	+	+	=	=	=	=	=	=	=	=				
Prepared dishes	+	+	=	=										

Legend: + recommended storage time

= possible storage time

Automatic defrosting of the refrigerator

The refrigerator requires no defrosting, since the ice at the rear wall melts automatically. Ice, formed at the rear end during the operation of the compressor, melts when the compressor is off, and water drops slide downwards through the hole in the rear wall of the condenser collecting receptacle, placed at the bottom of the appliance.

Cleaning the appliance

Disconnect the power supply before cleaning the appliance.

Do not use coarse or aggressive cleaning agents as you can damage the surface. Be careful to remove any cleanser agent remaining after cleaning.

- Clean the exterior with water and detergent.
- Remove the detachable accessories in the interior of the appliance and clean it with water and liquid detergent. Plastic parts cannot be washed in washing machine.
- Wash the interior of the appliance with lukewarm water, in which you added one or two spoonfuls of vinegar.
- The air openings in the bottom rail should be cleaned or vacuumed periodically.

Cleaning of the condenser

Dust from the condenser should be vacuumed in the following manner:

- push the finger through the opening in the bottom rail and release the fastener;
- pull the rail towards you and remove it;
- remove the bottom board of the kitchen cabinet
- pull the condenser dish out;
- use the vacuum cleaner to clean the dust from the condenser;
- replace the condenser dish and the bottom rail in the opposite order.

After cleaning, connect the appliance to power supply and reload it.

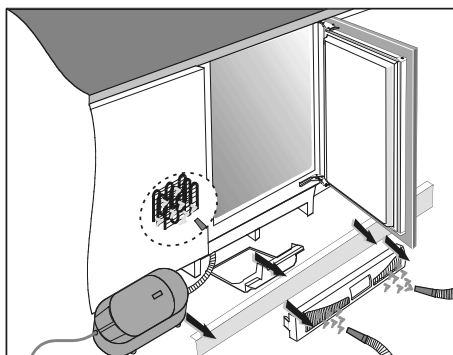

Periodical cleaning of the condenser

In order to optimize the operation of the appliance and save energy, it is recommended to clean periodically the dust from the condenser at the back of the appliance.

Disconnect the appliance from the mains prior the commencement of cleaning!

- Empty the contents of the appliance.
- Remove the supporting panel from the bottom of the kitchen cabinet.
- Remove the screws fixing the appliance to the kitchen worktop.
- Pull the appliance out and expose the condenser at the back of the appliance.
- Unscrew the screws from the condenser bonnet and remove the bonnet.
- Clean the dust and dirt from the condenser.
After cleaning return the appliance to its place, plug in the mains power cord and fill with food.

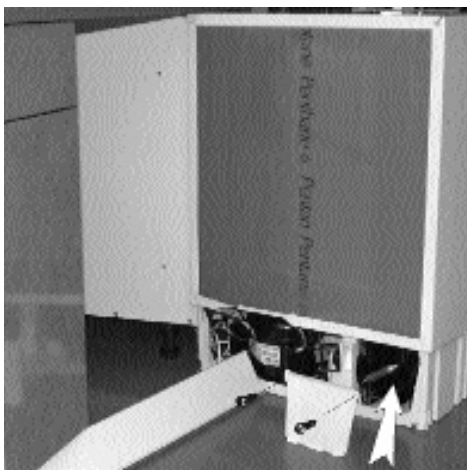

Switch off the appliance when not in use

If you do not intend to use the appliance for a longer period, set the thermostat knob to the STOP (0) position, disconnect the power supply, take out the foods and defrost and clean the appliance. Leave the door slightly open.

During the service, you can come across some troubles that in most cases result from improper handling of the appliance and can easily be eliminated.

The appliance fails to operate after connecting to the mains supply

- Check the supply in the outlet socket and make sure the appliance is switched on (thermostat knob in operating position).

Continuous operation of the cooling system

- The door was frequently opened or it was left open for too long.
- The door is not properly closed (the door may sag, the gasket may be polluted or damaged).
- Perhaps you have overloaded the appliance with fresh foods.
- Insufficient cooling of compressor and condenser.
- Check the air circulation through the bottom rail openings and if necessary clean or vacuum the dust from the condenser. See Section Cleaning and Maintenance.

Ice formation on the inner rear wall

Until the water is drained through the hole in the rear and into the receptacle at the bottom of the appliance, normal automatic defrosting of the appliance is guaranteed.

In case the ice formation on the inner back wall is increased (3-5 mm), ice should be manually defrosted. Set the thermostat knob to STOP (0) position and leave the door open. Never use electric devices for defrosting and do not scrape the ice or frost layer with sharp objects.

After completed defrosting, turn the knob to desired position and close the refrigerator door.

The cause of increased ice formation may be one of the following:

- the door does not seal well (clean the gasket if it is contaminated, or replace it if it is damaged);
- the door was frequently opened or it was left open for too long;
- the food stored in the refrigerator was warm;
- the food or dish is touching the inner back wall.

Sound alarm

The excessive dust upon the condenser is signaled by the sound alarm, heard at each opening of the appliance door until the default is removed. Check the air circulation through the bottom rail openings and if necessary clean or vacuum the dust from the condenser. See Section Cleaning and Maintenance.

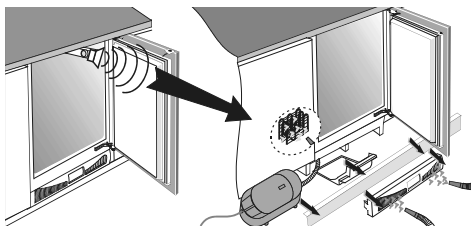

Water drains into the bottom compartment of the appliance

Water leaks from the refrigerator if the drain hole is clogged, or if the water drips past the collection gutter.

- Clean the clogged outlet, for example with a plastic straw.
- Manually defrost the increased ice layer. See "Ice Formation on the Inner Rear Wall".

Cooling in refrigerating-freezing appliances is enabled by the cooling system with compressor, which produces noise. How noisy the appliance is depends on where it is placed, how it is used and how old the appliance is.

- During the operation of the compressor the noise of liquid is heard and when the compressor is not operating, the refrigerant flow is heard. This is a normal condition and it has no influence whatsoever on the lifetime of the appliance.
- After starting the appliance, the operation of the compressor and the refrigerant flow may be louder, which does not mean that something is wrong with the appliance and it has no influence on the lifetime of the appliance. Gradually the noise is reduced.
- Sometimes unusual and stronger noise is heard, which is rather unusual for the appliance. This noise is often a consequence of inadequate placing.
- The appliance shall be placed and levelled firmly on solid base.
- It should not touch the wall or kitchen units standing next to it.
- Check the accessories in the interior of the appliance, they should be placed correctly in their positions; also check the bottles, tins and other vessels that might touch each other and rattle.

Bulb replacement

Before replacing the light bulb, disconnect the appliance from the power supply. Press the cover at the rear side (in the arrow 1 direction) and remove the plastic cover (in the arrow 2 direction). Replace the bulb with a new one (E14, max. 15 W). Don't forget: the old bulb does not belong to organic waste.

Light bulb is consuming good therefore our in-guarantee service does not relate to it.

Bulb lamps used in this appliance are special purpose lamps selected for household appliances use only. They are not suitable for household room illumination.

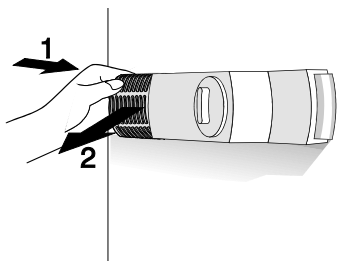

WE RESERVE THE RIGHT TO ALTER THE SPECIFICATIONS WITH NO INFLUENCE ON THE OPERATION OF THE APPLIANCE.