

freezer

Thank you for your trust and for buying this appliance. We hope it will successfully serve the purpose for many years.

The freezer for domestic use is intended for freezing fresh food and for long-term storing of frozen food (up to one year, depending on the kind of food).

Before putting into use	58-61
Placing and installation	62
Description of the appliance	63
Operation control	64-65
Use	66-68
Maintenance and cleaning	69-71
Trouble shooting guide	72-74

instructions for use

before putting into use



- Before connecting the appliance to the mains supply, leave it stand for about 2 hours which will reduce the possibility of malfunctions in the cooling system that might have occurred due to transport handling.
- Clean the appliance thoroughly, especially the interior (see Cleaning and Maintenance).

instructions for use

These instructions for use were prepared for the user. They describe the appliance and its correct and safe use. They were prepared for various types/models of appliances therefore you might find in it description of some functions and accesories that do not apply to your appliance.

mounting instructions

Integrated appliances are equipped with instructions for mounting the appliance into the kitchen unit. The appliance should be professionally mounted by qualified technician and instructions are for his use only.

we care for the environment

- Our products use environmentally friendly packaging, which can be either recycled or disposed of in an environmentally friendly manner. To this end, individual packaging materials are clearly marked.
- These instructions are printed either on recycled paper or chlorine free bleached paper.
- When your appliance finally wears out, please try not to burden the environment with it; call your nearest authorised service agent. (See Disposing of the Worn Out Appliance)

before putting into use

tips for energy savings

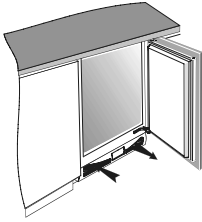

- This is especially important if you have an upright model.
- Check periodically if the appliance is provided with sufficient cooling (undisturbed circulation of air through the bottom rail openings).
- Turn the thermostat knob from higher to lower setting as soon as possible (depends on how loaded the appliance is, ambient temperature...)
- Never use continuous operation unless unnecessarily required; switch the operation mode selection switch to the setting for automatic operation as soon as possible.
- Before freezing packages of fresh foods, make sure they are cooled to ambient temperature. (except for the soup)
- Ice and frost layer increase energy consumption, so do clean the appliance as soon as the layer is 3-5 mm thick.
- If the gasket is damaged or if it turns out that the sealing is poor, the energy consumption is substantially higher. To restore efficiency, replace the gasket.
- Condenser at the bottom of the appliance must always be clean and dust free (see Section Cleaning of the Appliance).
- Always consider instructions stated in sections Positioning and Energy Saving Tips, otherwise the energy consumption is substantially higher.

important



- If you've bought this appliance to replace an old one equipped with a lock that cannot be opened from inside (lock, bolt), make sure that the lock is broken. This will make it impossible for the children to lock themselves in the appliance and suffocate.
- Mind to connect the appliance correctly to the mains supply (see Connection to the Mains Supply).
 - Do not touch the cooled surfaces while the appliance operates, especially not with wet hands, because the skin might stick to the cold surfaces.

instructions for use

before putting into use

- Do not freeze bottled drinks, especially not fizzy ones such as mineral water, sparkling wine, beer, cola etc., because liquid expands during freezing and the glass bottle is very likely to blow up.
- Never try to eat frozen food (bread, fruit, vegetables), because you may get frostbites.
- Carefully check the foods for color and smell and if you are in doubt about their quality, throw them away because they may be spoiled and therefore dangerous to eat.
- Disconnect the appliance from the mains before repairing (only a qualified technician should repair it) and before cleaning.
- Use only enclosed tools or tools recommended by the manufacturer.
- For the sake of environment protection - be careful not to damage the rear wall of the appliance (the condenser unit or the tubes - for example when moving the appliance) or any part of the refrigerating system inside the appliance. Do not use sharp object for defrosting the appliance. Use only enclosed tools or tools recommended by the manufacturer.
- The refrigerating system of the appliance is filled with refrigerant and oil, so when the appliance is damaged, handle it with care and dispose it of in compliance with environmental protecting precautions. (See We Care for the Environment).
- Heating element incorporated in the appliance, all around the rim, is controlled by the operation of the compressor and it prevents the door gasket to freeze on to the freezer housing.
- In the supply cord is damaged, it must be replaced by the manufacturer or his service agent or a qualified person in order to avoid hazard.
- The rating plate is in the interior or on the rear wall of the appliance.



The symbol on the product or on its packaging indicates that this product may not be treated as household waste. Instead it shall be handed over to the applicable collection point for the recycling of electrical and electronic equipment. By ensuring this product is disposed of correct-

before putting into use

ly, you will help prevent potential negative consequences for the environment and human health, which could otherwise be caused by inappropriate waste handling of this product. For more detailed information about recycling of this product, please contact your local city office, your household waste disposal service or the shop where you purchased the product.

Storing Time During Power Supply Interruption

Avoid opening the freezer in case of failure or power supply interruption! In case the interruption is extended over longer period of time (15 hours).

disposing of the worn out appliance

- When your appliance finally wears out, dispose it of. If the appliance has a lock, break it, in order to prevent eventual accidents (danger of children get locked inside the appliance).
- The refrigerating system of the appliance is filled with refrigerant and insulating substances which should be separately treated and processed. Call your nearest authorised service agent or specialised servicing centre. If you don't find one, contact your local authorities or your distributor. Be careful not to damage the tubes on the rear wall of the appliance (danger of pollution).
- To avoid pollution of the environment make sure not to damage the hose at the bottom of the appliance.

instructions for use

placing and installation

choosing the right place

Place the appliance in dry and well ventilated room. Allowed ambient temperature depends on the model (class) of the appliance and is stated on the rating plate of the appliance. Never place the appliance near heat emitting devices (e.g. cooker, radiator, water heater and similar devices) and do not expose it to direct sunlight.

The appliance should be positioned at least 3 cm away from the electric or gas cooker and at least 30 cm away from the oil or coal stove. If this is not possible, use an appropriate insulation.

Class	Ambient temperature
SN (sub-normal)	from + 10°C to + 32°C
N (normal)	from + 16°C to + 32°C

connection to power supply

Connect the appliance with the cable and plug to the power supply socket outlet with a ground terminal (safety socket).

Required nominal voltage and frequency are indicated on the rating plate.

The connection to the mains supply and earthing have to be made according to current standards and regulations. The appliance resists temporary voltage tolerance up to -6 to +6 %.

adjusting the height of the appliance

The appliance is equipped with four adjustable legs, so that the height may be adjusted from 82 to 90 cm. The height must be adjusted prior building the appliance into the opening slot, and it should be set at such height that the top panel of the appliance fits exactly below the kitchen worktop (see Mounting Instructions).

description of the appliance

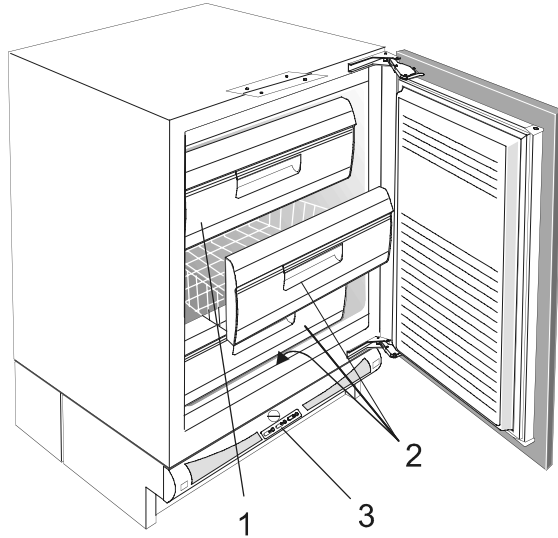

Freezing Compartment (1)
is used for freezing fresh foods.

Storing Basket (2)
is used for storing packages of frozen foods.

Control Panel (3)
See Operation Controls

instructions for use

operation control

The freezer is controlled with switches and thermostat button, incorporated in the bottom section of the appliance.

control panel

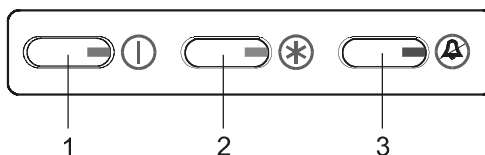

- 1 ON/OFF switch (green signal lamp)
- 2 Continued operation button (yellow signal lamp)
- 3 Alarm off button (red signal lamp)

ON/OFF switch (1)

The appliance is switched on - the green light is on.
The appliance is switched off - the green light is off.

continued operation button (2)

This switch is used to select one of the two operation modes: continuous and automatic.

Continuous operation - the yellow light is on.

The cooling system operates continuously. This mode is selected when you want to freeze large amounts of fresh foods and in case you want to deep freeze already frozen foods.

Automatic operation - the yellow light is off.

The interior temperature is controlled by the thermostat which turns the cooling system on and off. The frequency of switching the cooling system on and off depends on:

- the thermostat knob position (thermostat setting),
- how often you open the door; and
- ambient temperature.

operation control

alarm off button and the red signal lamp (3)

The sound of the alarm is switched off by pressing the Alarm Off button. The alarm goes off because of high temperature inside the freezer (red signal lamp is on), or because of the excessive dust collected at the condenser (red signal lamp is off).

Consult the Section Troubleshooting Guide

temperature selection

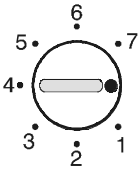

When the freezer operates automatically, the interior temperature is controlled by the thermostat.

The most suitable thermostat position is in the middle between **max (7)** and **min (1)**.

We recommend setting the thermostat on positions towards **max (7)** only in case you want to accelerate cooling, as for example before loading smaller amounts of fresh foods or when the operation mode shall correspond to the ambient temperature.

Thermostat settings towards **min (1)** help you save energy provided that the freezer is loaded with smaller amount of frozen foods.

Changes of the ambient temperature affects temperature in the interior of the appliance. Choose correct setting of the thermostat knob.

instructions for use

use

starting the empty freezer

Switch the freezer on. Sound alarm is on because of inappropriate temperature. It may be switched off by pressing the alarm button .

Put the mode selection switch to the continuous operation position. All three signal lamps are on. Place fresh food into the freezer several hours after the red signal lamp goes off.

freezing fresh foods

Proper use of the appliance, adequately packed food, correct temperature and taking into account hygienic precautions will substantially influence the quality of freezing the food or storing of the frozen foodstuffs.

- Carefully select food to be frozen: it should be of adequate quality and suitable for freezing.
- Choose correct packaging for each kind of food and pack it correctly.
- The packaging should be air tight and well sealed without leaking since this could cause substantial vitamin loss and dehydration.
- Foils and bags should be soft enough to tightly wrap around the food.
- Mark packages with following data: kind and amount of foods and the date of loading.
- It is most important that the food is frozen as quickly as possible. We therefore recommend the size of the package not to be too large and to be cooled before loading into the freezer.
- The amount of the fresh foods that can be loaded in the freezer within 24 hours is stated on the rating plate. If the loaded amount is too large, the quality of freezing is reduced which affects the quality of frozen foods.

proper freezing procedure

Freeze the food in the freezing compartment (see Section Description of the Appliance)

- 24 hours prior freezing of fresh food switch the

use

- continued operation button (2) to the uninterrupted operation (yellow lamp is on). At the end of this period load fresh food into the freezing compartment.
- After 24 hours move the frozen food to the storage compartment of the freezer and repeat the freezing procedure with new load if required. Fresh food should not touch the already frozen packages.
 - Approximately 24 hours after the last loading of fresh food press the continued operation button again (2) and switch to the automatic operation (yellow signal lamp is off).
 - In case of freezing minor quantities of fresh food (1-2 kg), it is not necessary to switch the appliance to the continued operation mode (2).

storage of frozen food

Store the already frozen food in the storage compartment of the freezer. The bottom basin of the appliance is also intended for storage purposes. Storage baskets may be removed at random and food may be placed directly upon the cooling shelves.

storing commercially frozen foods

The storage time and recommended temperature for storing commercially frozen foods is indicated on the packaging. For storing and use consider manufacturer's instruction.

When shopping, be careful and choose only packages of foods which are adequately packed and provided with complete data and stored in freezers where the temperature is not higher than -18°C .

Do not buy packages of food wrapped with frost. This indicates that the package was thawed before at least once. Take care that packages don't start to thaw.

Temperature rise shortens the storage time of commercially frozen foods.

instructions for use

use

Approximate Storage Time of Frozen Foods

Food	Storage time (in months)											
	1	2	3	4	5	6	7	8	9	10	11	12
Vegetable								+	+	+		
Fruit										+	+	+
Braed, Pastries			+									
Milk			+									
Redy-made meals			+									
Meat: Beef										+	+	+
Veal								+	+	+		
Pork				+	+	+						
Poultry								+	+	+		
Game						+	+	+				
Minced meat				+								
Smoked sausages	+											
Fish: lean			+									
fat	+											
Offal		+										

defrosting of frozen food

Partially thawed or defrosted foods should be used as soon as possible. Cold air preserves the food but it does not destroy microorganisms which rapidly activate themselves after defrosting and make foods perishable.

Partial defrosting reduces the nutritional value of foods, especially of fruits, vegetables and ready-made meals.

maintenance and cleaning

freezer defrosting

Frost and ice layer, depositing on the inner walls of the freezer should be defrosted when 3-5 mm thick.

- 24 hours prior defrosting press the continued operation mode button (2) (yellow lamp is on) to provide extra low temperature of food inside the freezer. After this period take the food out and protect them from melting.
- Disconnect the appliance from the mains supply.
- Avoid using defrosting sprays, as they may cause damage to the plastic parts and may be hazardous to health.
- Water collected at the bottom basket of the appliance should be mopped with a sponge or highly absorbing cloth.

cleaning the appliance

Before cleaning the appliance disconnect the cable from the mains supply. Do not use abrasive cleaning agents.

- Clean the exterior of the appliances with water and liquid detergent.
- Wash the interior with lukewarm water and some vinegar.
- The air openings in the bottom rail should be cleaned or vacuumed periodically.
- Sound alarm signals the excessive dusting of the condenser. The alarm may be switched off by the alarm off button (3).

cleaning of the condenser

Dust from the condenser should be vacuumed in the following manner:

- push the finger through the opening in the bottom rail and release the fastener;
- pull the rail towards you and remove it;
- remove the bottom board of the kitchen cabinet;
- pull the condenser dish out;
- use the vacuum cleaner to clean the dust from the condenser;

instructions for use

maintenance and cleaning

- replace the condenser dish and the bottom rail in the opposite order.

After you have cleaned the appliance, reconnect it to the mains supply and put the food packages back to their place.

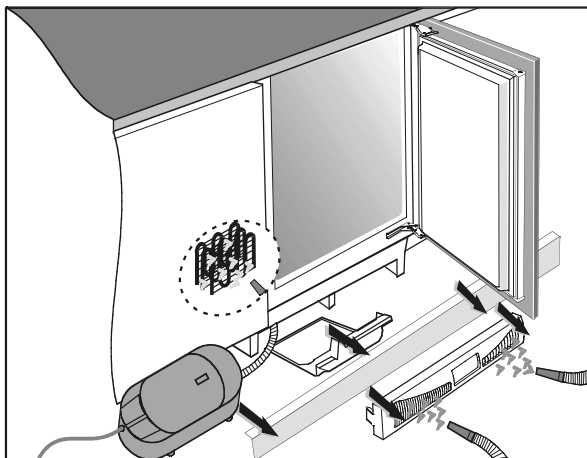

periodical cleaning of the condenser

In order to optimize the operation of the appliance and save energy, it is recommended to clean periodically the dust from the condenser at the back of the appliance.

Disconnect the appliance from the mains prior the commencement of cleaning!

- Empty the contents of the appliance.
- Remove the supporting panel from the bottom of the kitchen cabinet.
- Remove the screws fixing the appliance to the kitchen worktop.
- Pull the appliance out and expose the condenser at the back of the appliance.
- Unscrew the screws from the condenser bonnet and remove the bonnet.

instructions for use

maintenance and cleaning

- Clean the dust and dirt from the condenser.

After cleaning return the appliance to its place, plug in the mains power cord and fill with food.

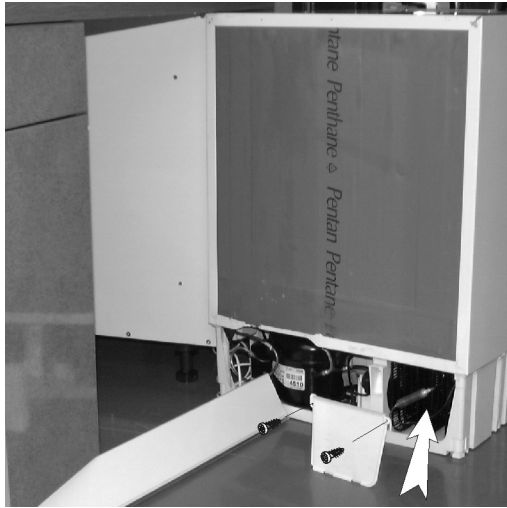

switch off the appliance when not in use

If you do not intend to use the appliance for a longer period of time, disconnect the power supply, empty the appliance, defrost it and clean it. Leave the door slightly open.

trouble-shooting guide



During the service, you can come across some troubles that in most cases result from improper handling of the appliance and can easily be eliminated.

the appliance fails to operate after connecting to the mains supply

- Check the voltage in the socket and see if the appliance is switched on (green signal lamp is on).

sound alarm, red signal lamp is on

If the temperature within the freezer is too high, it is signaled by the red signal lamp and the sound alarm, which may be switched off by pressing the alarm off button (3). When the lamp goes off the interior of the freezer has again reached the appropriate temperature. Another increase of temperature within the freezer is again signaled both by the red lamp and the sound alarm.

The reasons for this may be the following:

- The door was frequently opened or it was left opened for too long.
- The door is not properly closed (the door may sag, the gasket may be polluted or damaged).
- Power supply has been interrupted for a longer period of time.
- Perhaps you have overloaded the appliance with fresh foods.

the alarm sounds, red lamp is off

Excessive dust on the condenser or around the air circulation openings in the bottom rail may set off the sound alarm. It may be switched off by pressing the alarm off button (3).

Clean the condenser and the air circulation openings in the bottom rail (consult the Section Cleaning of the Appliance).

instructions for use

trouble-shooting guide

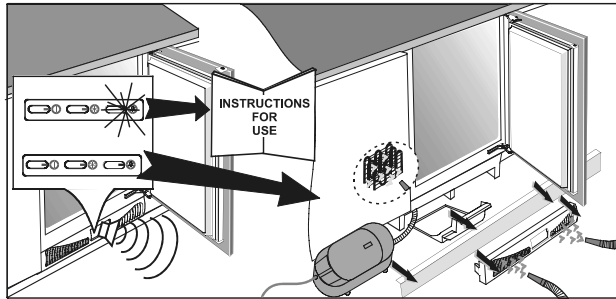

cooling system is operating continuously

- Continued operation mode is on (yellow lamp is on). Press the button (2) and switch the continued operation mode off (yellow lamp goes off).
- Insufficient cooling of compressor and condenser. This is signaled by the sound alarm. Check the air circulation through the bottom rail openings and if necessary clean or vacuum the dust from the condenser. See Section Cleaning and Maintenance.

the door is hard to open

If you want to open the door that has just or recently been closed, you may find it hard to open. The reason why this happens is, that when you open the door, warm air gets into the appliance and when it is cooling, the underpressure seals the door. After few minutes (5-10), the door can easily be opened.

noise

Cooling in refrigerating-freezing appliances is enabled by the cooling system with compressor, which produces noise. How noisy the appliance is depends on where it is placed, how it is used and how old the appliance is.

- During the operation of the compressor the noise of liquid is heard and when the compressor is not

trouble-shooting guide

operating, the refrigerant flow is heard. This is a normal condition and it has no influence whatsoever on the lifetime of the appliance.

- After starting the appliance, the operation of the compressor and the refrigerant flow may be louder, which does not mean that something is wrong with the appliance and it has no influence on the lifetime of the appliance. Gradually the noise is reduced.

WE RESERVE THE RIGHT TO ALTER THE SPECIFICATIONS WITH NO INFLUENCE ON THE OPERATION OF THE APPLIANCE.

gebruiksaanwijzing
diepvriestkast

notice d'utilisation
congélateur

gebrauchsanweisung
gefrierschrank

instructions for use
freezer

KU1090CUU



ATAG



postbus 1033 - 6920 BA - Duiven

142029 (12-08)

gba 44.01 .30.000050/f92120B