

DX6211B

DX6211F/DX6292F

DX6292K/DX6211K

manual **ATAG**



Contents

Control Panel	4
Oven Features	5
Accessories	6
Using The Accessories	7 - 8
Using This Manual	9
Safety Instructions	9 - 10
Electrical Safety	9
Safety during Operation	10
Disposal Instructions	10
Installation and Connection	11 - 12
Safety Instructions for the Installation	11
Installation in the Cabinet	11
Connecting to the Mains Power Supply	12
Before You Begin	13 - 14
Setting the Clock	13
Initial cleaning	14
Oven Use	15 - 29
Oven Modes	15
Setting the Divider Mode	16 - 17
Twin Mode	18
Single Mode	19
Setting the Oven Temperature	20
Switching the Oven Off	21
End Time	21 - 22
Cook Time	23 - 24
Delayed Start	25 - 26
Kitchen Timer	27
Oven Lamp On/Off	27
Child Safety Function	28
Switching the Beeper Off	28
Auto Cook	29
Oven Functions	30 - 41
1. Conventional	30
2. Top Heat + Convection	31
3. Convection	32
4. Large Grill	33
5. Small Grill	34
6. Bottom Heat + Convection	35
7. Twin Mode	36
8 Auto Menu Programmes for DX6211F/DX6292F	37 - 39
9 Auto Menu Programmes for DX6211B/DX6211K/DX6292K	40 - 41

Contents

EN

Cleaning and Care	42 - 53
Pyrolitic self cleaning (only for DX6211K/DX6292K).	42
Aqua cleaning	43 - 44
Rapid drying	45
Oven Interior	45
Oven Exterior	45
Stainless Steel Oven Fronts	45
Graphite Black Oven Fronts	45
Accessories	45
Cleaning the oven door.	46
Attaching the oven door	47
Oven door glass (only for DX6211B/DX6211F/DX6292F)	48
Oven door glass (only for DX6211K/DX6292K)	49 - 50
Cleaning The Telescopic Slide Guides	51
Cleaning The Top Heater (only for DX6211B/DX6211F/DX6292F).	52
Changing the Lamp.	53
Troubleshooting	54
Error and Safety Codes	55
Technical Specifications	56

Control Panel

EN

DX6211B/DX6211F/DX6292F

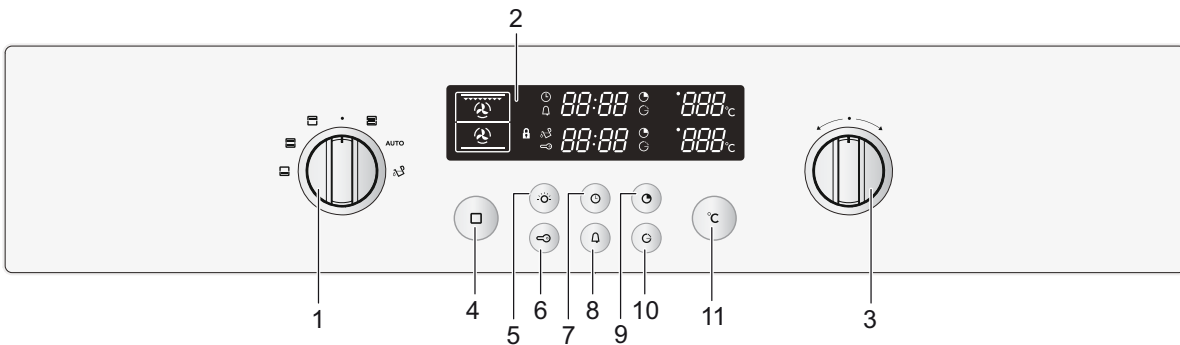

DX6211K/DX6292K

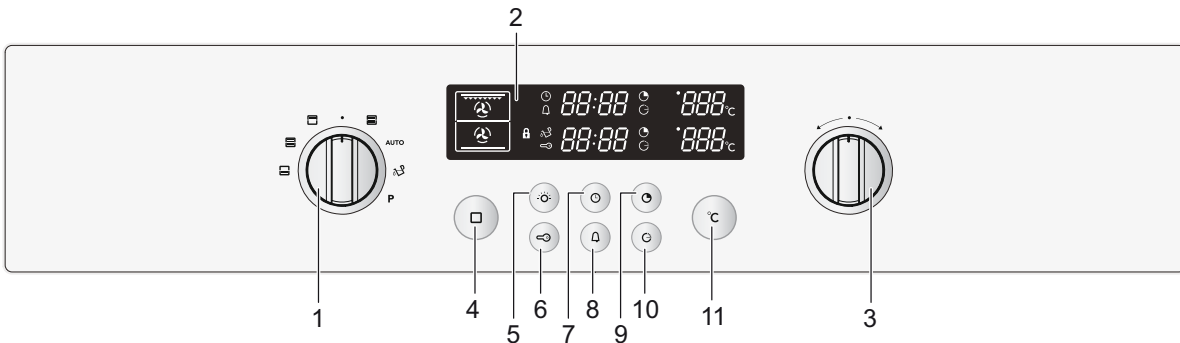

- | | |
|-----------------------------|-------------------------|
| 1. CAVITY SELECT KNOB | 7. CLOCK BUTTON |
| 2. WINDOW DISPLAY | 8. KITCHEN TIMER BUTTON |
| 3. TIME / TEMP CONTROL KNOB | 9. COOK TIME BUTTON |
| 4. OVEN FUNCTION BUTTON | 10. END TIME BUTTON |
| 5. LAMP BUTTON | 11. TEMPERATURE BUTTON |
| 6. CHILD LOCK BUTTON | |

Special features

The oven comes equipped with the following special features.

- Divider modes: when the divider inserted, the appliance's divider facility enables independent cooking in two separated partitions, enhancing energy efficiency and convenience for use.
- Aqua cleaning: the oven's self-cleaning function uses the power of steam to cut through grease and grime to clean the oven interior safely.

Oven Features

EN

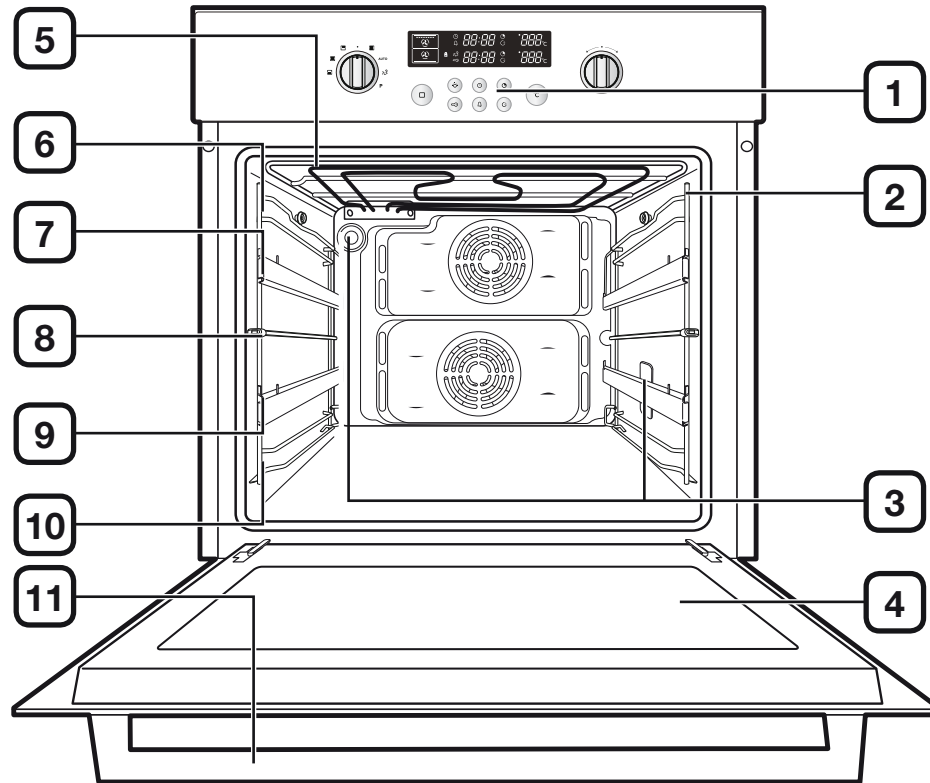

- | | |
|---------------------------|-----------------|
| 1. Control panel | 7. Level 4 |
| 2. Telescopic slide guide | 8. Level 3 |
| 3. Oven light | 9. Level 2 |
| 4. Glass door | 10. Level 1 |
| 5. Top heating elements | 11. Door handle |
| 6. Level 5 | |

Note

- Shelf levels are numbered from the bottom up.
- The levels 4 and 5 are mainly used for the grill function.
- Please refer to Cooking Guides provided throughout this booklet to determine appropriate shelf levels for your dishes.

Accessories

EN

The following accessories are provided with your oven:

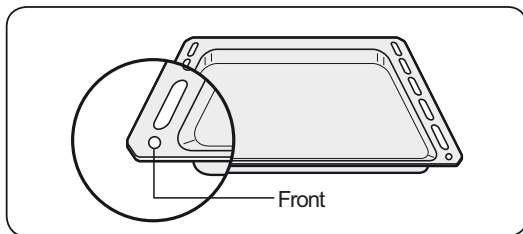

- 1** Baking tray
The baking tray could be used for the preparation of cakes, cookies and other pastries.

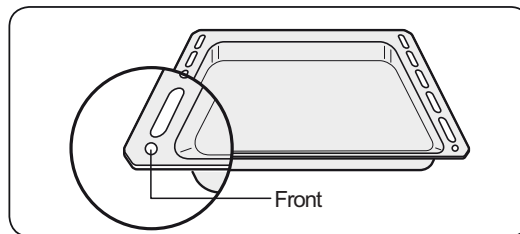

- 2** Deep baking tray
The deep baking tray should be used for roasting or collecting meat juices or fat drippings.

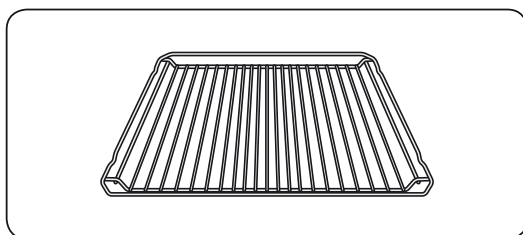

- 3** Wire rack
The wire rack should be used for dishes, cake tins, roasting and grilling trays.

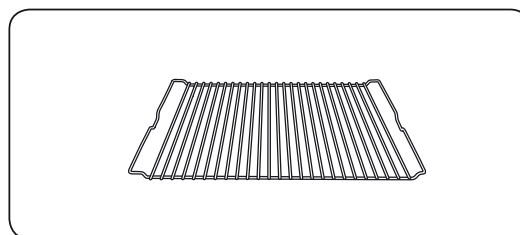

- 4** Roast wire rack
The roast wire rack should be used for roasting. Always use the roast wire rack in combination with a baking tray.

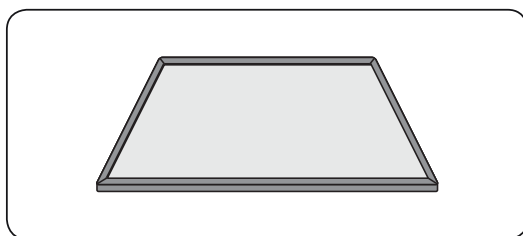

- 5** Divider, for the upper, lower and twin modes. Use inserted in level 3. There is a divider-sensing switch on the rear wall of the cooking compartment. Insert into the back completely.

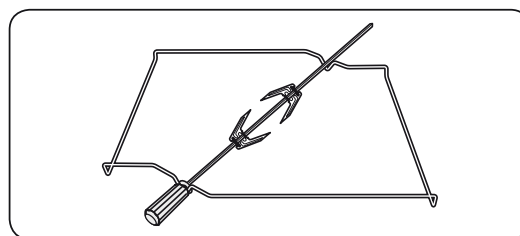

- 6** Rotisserie spit (Optional) comprises a spit, 2 prongs, a removable handle and a cradle, which fits into the 3rd shelf from the bottom. To use the rotisserie, fit the spit into the hole in the rear wall of the oven's interior. Place the deep baking tray on level 1 when using the spit.

WARNING

All accessory parts and unsuitable accessories for self cleaning should be removed for pyrolytic cleaning.

Using The Accessories

EN

Note

- When using the deep baking tray or the baking tray to collect drippings from cooking foods, ensure that the tray is properly placed in the telescopic slide guides. Allowing these accessories to contact the bottom surface of the oven can damage the enamel of the surface. Trays placed on level 1 should clear the bottom surface of the oven by at least 2 cm.
- Be very careful while removing meals and/or accessories out of the oven. Hot meals, accessories and surfaces can burn you!

Example

Level 4: baking tray

Level 1: deep baking tray

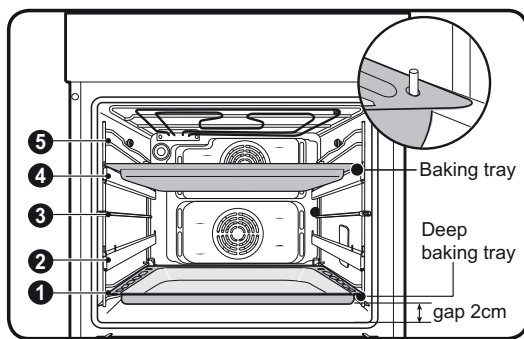

Rotisserie spit (Optional)

- Place the deep baking tray at level 1 to collect the cooking juices
- Slide one of the forks onto the spit; put the piece of meat to be roasted onto the spit;
- Parboiled potatoes and vegetables can be placed around the edge of the deep baking tray to roast at the same time.
- Place the cradle on the middle shelf and position with the 'v' shape at the front.
- To help insert the spit, the handle can be screwed onto the blunt end.
- Rest the spit onto the cradle with the pointed end towards the back and gently push until the tip of the spit enters the turning mechanism at the back of the oven. The blunt end of the spit must rest on the 'v' shape. (The spit has two lugs which should be nearest to the oven door so to stop the spit going forward, the lugs also act as a grip for the handle.)
- Before cooking unscrew the handle. After cooking screw the handle back on to help remove the spit from the cradle.

Using The Accessories (Continued)

EN

Telescopic slide guides (only for DX6211F/DX6292F)

Telescopic slide guides and other oven accessories might get very hot! Use kitchen gloves or other suitable protection! Telescopic slide guides are located inside the oven to the right and to the left in two different levels.

- To insert the baking tray or wire rack, first slide out the telescopic guides for one particular level.
- Place the tray or wire rack on the guides. Pay attention to the round holes in the baking tray (see illustration)! By placing the wire rack you must push it tight between the guides. Push them back completely into the oven. Close the oven door only after you have pushed the telescopic guides into the oven.

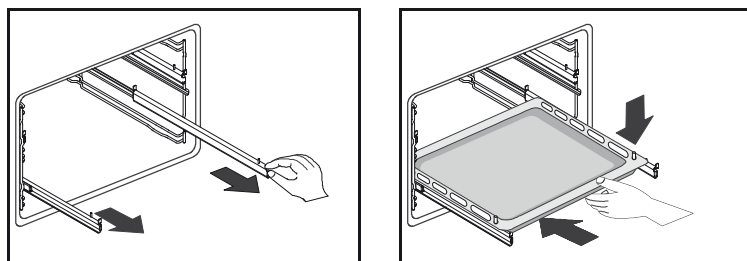

Divider, wire rack, baking tray and deep baking tray

Positioning the divider

Insert the divider into level 3 of the oven.

Positioning the wire rack

Insert the wire rack at any desired level.

Positioning the baking tray or deep baking tray

Insert the baking tray and/or the deep baking tray at any desired level.

Safety shut off

If a cooking time is not entered, the oven will shut itself off after the lengths of time indicated below.

<i>Shut off times for various temperature settings</i>	
Under 105 °C	16 hours
From 105 °C to 240 °C	8 hours
From 245 °C to 300 °C	4 hours

- This oven's electrical circuitry features a thermal shut off system. If the oven heats to abnormally high temperatures, the system will shut off the power supply to the heating elements for a period of time.

Cooling fan

During cooking, it is normal for the vent to release hot air from the front of the oven. The cooling fan will also continue to operate after the oven has been in use. It will turn off when the internal cabinet temperature has dropped to 60 °C or after 22 minutes.

Using This Manual

Thank you for purchasing an ATAG built-in oven.

Your User Manual contains important information on safety and instructions intended to assist you in the operation and maintenance of your appliance.

Before using your oven, please read all the information in this manual and keep it for future reference.

EN

Safety Instructions

Installation of this oven must be performed only by a licensed electrician. The installer is responsible for connecting the appliance to the mains power supply in observance of the relevant safety recommendations.

Electrical safety

If the oven has been damaged in transport, do not connect it.

- This appliance must be connected to the mains power supply only by a **specialty licensed electrician**.
- In the event of a fault or damage to the appliance, do not attempt to operate it.
- **Repairs** should be performed by a **licensed technician** only. Improper repair may result in considerable danger to you and others. If your oven needs repair, contact the Atag Customer Service or your dealer.
- If the supply cord is defective, it must be replaced by a special cord or assembly available from the manufacturer or an authorised service agent.
- Electrical leads and cables should not be allowed to touch the oven.
- The oven should be connected to the mains power supply by means of an approved circuit breaker or fuse. Never use multiple plug adapters or extension leads.
- The rating plate is located on the inside of the oven on the right side.
- The power supply of the appliance should be turned off when it is being repaired or cleaned.
- Take care when connecting electrical appliances to sockets near the oven.
- This appliance is not intended for use by persons (including children) with reduced physical, sensory or mental capabilities, or lack of experience and knowledge, unless they have been given supervision or instruction concerning use of the appliance by a person responsible for their safety.

WARNING

Accessible parts may become hot during use. To avoid burns, young children should be kept away.

WARNING

The appliance should be powered down before replacing the lamp to avoid the possibility of electric shock. During oven operation, the interior surfaces become very hot.

Safety Instructions (Continued)

EN

Safety during operation

- This oven has been designed only for the cooking of household foods.
- During use, the oven interior surfaces become hot enough to cause burns. Do not touch heating elements or interior surfaces of the oven until they have had time to cool down.
- Never store flammable materials in the oven.
- The oven surfaces become hot when the appliance is operated at a high temperature for an extended period of time.
- When cooking, take care when opening the oven door as hot air and steam can escape rapidly.
- When cooking dishes that contain alcohol, the alcohol may evaporate due to the high temperatures and the vapour can catch fire if it comes into contact with a hot part of the oven.
- For your safety, do not use high-pressure water cleaners or steam jet cleaners.
- Children should be kept at a safe distance when the oven is in use.
- Frozen foods such as pizzas should be cooked on the wire rack. If the baking tray is used, it may become deformed due to the great variation in temperatures.
- Do not pour water into the oven bottom when it is hot. This could cause damage to the enamel surface.
- The oven door must be closed during cooking.
- Take care when opening the door before the end of the aqua cleaning procedure; the water on the bottom is hot.
- Do not line the oven bottom with aluminium foil and do not place any baking trays or tins on it. The aluminium foil blocks the heat, which may result in damage to the enamel surfaces and cause poor cooking results.
- Fruit juices will leave stains, which can become indelible on the enamel surfaces of the oven. When cooking very moist cakes, use the deep baking tray.
- Do not rest bakeware on the open oven door.
- This appliance is not intended for use by young children or infirm persons without the adequate supervision of a responsible person ensuring that they are using the appliance safely.
- Young children should be supervised to ensure that they do not play with the appliance.
- Small amounts of food require shorter cooking or heating time. If normal times are allowed they may overheat and burn.
- Excess spillage should be removed before self cleaning and all utensils should not be left in the oven during pyrolytic self cleaning.
- During self cleaning the surfaces get hotter than usual and children should be kept a safe distance.

Disposal Instructions

Disposing of the packaging material

- The material used to package this appliance is recyclable.
- Dispose of the packaging materials in the appropriate container at your local waste disposal facility.

Disposing of old appliances

WARNING

Before disposing of old appliances, make them inoperable so that they cannot be a source of danger.

To do this, disconnect the appliance from the mains supply and remove the mains lead.

To protect the environment, it is important that old appliances are disposed of in the correct manner.

- The appliance must not be disposed of with household rubbish.
- You can obtain information about collection dates and public refuse disposal sites from your local refuse department or council.

Installation and Connection

EN

Safety instructions for the installation

This oven may be installed only by an approved electrician. The installer is responsible for connecting the appliance to the mains and in so doing for observing the relevant safety regulations.

- Ensure protection from live parts when installing the oven.
- The kitchen cabinet in which the oven is built in must satisfy stability requirements as specified in DIN 68930.

Installation in the cabinet

This is a built-in oven, which needs to be installed into an upper or lower cabinet.

- Observe the minimum distances.
- The oven should be slid into place at the proper angle of alignment.

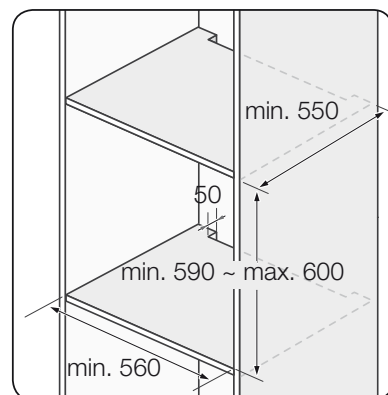
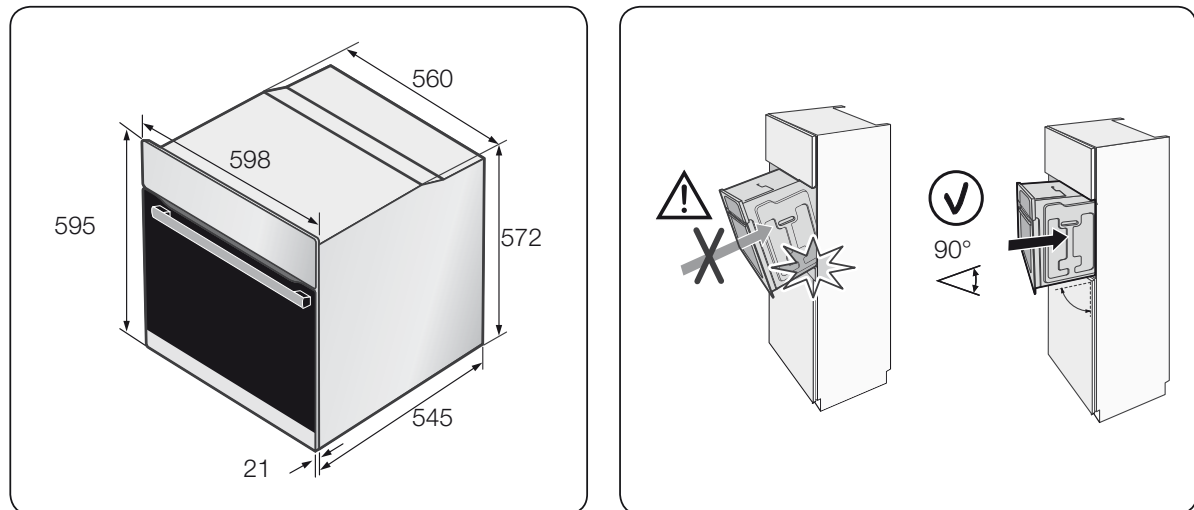

High Cabinet

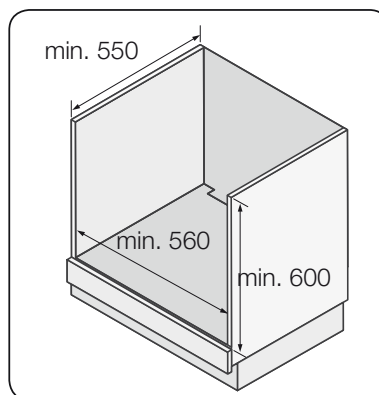

Low Cabinet

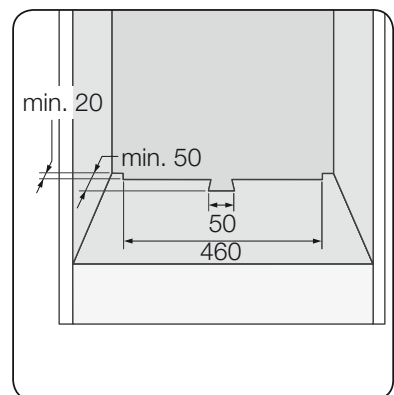

Installation and Connection (Continued)

EN

- Fix the oven on both sides using screws.
- After installation, remove the vinyl protective film from the door to the appliance and the protective film from the interior surfaces of the oven.

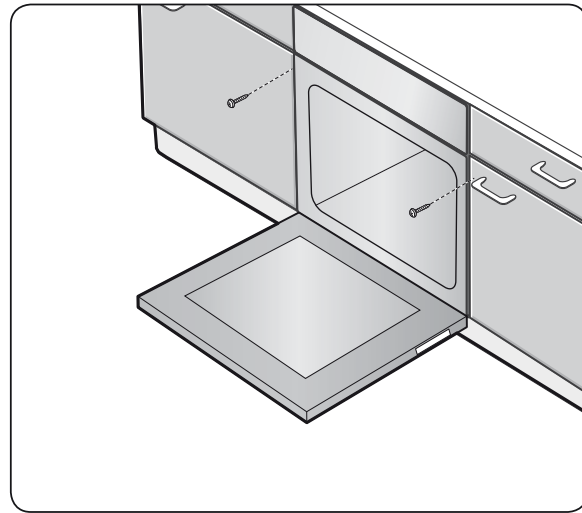

Connecting to the mains power supply

Electrical connections must be made as per the connection plate fixed to the back of the appliance by an electrical fitter who must ensure that the appliance has been connected up in accordance with fitting instructions and local regulations.

Where the appliance is not connected to the mains electricity supply by a plug, an omni polar cutout device (with a contacts gap of at least 3 mm) must be fitted on the supply side of the connection to meet safety requirements.

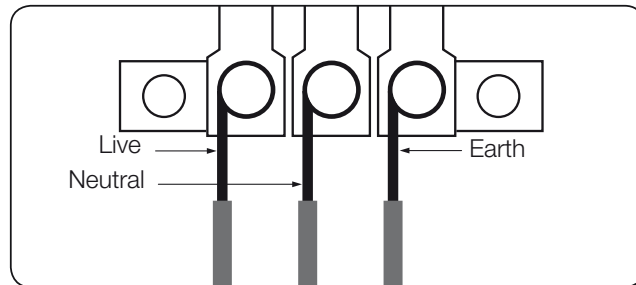

Note

When the power is connected, the electronics of the oven are initialised; this neutralizes the lighting for a few seconds. The electric cable (H05 RR-F or H05 VV-F, Min. 1.5 m, 1.5~2.5 mm²) must be long enough for it to be connected to the built-in oven standing on the floor in front of its unit.

Open the back cover of the oven at the bottom (using a flat-bladed screwdriver) and completely unscrew the connection screw and the cable clamp before fitting conducting wires into the appropriate terminals.

The earth wire must be connected to the (\equiv) terminal of the oven.

If the oven is connected to the power supply by a plug, this must remain accessible once the oven has been fitted.

We cannot accept any liability in the event of an accident resulting from non-existent or faulty earthing.

Before You Begin

EN

Setting the Clock

When power is first supplied to the oven, the display on the control panel will light briefly. After 3 seconds, you will see '12:00' in the display.

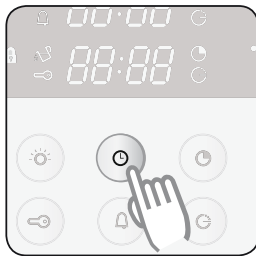

- 1** Press the **Clock Button**.
The '🕒' and '12:' will blink.

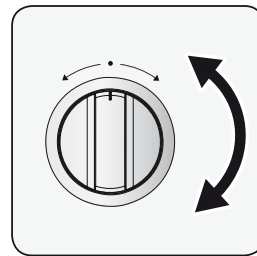

- 2** Example: to set 1:30.
Turn the **Time / Temp Control Knob** to set the hour of the day.



- 3** Press the **Clock Button**.
The '🕒' and ':00' will blink.

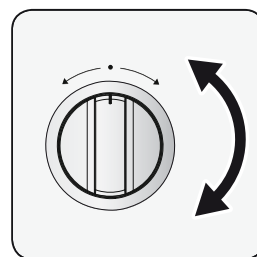

- 4** Turn the **Time / Temp Control Knob** to set the minute of the time. '🕒' will blink.



- 5** Press the **Clock Button** to finish setting the clock or wait for about 10 seconds. '🕒' will disappear and '30' will stop blinking. The display shows the time of day. The appliance is now ready to use.



Before You Begin (Continued)

EN

Initial cleaning

Clean the oven thoroughly before using for the first time.

- Do not use sharp or abrasive cleaning materials. These could damage the oven surface. For ovens with enamel fronts, use commercially available cleaning agents.

To clean the oven

1. Open the door. The oven light will light up.
2. Clean all oven trays, accessories and telescopic slide guides with warm water or washing - up liquid and polish dry with a soft clean cloth.
3. Wash the oven interior in the same way.
4. Wipe the front of the appliance with a damp cloth.

Check that the clock is set correctly. Remove accessories and operate the oven at the convection setting at 200 °C for 1 hour before using. There will be a distinctive odor; this is normal, but ensure your kitchen is well ventilated during this conditioning period.

Oven Use

EN

Oven modes

The following table represents the various oven modes and settings of your oven. Use the cooking guide tables for these modes in the following pages as guidelines for cooking.



Conventional

Food is heated by top and bottom heating elements. This setting is suitable for baking and roasting.



Top Heat + Convection

We recommend this mode when roasting meat. The top heating element is in operation and the fans operate to circulate the hot air coming from top and back wall heating element.



Convection

Food is heated by the hot air from the heating element in the back and circulated by two fans. This setting provides uniform heating and is ideal for frozen convenience food as well as cake and croissants. This mode can be used for baking on two levels.

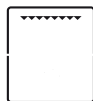

Large Grill

Food is heated by the top heating elements. We recommend this mode for grilling steaks and sausages as well as cheese toasts.

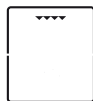

Small Grill

This mode is ideal for grilling small amounts of foods, such as baguettes, cheese or fish fillets.

Place the food in the middle of the wire grill, as only the smaller heating element in the centre is operating.



Bottom Heat + Convection

The bottom heating element and back wall heating element provide hot air which is circulated by the fans. This mode is ideal for baking food such as quiches, pizza, bread and cheesecakes.

Defrosting

This mode is ideal for defrosting frozen food by low-temperature heat and the fan. We recommend to turn over the food during the process.

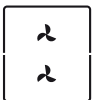

Food Item	Shelf Level	Accessory	Time (min)	Note
Chicken (1000 - 1400g)	2 1	Wire Rack + Deep Baking Tray	100~140	Turn over during defrosting
Fish (300 - 1000 g)	2 1	Wire Rack + Deep Baking Tray	50~80	
Meat (500 - 1000 g)	2	Wire Rack	50~100	
Frozen food	2	Wire Rack		



Bottom heat

This mode is ideal for browning the base of cake, pizza, quiches or pie. We recommend using this function towards the end of baking.

Oven Use (Continued)

EN

Setting the divider mode

For upper, twin and lower modes, insert the divider at the 'OFF' position of **Divider Select Knob**. For single mode, remove the divider at the 'OFF' position.

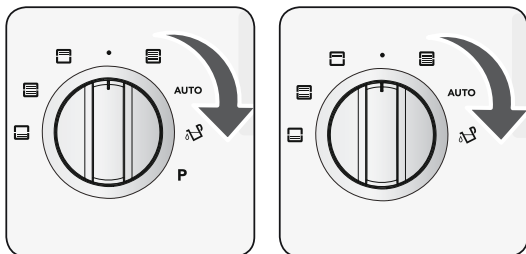

1 Turn the **Divider Select Knob** to select the desired partition.



2 Press the **Oven Function Button**.

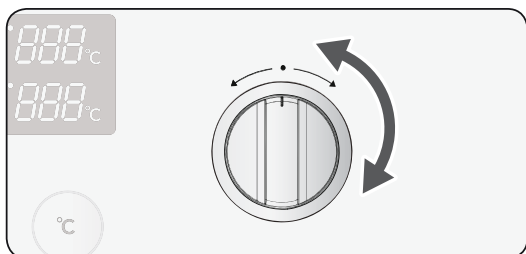

3 Turn the **Time / Temp Control Knob** to select the desired oven function. If 3 seconds have elapsed and there are no further adjustments, the oven will begin automatically in the selected mode and function.

Divider Mode	Marking	Oven Function	Insert Divider	Usage Information
Off	•			
Upper Mode		1. Convection 2. Top Heat + Convection 3. Large Grill	Yes	This mode saves energy and time when cooking small amounts of food.
Twin Mode		Both Upper and Lower Partition Function	Yes	You can cook two dishes at two different temperatures at the same time.
Lower Mode		1. Convection 2. Bottom Heat + Convection	Yes	This mode saves energy and time when cooking small amounts of food.
Single Mode		1. Convection 2. Top Heat + Convection 3. Conventional 4. Large Grill 5. Grill 6. Bottom Heat + Convection	No	
Auto	AUTO			
Steam Clean Mode			No	
Self Clean Mode (DX6211K/ DX6292K)	P	1. P1 2. P2 3. P3	No	Remove all accessories and the telescopic slide guides.

Oven Use (Continued)

EN

Upper mode

Only the upper heating element operates. The divider should be inserted.



Convection

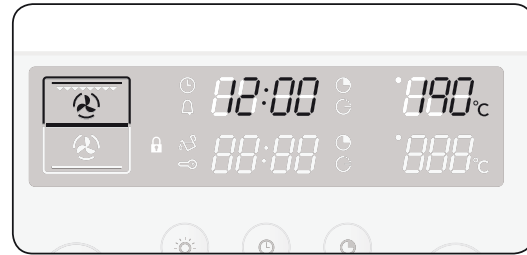

Top Heat + Convection

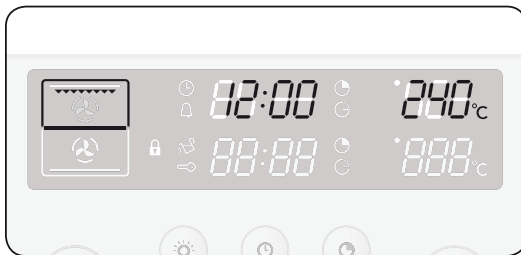

Large Grill

You can choose to operate the lower mode also after some time (see Twin mode).

Lower mode

Only the lower heating element operates. The divider should be inserted.

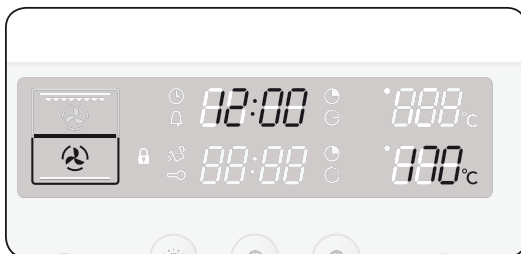

Convection

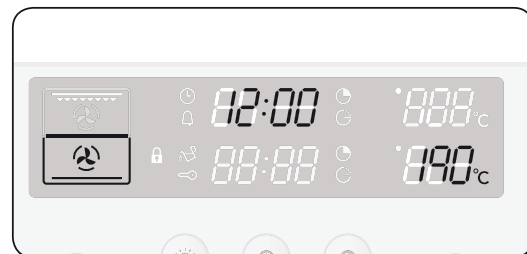

Bottom Heat + Convection

You can choose to operate the upper mode also after some time (see Twin mode).

Oven Use (Continued)

EN

Twin mode

The upper and lower modes operate at the same time. It is possible to set which mode activates first. When one of the dishes has finished cooking in twin mode and you would like to change the cooking time or temperature of the other partition, turn the **Divider Select Knob** to select the mode (upper or lower) that you would like to continue operating. Divider should be inserted.

Twin mode 1: The upper mode begins operating first. If the **Oven Function Button** is pressed or if 15 seconds elapse after the upper mode is set and there has been no further adjustment, the oven begins the lower mode.

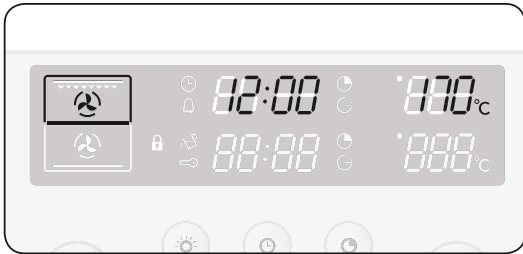

Convection



Top Heat + Convection

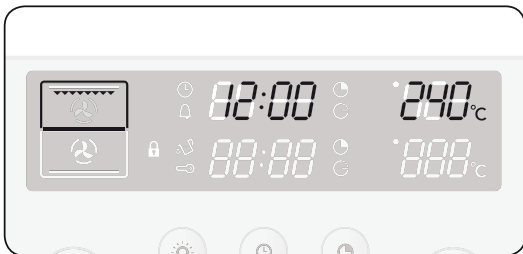

Large Grill

Twin mode 2: As the upper mode starts, if the **Oven Function Button** is pressed or if 15 seconds elapse and there has been no further adjustment, the oven moves to the lower mode. The upper and lower modes operate at the same time.

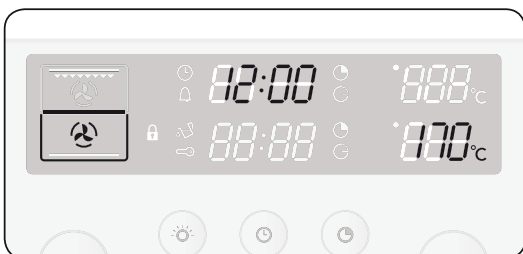

Convection

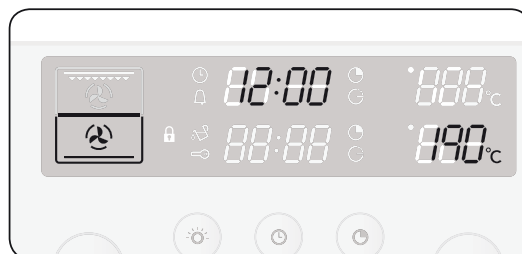

Bottom Heat + Convection

Oven Use (Continued)

EN

Single mode

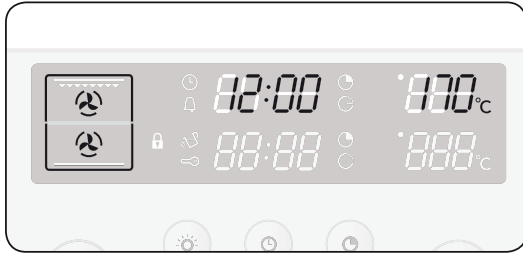

Convection

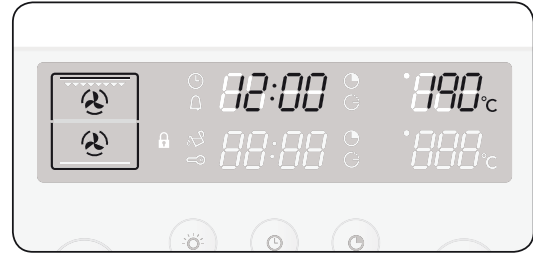

Top Heat + Convection



Conventional

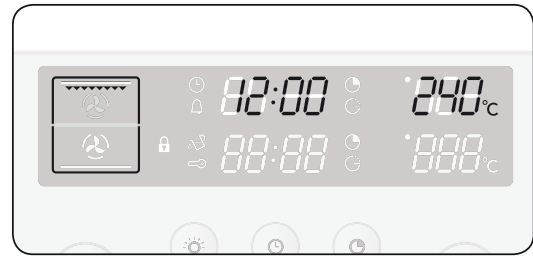

Large Grill



Grill

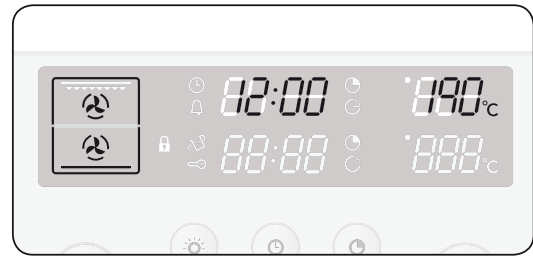

Bottom Heat + Convection

Oven Use (Continued)

EN

Setting the oven temperature

In single, upper and lower modes

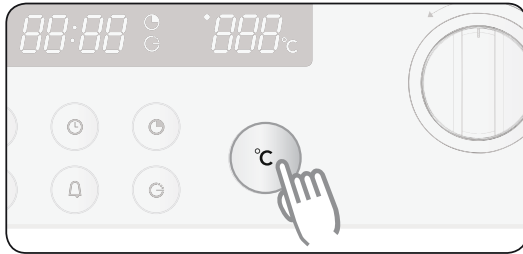

1 Press the **Temperature Button**.

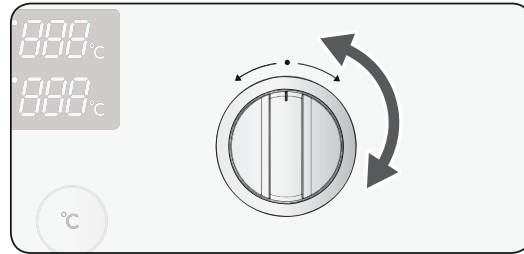

2 Turn the **Time / Temp Control Knob** to adjust the temperature in increments of 5 °C.

Single Mode (Large Grill & Grill)	40 °C – 250 °C (40 °C – 300 °C)
Upper Mode	40 °C – 250 °C
Lower Mode	40 °C – 250 °C

- The temperature may be adjusted during cooking.
- In the oven mode settings, the top and bottom heating elements cycle on and off in intervals through the cooking process to regulate and maintain the temperature.
- During the preheating of the oven, on the left side (near the temperature that is set) a 'dot' or "°C" is blinking. When the oven has reached the temperature that has been set, the 'dot' disappears or "°C" will light continuously.

In twin mode

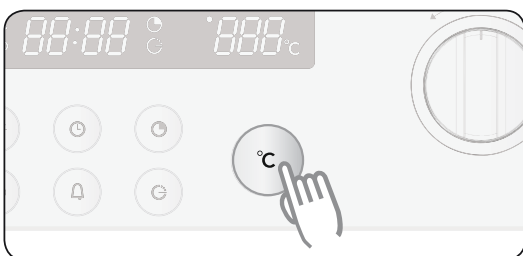

1 Press the **Temperature Button** (upper mode).
Press the **Temperature Button** twice (lower mode).

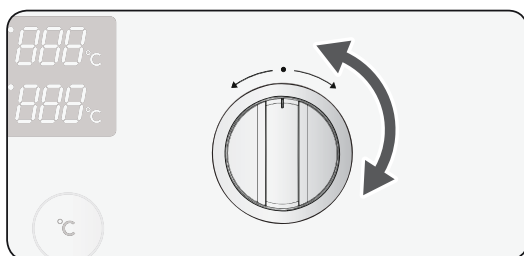

2 Turn the **Time / Temp Control Knob** to adjust the temperature in increments of 5 °C.

Twin Mode	40°C-250°C (Gap 20°C~80°C)
(Large Grill)	200°C-250°C

- The temperature may be adjusted during cooking.

Oven Use (Continued)

EN

Switching the oven off

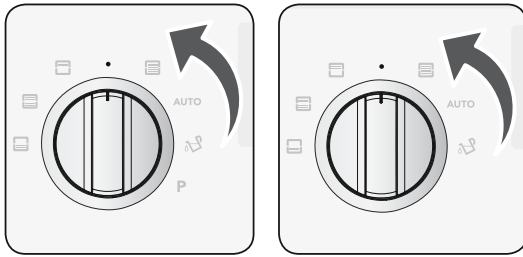

To switch the oven off, turn the **Divider Select Knob** to the 'Off' position.

End time

You can set the end time during cooking.

In single, upper and lower modes

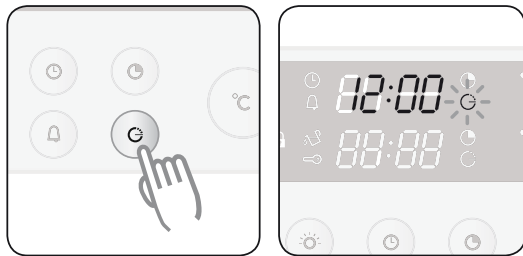

1 Press the **End Time Button**.
Example: current time is 12:00.

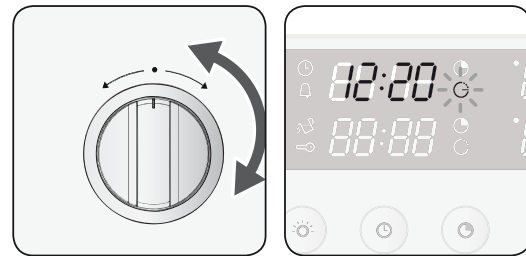

2 Turn the **Time / Temp Control Knob** to set the desired end time.

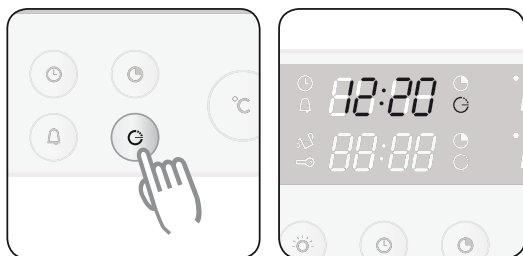

3 Press the **End Time Button**.
The oven operates with the selected end time automatically unless the **End Time Button** is pressed within 5 seconds.

- During cooking, you can adjust the previously set end time with the **Time / Temp Control Knob** for better results.

Oven Use (Continued)

EN

End time

You can set the end time during cooking.

In twin mode

End times for the upper and lower modes can be selected using the **End Time Button** and the **Time / Temp Control Knob**.

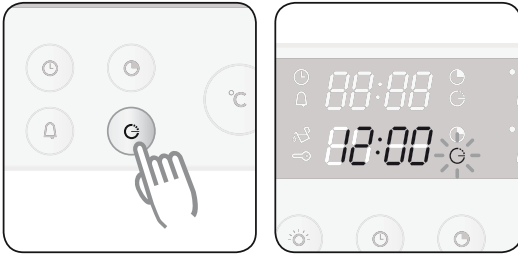

- 1** Press the **End Time Button** twice (lower mode).
Example: current time is 12:00.

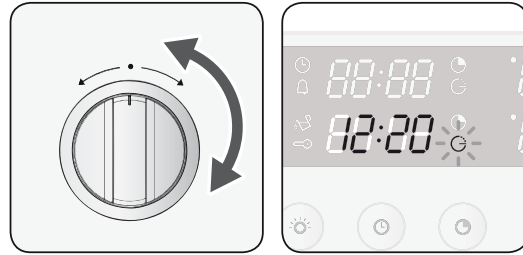

- 2** Turn the **Time / Temp Control Knob** to set the desired end time.

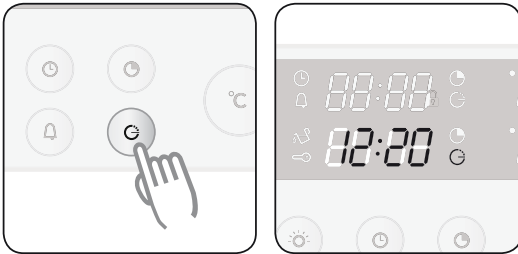

- 3** Press the **End Time Button**.
The oven operates with the selected end time unless the **End Time Button** is pressed within 5 seconds.

- During cooking, you can adjust the previously set end time with the **Time / Temp Control Knob** for better results.

Oven Use (Continued)

EN

Cook time

You can set the cook time during cooking.

In single, upper and lower modes

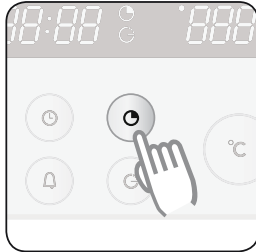

1 Press the **Cook Time Button**.

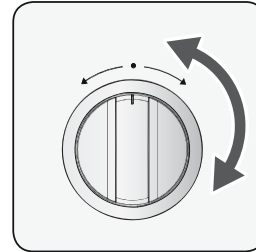

2 Turn the **Time / Temp Control Knob** to set the desired cook time.

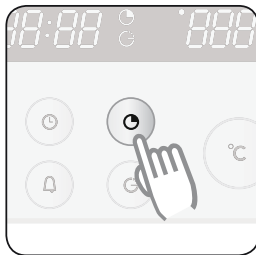

3 Press the **Cook Time Button**.
The oven operates with the selected cook time unless the **Cook Time Button** is pressed within 5 seconds.

- During cooking, you can adjust the previously set end time with the **Time / Temp Control Knob** for better results.

Oven Use (Continued)

EN

Cook time

You can set the cook time during cooking.

In twin mode

Cook times for the upper and lower modes can be selected by using the **Cook Time Button** and the **Time / Temp Control Knob**.

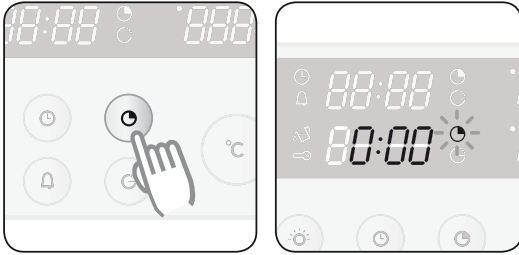

1 Press the **Cook Time Button** twice (lower mode).

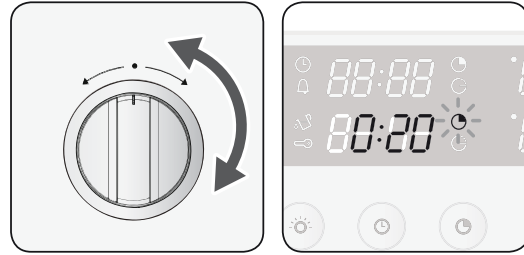

2 Turn the **Time / Temp Control Knob** to set the desired cook time.

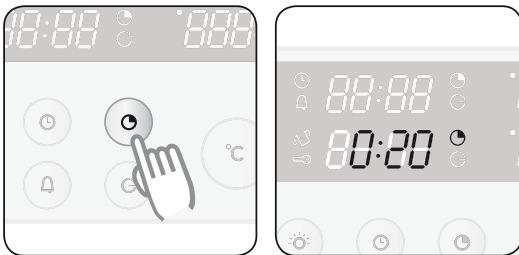

3 Press the **Cook Time Button**.
The oven operates with the selected cook time unless the **Cook Time Button** is pressed within 5 seconds.

- During cooking, you can adjust the previously set end time with the **Time / Temp Control Knob** for better results

Oven Use (Continued)

EN

Delayed start

Case 1 - Cook time is entered first

If the end time is entered after the cook time has already been set (see page 23), the cook time and the end time are calculated and if necessary the oven sets a delayed start point.

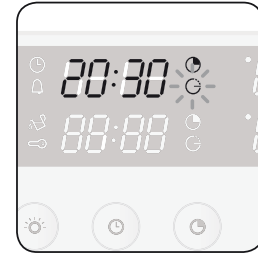
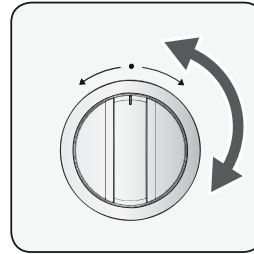
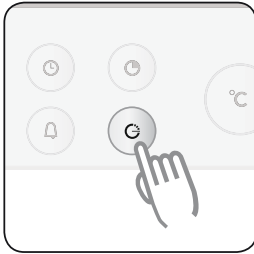

- 1** Press the **End Time Button**.
Example: current time is 15:00 and the desired cook time is 5 hours.

- 2** Turn the **Time/Temp Control Knob** to set the end time.
Example: you want to cook for 5 hours and finish at 20:30.



- 3** Press the **End Time Button**. A ' [] [] [] [] ' symbol appears until the delayed start point.

Oven Use (Continued)

EN

Delayed start

Case 2 - End time is entered first

If the cook time is entered after the end time has already been set, the cook time and the end time are calculated and if necessary the oven sets a delayed start point.

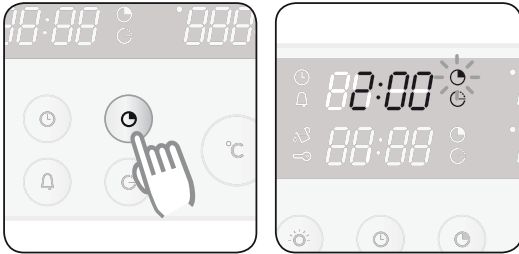

- 1** Press the **Cook Time Button**.
Example: current time is 15:00 and the desired end time is 17:00.

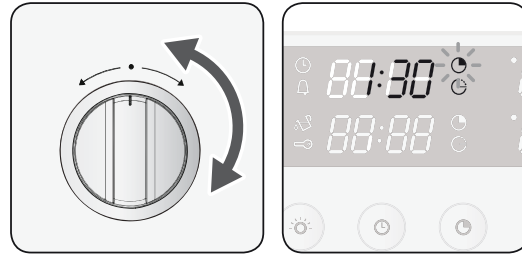

- 2** Turn the **Time / Temp Control Knob** to set the cook time.
Example: you want to cook for 1 hour and 30 minutes and end by 17:00.

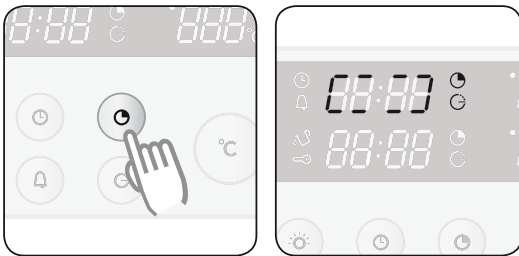



- 3** Press the **Cook Time Button**. A '00:00' symbol appears until the delayed start point.

Oven Use (Continued)

EN

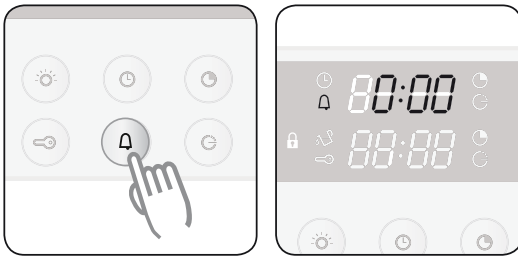
Kitchen timer



- 1 Press the **Kitchen Timer Button** once.
'An illustration showing the Time / Temp Control Knob being turned clockwise. The digital display shows 00:05 and 00:00.

- 2 Turn the **Time / Temp Control Knob** to set the desired time.
Example: 5 minutes

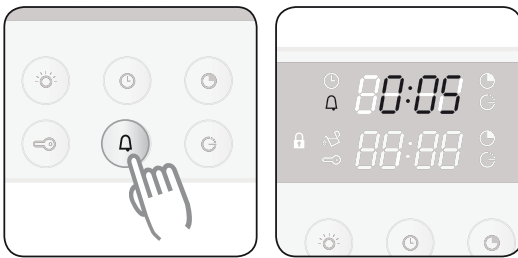

- 3 Press the **Kitchen Timer Button** to start the kitchen timer. When the set time has elapsed, an audible signal sounds.

- Press and hold the **Kitchen Timer Button** for 2 seconds to cancel the timer.

Oven lamp on/off

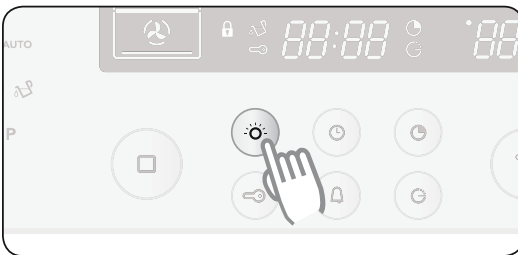

- 1 Press the **Lamp Button**.
1st Upper and Lower
2nd Upper
3rd Lower
4th Off

- Lamp turns on and off in the indicated order regardless of operation.
- The lamp automatically turns off after 2 minutes.

Oven Use (Continued)

EN

Child safety function

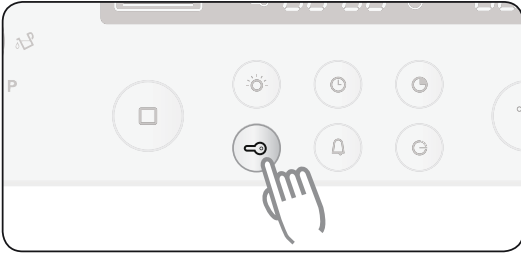

1 Press the **Child Lock Button**. Hold for 3 seconds. () will appear in the display field.

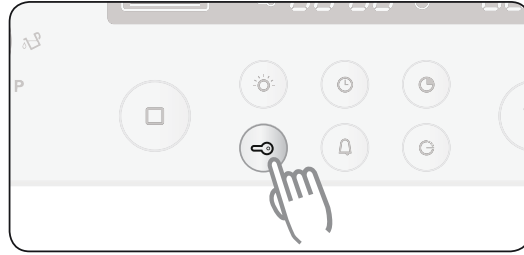

2 Press the **Child Lock Button**. Hold for 3 seconds again to unlock.

- When locked, all buttons and knobs except the **Divider Select Knob** and the **Child Lock Button** will not operate. The lock is available whether or not the oven is in operation.

Switching the beeper off

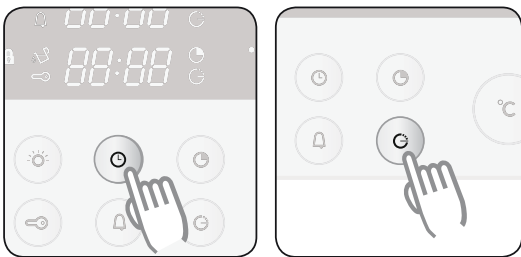

1 To turn the beeper off, press the **Clock** and **End Time Buttons** at the same time and hold for 3 seconds.

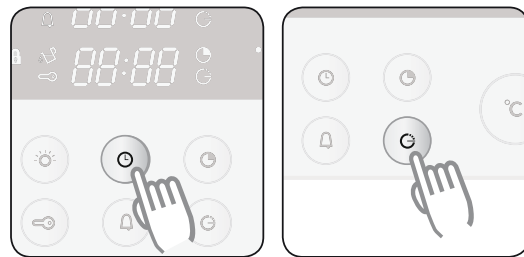

2 To turn the beeper back on, press the **Clock** and **End Time Buttons** again at the same time and hold for 3 seconds.

Oven Use (Continued)

EN

Auto Cook

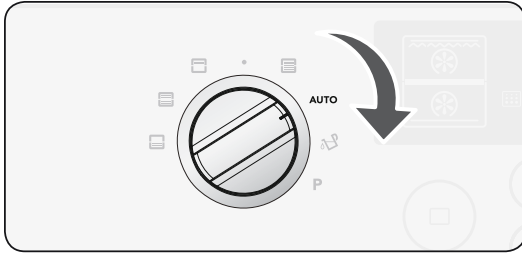

1 Turn the **Divider Select Knob** to Auto Cook.

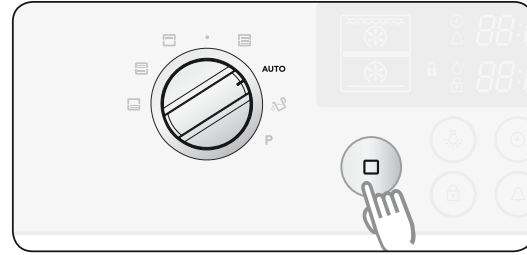

2 Press the Oven Button.

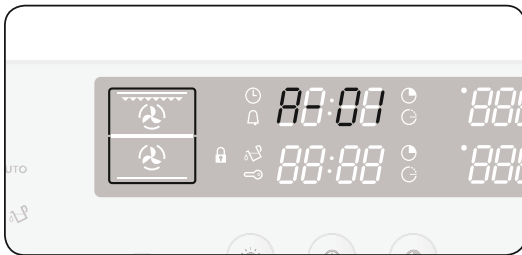

3 Select the desired recipe by turning the **Time/Temp control knob** to the right and left. Wait to select weight 5 seconds after selecting a recipe. For a recipe with weight fixed, start cooking immediately.

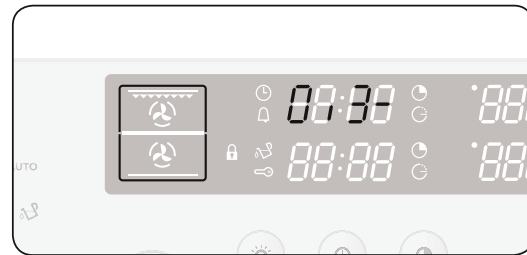

4 Select the desired weight by turning the **Time/Temp control knob** to the right and left.

- **When it reaches the time for 'Turn Over/Around'**
It beeps to inform the time for 'Turn Over/Turn Around'.

Oven Functions

EN

1. Conventional

The conventional function is ideal for baking and roasting foods arranged on one rack. Both the top and bottom heating elements operate to maintain the oven temperature.

We recommend to preheat the oven in conventional mode.

Food Item	Shelf Level	Accessory	Temperature (°C)	Time (min)
Frozen Lasagne (500-1000g)	3	Wire grill	180 - 200	40-50
Whole Fish (e.g. Dorade) (300-1000g) 3-4 cut on each side DROP OIL	3	Roast wire rack + Deep Baking tray	240	15-20
Fish filets (500-1000g) 3-4 cut on each side DROP OIL	3	Baking tray	200	13-20
Frozen cutlets (350-1000g) minced meat & with ham, cheese or mushroom filing DROP OIL	3	Baking tray	200	25-35
Frozen cutlets from minced, carrot, beetroot or potato (350-1000g) DROP OIL	3	Baking tray	200	20-30
Pork on bone cutlets (500-1000g) DROP OIL, ADD SALT & PEPPER	3 / 2	Roast wire rack / Deep baking tray	200	40-50
Baked potato (cut in half) (500-1000g)	3	Baking tray	180-200	30-45
Frozen Meat roll with mushrooms filing (500-1000g) DROP OIL	3	Baking tray	180-200	40-50
Sponge Cake (250-500g)	2	Wire grill	160 - 180	20 - 30
Marble Cake (500-1000g)	2	Wire grill	170 - 190	40 - 50
Yeast Cake on Tray with fruit & crumbles topping (1000-1500g)	2	Baking tray	160 - 180	25 - 35
Muffins (500-800 g)	2	Wire grill	190 - 200	25 - 30

Oven Functions (Continued)

2. Top Heat + Convection

EN

The top heating element is in operation and the fan operates to constantly circulate the hot air. We recommend to preheat the oven with Top Heat + Convection mode.

Food Item	Shelf Level	Accessory	Temperature (°C)	Time (min)
Pork on bone (1000g) BRUSH WITH OIL&SPICES	3	Roast wire rack + Deep baking tray	180 - 200	50-65
Pork shoulder in foil (1000-1500g) MARINATE	2	Baking tray	180 - 230	80 - 120
Whole chicken (800-1300g) BRUSH WITH OIL & SPICES	2	Roast wire rack + Deep Baking tray	190 - 200	45 - 65
Meat or fish steaks (400-800g) DROP OIL, ADD SALT & PEPPER	3	Roast wire rack + Deep baking tray	180 - 200	15 - 35
Chicken Pieces (500-1000g) BRUSH WITH OIL&SPICES	4	Roast wire rack + Deep baking tray	200 - 220	25 - 35
Roast Fish (500g-1000g) use ovenproof dish BRUSH WITH OIL	2	Wire grill	180 - 200	30 - 40
Roast Beef (800-1200g) BRUSH WITH OIL&SPICES	2	Roast wire rack + Deep baking tray Add 1 cup water	200 - 220	45 - 60
Duck Breast (300-500g)	4	Roast wire rack + Deep baking tray Add 1 cup water	180 - 200	25 - 35

Oven Functions (Continued)

EN

3. Convection

This function bakes foods placed on up to three shelves and is also appropriate for roasting. Cooking is achieved by the heating element on the rear wall and the fan distributes the heat. We recommend to preheat the oven in convection mode.

Food Item	Shelf Level	Accessory	Temperature (°C)	Time (min)
Lamb rack (350-700g) , BRUSH WITH OIL & SPICES	3	Roast wire rack + Deep baking tray	190 - 200	40-50
Baked Bananas (3-5 pcs), cut with knife on top, add 10-15g chocolate, 5-10g nuts into cuts, drop sugar water, wrap in aluminium foil.	3	Wire grill	220 - 240	15-25
Baked apples 5-8pcs each 150-200g Take out the hearts, add raisins and jam. Use ovenproof dish.	3	Wire grill	200-220	15-25
Cutlets from minced meat (300-600g) DROP OIL	3	Baking tray	190 - 200	18-25
Minced Meat roll with filling, Russian style' (500g-1000g) BRUSH WITH OIL	3	Baking tray	180-200	50-65
Frozen Croquettes (500-1000g)	2	Baking tray	180 - 200	25 - 35
Frozen Oven Chips (300-700g)	2	Baking tray	180 - 200	20 - 30
Frozen Pizza (300-1000g)	2	Wire grill	200 - 220	15 - 25
Apple & Almond Cake (500-1000 g)	2	Wire grill	170 - 190	35 - 45
Fresh Croissant (200-400g) (ready-dough)	3	Baking tray	180 - 200	15 - 25

Oven Functions (Continued)

EN

4. Large Grill

The large grill function grills large quantities of flat foods, such as steaks, schnitzels and fish. It is also suitable for toasting. Both the top heating element and the grill are on in this mode. We recommend to preheat the oven using Large Grill mode.

Food Item	Shelf Level	Accessory	Temperature (°C)	Time (min)
Sausages (thin) 5-10pcs	4	Roast wire rack + Deep baking tray	220	5 - 8 turnover 5 - 8
Sausages (thin) 8-12pcs	4	Roast wire rack + Deep baking tray	220	4 - 6 turnover 4 - 6
Toasts 5-10pcs	5	Wire grill	240	1 - 2 turnover 1 - 2
Cheese Toasts 4-6 pcs	4	Roast wire rack + Baking tray	200	4 - 8
Frozen Pancakes with filling 'Russian Style' (200- 500g)	3	Baking tray	200	20 - 30
Beef Steaks (400-800 g)	4	Roast wire rack + Deep baking tray	240	8 - 10 turnover 5-7

Oven Functions (Continued)

EN

5. Small Grill

This setting is for grilling smaller amounts of flat foods, such as steaks, schnitzels, fish and toast, placed in the middle of the tray. Only the top element is in operation. Put food in the centre of accessory.

Food Item	Shelf Level	Accessory	Temperature (°C)	Time (min)
Frozen Oven Camembert (2 – 4 each 75g) PUT IN COLD OVEN	3	Wire grill	200	10-12
Frozen Baguettes with topping (Tomato-Mozzarella or Ham & Cheese)	3	Roast wire rack + Baking tray	200	15-20
Frozen Fish fingers (300-700g) PUT IN COLD OVEN, DROP OIL	3	Roast wire rack + Baking tray	200	15-25
Frozen Fish burger (300- 600g) PUT IN COLD OVEN, DROP OIL	3	Baking tray	180-200	20-35
Frozen Pizza (300-500g) PUT IN COLD OVEN	3	Roast wire rack + Baking tray	180-200	23-30

Oven Functions (Continued)

EN

6. Bottom Heat + Convection

The Bottom Heat + Convection mode is for recipes calling for a moist topping and a crisp base, as with foods like pizzas, quiches lorraine, German-style open fruitcakes and cheesecakes. We recommend to preheat the oven in Bottom Heat + Convection mode.

Food Item	Shelf Level	Accessory	Temperature (°C)	Time (min)
Yeast dough pie with apple frozen (350-700g)	3	Wire grill	180-200	15-20
Puff pastry small pies with filling frozen (300-600g) BRUSH EGG YOLK, PUT IN COLD OVEN (before preheat),	3	Baking tray	180-200	20 - 25
Meat balls in sauce (250-500g) use ovenproof dish	3	Wire grill	180-200	25-35
Puff pastry fans (500-1000g) BRUSH EGG YOLK	3	Baking tray	180	15-23
Cannelloni in sauce (250-500g) use ovenproof dish	3	Wire grill	180	22-30
Yeast dough pies with filling (600-1000g) BRUSH EGG YOLK	3	Baking tray	180-200	20-30
Homemade Pizza (500-1000g)	2	Baking tray	200 - 220	15 - 25
Homemade Bread (700-900g)	2	Wire grill	170 - 180	45 - 55

Oven Functions (Continued)

EN

7. Twin Mode

Using twin mode you can cook two different food items in your oven. When cooking in upper and lower cavity you can use different temperatures, cooking modes and cooking times. For example, you can grill steaks and bake gratin simultaneously. Using the divider, you can cook gratin in the lower and steaks in the upper part of the oven.

Always insert the divider into shelf level 3 before you start cooking.

Suggestion 1: Cooking at different temperatures

Cavity	Food Item	Shelf Level	Cooking Mode	Temperature (°C)	Accessory	Time (min)
UPPER	Frozen Pizza (300-400g)	4	Convection	200-220	Wire grill	15-25
LOWER	Marble Cake (500-700g)	1	Convection	170 - 180	Baking Tray	50-60

Notice: Put food in cold oven

Suggestion 2: Cooking at different cooking modes

Cavity	Food Item	Shelf Level	Cooking Mode	Temperature (°C)	Accessory	Time (min)
UPPER	Chicken Pieces (400-600g)	4	Top Heat + Convection	200-220	Roast wire rack + Deep Baking tray	25-35
LOWER	Potato Gratin (500-1000g)	1	Convection	170-180	Wire Grill	30-40

Notice: Put food in cold oven

Oven Functions (Continued)

EN

8. Auto Menu Programmes for DX6211F/DX6292F

The following table presents 27 Auto Programmes for Cooking, Roasting and Baking. Those can be used in the single cavity of your oven. Always remove the divider. It contains its quantities, weight ranges and appropriate recommendations. Cooking Modes and times have been pre-programmed for your convenience. You can refer to these guide lines for cooking. Always insert food in cold oven.

No	Food Item	Weight/kg	Accessory	Shelf Level
1	Frozen Pizza	1- 0.3 - 0.4 2- 0.4 - 0.5	Wire rack	2
	Put frozen pizza in the middle of the wire rack. The first setting is for thin Italian pizza. The second setting is for thick American pizza.			
2	Frozen Oven Chips	1- 0.3 - 0.5 2- 0.6 - 0.8	Baking tray	2
	Distribute frozen Oven Chips on baking tray. The first setting is recommended for thin French fries, the second setting is recommended for thick oven chips. Use baking paper. We recommend to turn over after 2/3 of cooking time.			
3	Frozen Potato Croquettes	1- 0.3 - 0.5 2- 0.6 - 0.8	Baking tray	2
	Put frozen potato croquettes evenly on baking tray. We recommend to turnover after 2/3 of cooking time.			
4	Ready Lasagne	1- 0.3 - 0.5 2- 0.8 - 1.0	Wire rack	3
	Put ready prepared lasagne into a suitable sized ovenproof dish. Put dish in the centre of oven.			
5	Beef Steaks	1. 0.3 - 0.6 2. 0.6 - 0.8	Roast wire rack Deep baking tray	4 3
	Put 2-6 beef steaks side by side evenly on roast wire rack. The first setting is for thin steaks, the second setting is for thick steaks. Turn over after beep sounds.			
6	Roast Beef	1. 0.6 - 0.8 2. 0.9 - 1.1	Roast wire rack Deep baking tray	2 1
	Marinate Roast Beef and put on roast wire rack. Add 1 cup of water into deep baking tray. Turn over after beep sounds. After cooking wrap in aluminium foil and let stand for 5-10 min.			
7	Pork Roast	1. 0.6 - 0.8 2. 0.9 - 1.1	Roast wire rack Deep baking tray	2 1
	Put marinated roast pork on roast wire rack. Turn over, as soon as the oven beeps.			
8	Lamb Chops	1. 0.3 - 0.4 2. 0.5 - 0.6	Roast wire rack Deep baking tray	4 3
	Marinate lamb chops. Put lamb chops on roast wire rack. Turn over, as soon as the oven beeps. The first setting is for thin chops, the second setting is for thick chops.			
9	Chicken Pieces	1. 0.5 - 0.7 2. 1.0 - 1.2	Roast wire rack Deep baking tray	4 3
	Brush chicken pieces with oil and spices. Put chicken pieces side by side on the roast wire rack.			

Oven Functions (Continued)

EN

No	Food Item	Weight/kg	Accessory	Shelf Level
10	Whole Chicken	1. 1.0 - 1.1	Roast wire rack	2
		2. 1.2 - 1.3	Deep baking tray	1
Brush whole chicken with oil and spices and put on roast wire rack. Turn over, as soon as the oven beeps.				
11	Duck Breast	1. 0.3 - 0.5	Roast wire rack	4
		2. 0.6 - 0.8	Deep baking tray	3
Prepare duck breast, put on the roast wire rack with the fat-side up. First setting is for thick duck breast, the second setting is for very thick duck breasts.				
12	Roll of Turkey	1. 0.6 - 0.8	Roast wire rack	2
		2. 0.9 - 1.1	Deep baking tray	1
Put roll of turkey on the roast wire rack. Turn over, as soon as the oven beeps.				
13	Steamed Fish	1. 0.5 - 0.7	Wire rack	3
		2. 0.8 - 1.0		
Put prepared fresh fish (e.g. trout, haddock, codfish) in a suitable sized ovenproof glassware with lid. Add liquid until bottom of dish is covered e.g. 3-4 tbsp. lemon juice, white wine or water and cover with lid. Put dish on wire rack. If you prefer roasted appearance, brush skin of fish with olive oil and do not cover.				
14	Roast Fish	1. 0.5 - 0.7	Roast wire rack	4
		2. 0.8 - 1.0	Deep baking tray	3
Put fishes head to tail on the roast wire rack. First setting is for 2 fishes, the second setting is for 4 fishes. The programme is suitable for whole fishes, like trout, pikeperch or gilthead.				
15	Salmon Steaks	1. 0.3 - 0.4	Roast wire rack	4
		2. 0.7 - 0.8	Deep baking tray	3
Put salmon steaks on the roast wire rack. Turn over, as soon as the oven beeps.				
16	Oven Potatoes	1. 0.4 - 0.5	Baking tray	2
		2. 0.8 - 1.0		
Rinse potatoes, cut potatoes into halves. Brush with olive oil, herbs and spices. Distribute on the baking tray evenly. The first setting is for small potatoes (each 100g), the second setting is for large oven potatoes (each 200g).				
17	Roast Vegetables	1. 0.4 - 0.5	Deep baking tray	4
		2. 0.8 - 1.0		
Put vegetables, such as sliced courgette, pieces of pepper, sliced aubergine, mushrooms and cherry tomatoes into deep baking tray. Brush with a mixture of olive oil, herbs and spices.				
18	Vegetable Gratin	1. 0.4 - 0.6	Wire rack	2
		2. 0.8 - 1.0		
Prepare vegetable gratin using an ovenproof round dish. Put dish on wire rack in the centre of oven.				
19	Loaf Cake	1. 0.7 - 0.8	Wire rack	2

Oven Functions (Continued)

EN

No	Food Item	Weight/kg	Accessory	Shelf Level
20	Apple Pie	1. 1.2 - 1.4	Wire rack	2
	Prepare apple pie (Dutch style) in a round black metal dish with a diameter 24 cm.			
21	Bundt Cake	1. 0.5 - 0.6 2. 0.7 - 0.8 3. 0.9 - 1.0	Wire rack	2
	Put dough into a suitable sized buttered baking dish for bundt cake.			
22	Fruit Flan Base	1. 0.3 - 0.4 (large) 2. 0.2 - 0.3 (tartlets)	Wire rack	2
	The first setting is for one large fruit flan base and the second setting is for 5-6 small tartlets.			
23	Sponge Cake	1. 0.4 - 0.5 (midsize) 2. 0.2 - 0.3 (small)	Wire rack	2
	Put dough into a round black metal baking tin. First setting is for a tin with a diameter 26 cm and the second setting is for a small tin (diameter 18 cm).			
24	Muffins	1. 0.5 - 0.6 2. 0.7 - 0.8	Wire rack	2
	Put muffin dough in metal muffin dish, suitable for 12 muffins. Set dish on rack. 0.5 -0.6 kg weight range is recommended for muffins of each 45g, 0.7-0.8 kg weight range is recommended for medium sized muffins of each 65g.			
25	Bread	1. 0.7 - 0.8 (white) 2. 0.8 - 0.9 (whole meal)	Baking tray	3
	Prepare dough according to manufacturers instruction and put into a black metal rectangular baking dish (length 25 cm). The first setting is for white bread and the second setting is for wholemeal bread.			
26	Homemade Pizza	1. 1.0 - 1.2 2. 1.3 - 1.5	Baking tray	2
	Put pizza on the tray. The weight ranges include topping such as sauce, vegetables, ham and cheese. Setting 1 is for thin pizza and setting 2 is for thick pizza with much topping.			
27	Yeast dough Fermentation	1. 0.3 - 0.5 2. 0.6 - 0.8	Wire rack	2
	The first setting is recommended for rising pizza yeast dough. The second setting is suitable for yeast dough for cake and bread dough. Put into a large round heat-resistant dish and cover with cling film.			

Oven Functions (Continued)

EN

9. Auto Menu Programmes for DX6211B/DX6211K/DX6292K

The following table presents 16 Auto Programmes for Cooking, Roasting and Baking. Those can be used in the single cavity of your oven. Always remove the divider. It contains its quantities, weight ranges and appropriate recommendations. Cooking Modes and times have been pre-programmed for your convenience. You can refer to these guide lines for cooking. Always insert food in cold oven.

No	Food Item	Weight/kg	Accessory	Shelf Level
1	Frozen Pizza	1- 0.3 - 0.4 2- 0.4 - 0.5	Wire rack	2
	Put frozen pizza in the middle of the wire rack. The first setting is for thin Italian pizza. The second setting is for thick American pizza.			
2	Frozen Oven Chips	1- 0.3 - 0.5 2- 0.6 - 0.8	Baking tray	2
	Distribute frozen Oven Chips on baking tray. The first setting is recommended for thin French fries, the second setting is recommended for thick oven chips. Use baking paper. We recommend to turn over after 2/3 of cooking time.			
3	Frozen Potato Croquettes	1- 0.3 - 0.5 2- 0.6 - 0.8	Baking tray	2
	Put frozen potato croquettes evenly on baking tray. We recommend to turnover after 2/3 of cooking time.			
4	Ready Lasagne	1- 0.3 - 0.5 2- 0.8 - 1.0	Wire rack	3
	Put ready prepared lasagne into a suitable sized ovenproof dish. Put dish in the centre of oven.			
5	Beef Steaks	1. 0.3 - 0.6 2. 0.6 - 0.8	Roast wire rack Deep baking tray	4 3
	Put 2-6 beef steaks side by side evenly on roast wire rack. The first setting is for thin steaks, the second setting is for thick steaks. Turn over after beep sounds.			
6	Roast Beef	1. 0.6 - 0.8 2. 0.9 - 1.1	Roast wire rack Deep baking tray	2 1
	Marinate Roast Beef and put on roast wire rack. Add 1 cup of water into deep baking tray. Turn over after beep sounds. After cooking wrap in aluminium foil and let stand for 5-10 min.			
7	Whole Chicken	1. 1.0 - 1.1 2. 1.2 - 1.3	Roast wire rack Deep baking tray	2 1
	Brush whole chicken with oil and spices and put on roast wire rack. Turn over, as soon as the oven beeps.			
8	Steamed Fish	1. 0.5 - 0.7 2. 0.8 - 1.0	Wire rack	3
	Put prepared fresh fish (e.g. trout, haddock, codfish) in a suitable sized ovenproof glassware with lid. Add liquid until bottom of dish is covered e.g. 3-4 tbsp. lemon juice, white wine or water and cover with lid. Put dish on wire rack. If you prefer roasted appearance, brush skin of fish with olive oil and do not cover.			

Oven Functions (Continued)

EN

No	Food Item	Weight/kg	Accessory	Shelf Level
9	Loaf Cake	1. 0.7 - 0.8	Wire rack	2
	Put dough into a rectangular, buttered, black metal baking dish, with a length of 30 cm.			
10	Apple Pie	1. 1.2 - 1.4	Wire rack	2
	Prepare apple pie (Dutch style) in a round black metal dish with a diameter 24 cm.			
11	Bundt Cake	1. 0.5 - 0.6	Wire rack	2
		2. 0.7 - 0.8		
Put dough into a suitable sized buttered baking dish for bundt cake.				
12	Fruit Flan Base	1. 0.3 - 0.4 (large)	Wire rack	2
		2. 0.2 - 0.3 (tartlets)		
The first setting is for one large fruit flan base and the second setting is for 5-6 small tartlets.				
13	Muffins	1. 0.5 - 0.6	Wire rack	2
		2. 0.7 - 0.8		
Put muffin dough in metal muffin dish, suitable for 12 muffins. Set dish on rack. 0.5 -0.6 kg weight range is recommended for muffins of each 45g, 0.7-0.8 kg weight range is recommended for medium sized muffins of each 65g.				
14	Bread	1. 0.7 - 0.8 (white)	Baking tray	3
		2. 0.8 - 0.9 (whole meal)		
Prepare dough according to manufacturers instruction and put into a black metal rectangular baking dish (length 25 cm). The first setting is for white bread and the second setting is for wholemeal bread.				
15	Homemade Pizza	1. 1.0 - 1.2	Baking tray	2
		2. 1.3 - 1.5		
Put pizza on the tray. The weight ranges include topping such as sauce, vegetables, ham and cheese. Setting 1 is for thin pizza and setting 2 is for thick pizza with much topping.				
16	Yeast dough Fermentation	1. 0.3 - 0.5	Wire rack	2
		2. 0.6 - 0.8		
The first setting is recommended for rising pizza yeast dough. The second setting is suitable for yeast dough for cake and bread dough. Put into a large round heat-resistant dish and cover with cling film.				

Cleaning and Care

EN

Pyrolytic Self Cleaning (only for DX6211K/DX6292K)

This mode is for cleaning the oven automatically. It burns the leftover grease in the oven so that it can be wiped out when the oven cools down.

During the Pyrolytic Self Cleaning the oven door is locked automatically.

Door locking (🔒)	When the oven temperature heats up to 300 °C, the door will be locked automatically for safety.
Unlocking	When the oven temperature is below 260 °C, the door will be unlocked automatically.

WARNING

- During this process the oven becomes very hot.
- Children must be kept at a safe distance.

ATTENTION

Before carrying out the self cleaning function, all accessory parts should be taken out of the oven (including the telescopic slide guides, see page 51).

Remove any large pieces of dirt by hand beforehand. Because thick food residue, grease and meat juices are flammable, a fire may happen in the oven during the Self Cleaning.



1 Turn the **Divider Select Knob** to self cleaning mode.

2 Turn the **Time / Temp Control Knob** to level 1,2 or 3 according to the dirt level of oven. If 5 seconds have elapsed and there are no further adjustments, the oven will begin automatically in the selected level.

Level	Duration
P1(Low)	approx 120 minutes
P2(Medium)	approx 150 minutes
P3(High)	approx 180 minutes

3 After the oven cools down, wipe the oven door and along the edges of the oven with a damp cloth.

Cleaning and Care (continued)

EN

Aqua cleaning

- 1** Remove all accessories from the oven, including the telescopic slide guides (see page 51).
- 2** Pour approximately 400 ml (3/4 pint) of water onto the bottom of the empty oven. Use normal water only, no distilled water.
- 3** Close the oven door.
CAUTION The aqua cleaning system can be switched on only when the oven has cooled to room temperature completely. Allow the oven to cool completely if it does not work.

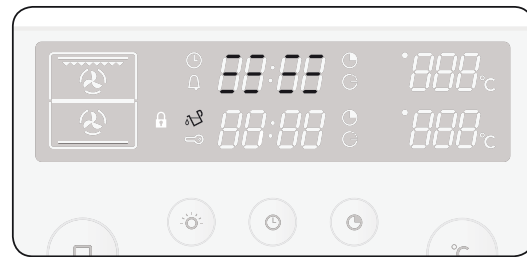
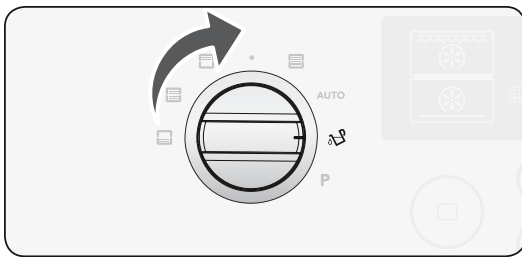

- 4** Turn the **Divider Select Knob** to aqua clean mode.

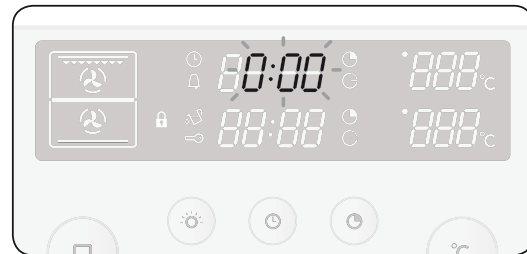
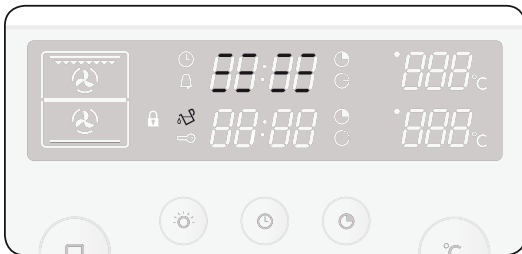

- 5** After an amount of time, the heater completes operating and its lamp remains on.
- 6** When the operation is complete, the display will blink and a beep indicates the end.

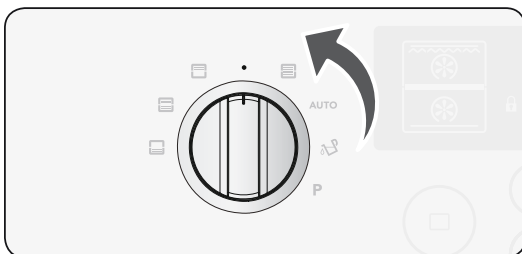

- 7** Turn the **Divider Select Knob** to 'Off' to end the operation and clean the interior.

Cleaning and Care (continued)

EN

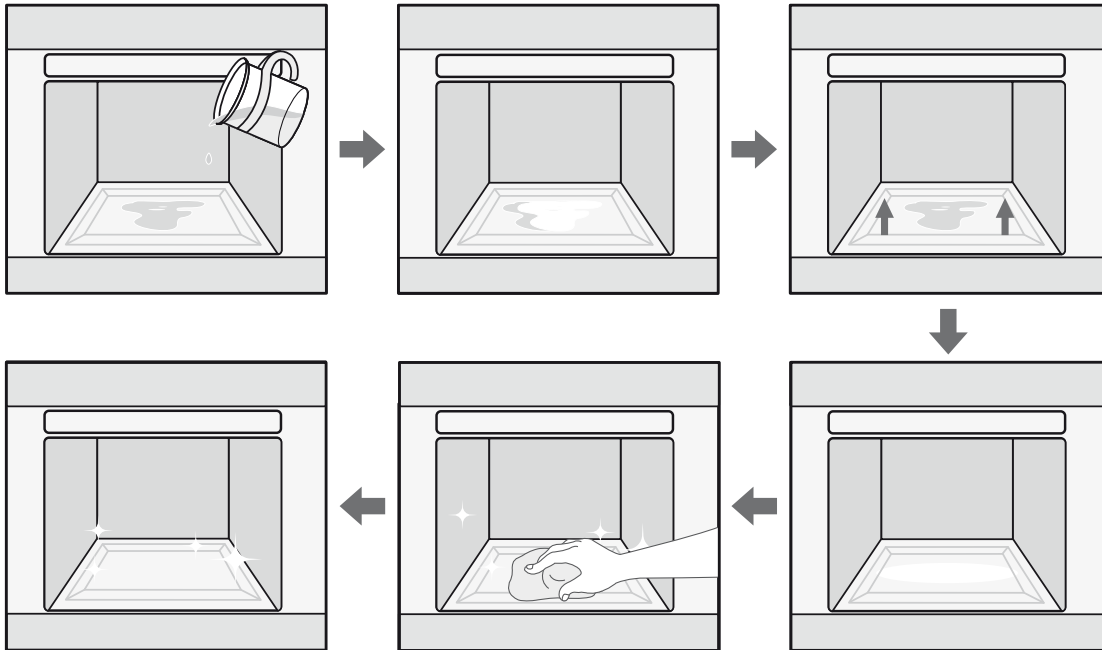

After deactivating the Aqua Cleaning

Tips

- Take care when opening the door before the end of the steam cleaning procedure; the water on the bottom is hot.
- Never leave the residual water in the oven for any length of time, for example, overnight.
- Open the oven door and remove the remaining water with a sponge.
- Using a detergent - soaked sponge, a soft brush or a nylon scrubber, wipe the oven interior. Stubborn soil can be removed with a nylon scourer.
- Lime deposits may be removed with a cloth soaked in vinegar.
- Wipe clean with clear water and dry with a soft cloth (do not forget to wipe under the oven door seal).
- If the oven is heavily soiled, the procedure may be repeated after the oven has cooled.
- If the oven is heavily soiled with grease, for example, after roasting or grilling, it is recommend that you rub detergent into the stubborn soil before activating the oven cleaning function.
- After cleaning, leave the oven door ajar at a 15 ° angle to allow the interior enamel surface to dry thoroughly.

Cleaning and Care (Continued)

EN

Warning

- Make sure the oven and accessory is cool before cleaning.
- Do not use high - pressure water cleaners or steam jet cleaners to clean the oven.

Rapid drying

1. Leave the oven door ajar at an angle of approximately 30°.
2. Turn the **Divider Select Knob** to single mode.
3. Press the **Oven Function Button**.
4. Turn the **Time / Temp Control Knob** to convection.
5. Set the cook time to about 5 minutes and the temperature to 50 °C.
6. Switch the oven off at the end of this period.

Oven interior

- For cleaning the interior of the oven, use a clean cloth and a mild cleaning agent or warm soapy water.
- Do not hand-clean the door seal.
- Do not use scouring pads or cleaning sponges.
- To remove stubborn soil, use a special oven cleaner.
- The cover casing should be cleaned using hot water, detergent and a soft nylon brush.
- Do not use abrasive cleaning agents, hard brushes, scouring pads or cloths, steel wool, knives or other abrasive materials.

Oven exterior

- For cleaning the exterior of the oven, use a clean cloth and a mild cleaning agent or warm soapy water.
- Dry with kitchen roll or a dry towel.
- Do not use scourers, caustic cleaners or abrasive products.

Stainless steel oven fronts

- Do not use steel wool, scouring pads or other abrasives. They may damage the finish.

Graphite black oven fronts

- Wipe the surface gently with a soft clean cloth or microfiber cloth and a mild window cleaning detergent.

Accessories

- Wash the accessories after every use and dry them with a kitchen towel. If necessary, lay in warm soapy water for about 30 minutes for easier cleaning.

Cleaning and Care (Continued)

EN

Cleaning the oven door

For normal use, the oven door should not be removed but if removal is necessary, for example, for cleaning, follow these instructions. The oven door is heavy.

Removing the door

1. Flip open the clips at both hinges.

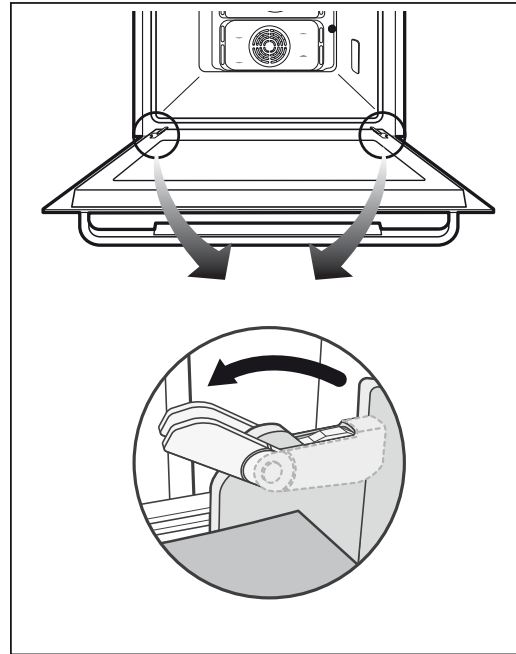

2. With both hands, grasp the sides of the oven door at its middle.
3. Rotate the door by approximately 70° until the hinges can be taken out completely from the hinge holes.

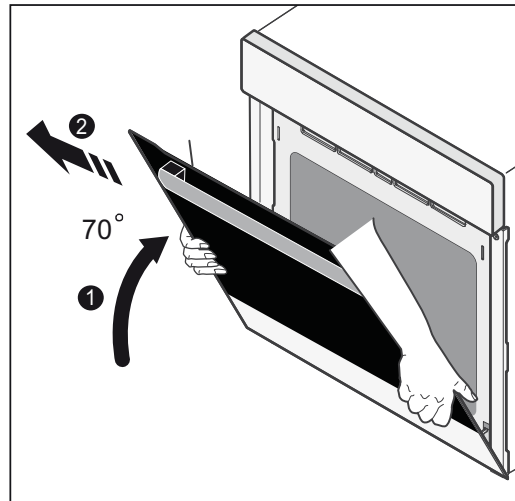

Cleaning and Care (Continued)

Attaching the door

EN

1. With the clips still flipped open, align the door hinges into the hinge holes.

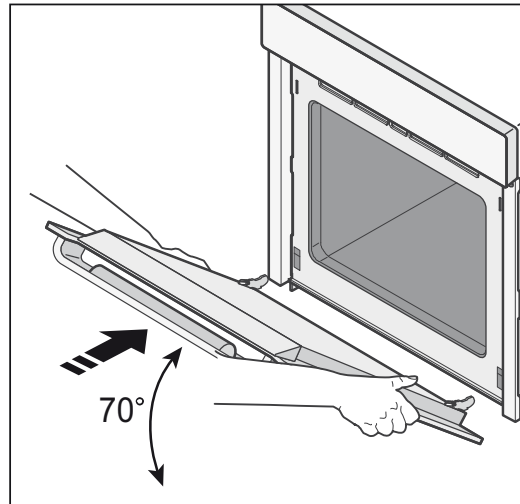

2. Rotate the door toward the horizontal line and flip the clips closed.

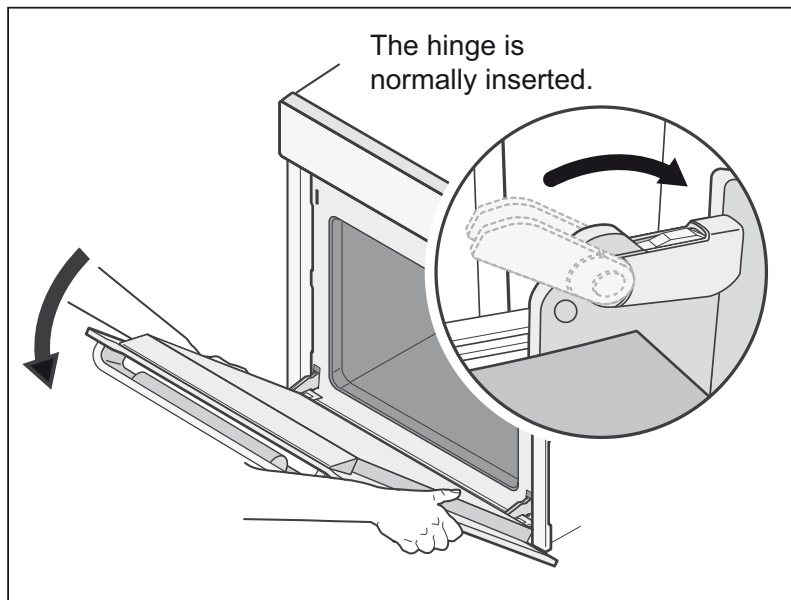
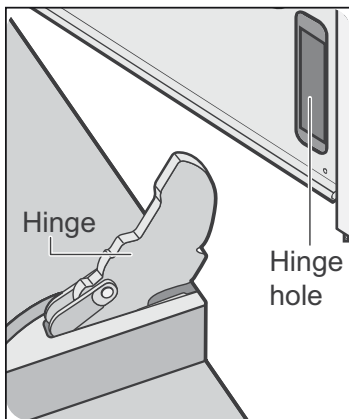

Cleaning and Care (continued)

EN

Oven door glass (only for DX6211B/ DX6211F/DX6292F)

The oven door is equipped with three sheets of glass placed against each other. The inner & middle sheets can be removed for cleaning.

WARNING:

- Whenever the door is separated from the oven, the clips should be flipped open.
- Do not use harsh abrasive cleaners or metal scrapers to clean the oven door; they can scratch the surface, which may cause the glass to shatter.
- When the door is mounted, removing some of the parts (the door glass or some other part) from the door may result in injury.

ATTENTION: The glass may break if you use excessive force especially at the edges of the front sheet.

Door glass removal

The oven door is equipped with three sheets of glass placed against each other. These sheets can be removed for cleaning.

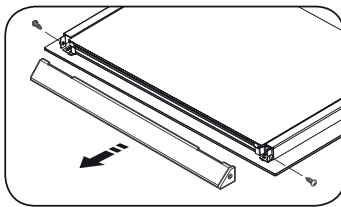

- 1** Remove the two screws on the left and right sides of the door.

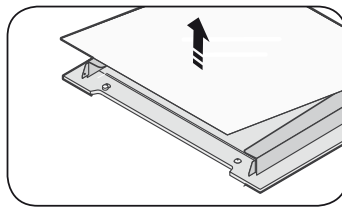

- 2** Detach the covering and remove glass 1 from the door.

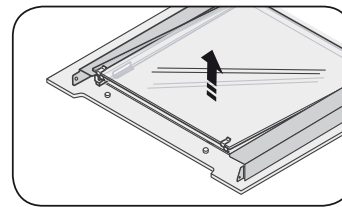

- 3** Lift glass 2 and remove the two holder glass rubbers from the top of the sheet. Clean the sheets with warm water or washing-up liquid and polish dry them with a soft clean cloth.

Door glass attaching

Repeat steps 1,2 and 3 in reverse order.

- When assembling the inner glass 1, put printing to the lower direction.

Cleaning and Care (Continued)

EN

Oven door glass (only for DX6211K/DX6292K)

The oven door is equipped with four sheets of glass placed against each other. The inner & middle sheets can be removed for cleaning.

WARNING

- Whenever the door is separated from the oven, the clips should be flipped open.
- Do not use harsh abrasive cleaners or metal scrapers to clean the oven door; they can scratch the surface, which may cause the glass to shatter.
- When the door is mounted, removing some of the parts (the door glass or some other part) from the door may result in injury.

ATTENTION

The glass may break if you use excessive force especially at the edges of the front sheet.

Disassembling the door

1. Remove the two screws on the left and right sides of the door.
2. Take off the door bracket.

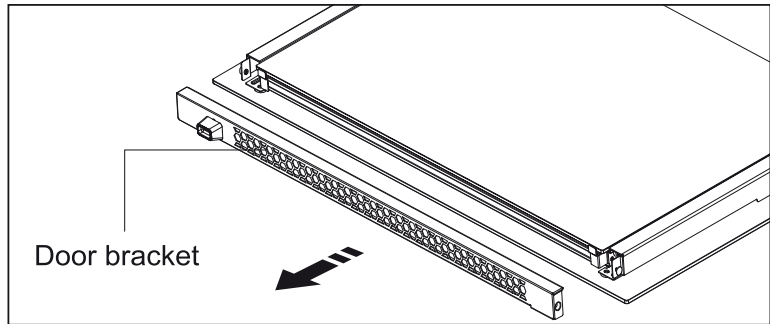
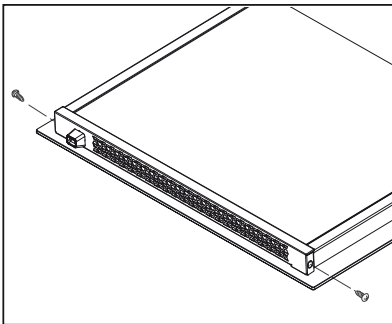

3. Detach the inner glass #1 from the door.

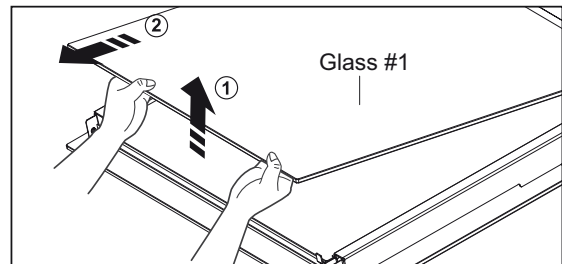

4. Detach the inner glass #2 and spring-brackets from the door.

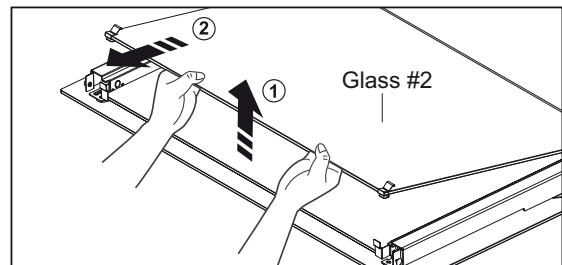

Cleaning and Care (Continued)

EN

5. Detach the glass #3 from the door

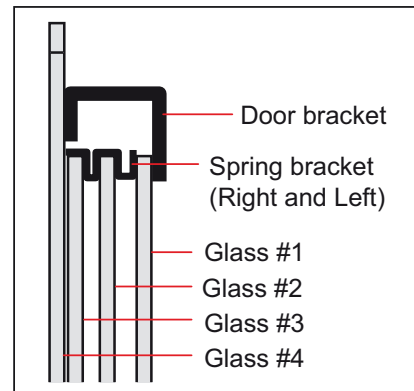
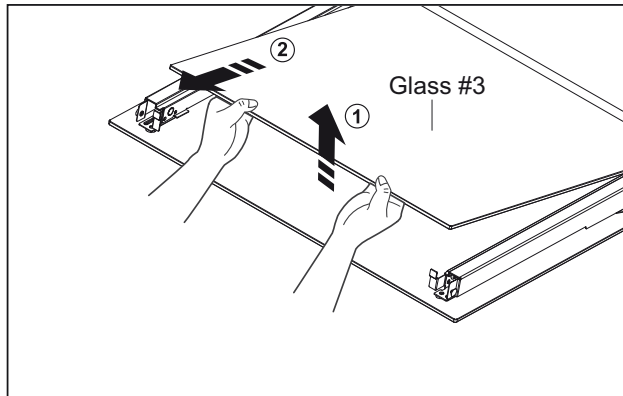

- Clean the sheets with warm water or washing-up liquid and polish dry with a soft clean cloth.

Assembling the door

1. Clean the glass and interior parts with warm soapy water.
 - Do not use abrasive cleaners or pan scourers. Use a sponge with liquid detergent or warm soapy water.
2. Attach the glass #3 into position.
3. Attach the two spring brackets at the top of glass #2 and place glass #2 into position.
4. Attach glass #1, the door bracket to the door.
5. Secure the two screws at both sides of the door.

Cleaning and Care (Continued)

Telescopic slide guides

To clean the interior of the oven, the Telescopic slide guides can be removed.

EN

Detaching the Telescopic slide guides

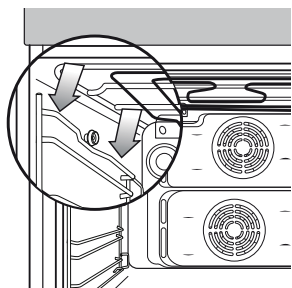

- 1** Press central part of the telescopic slide guide top portion.

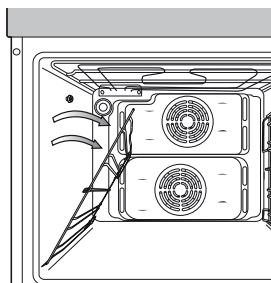

- 2** Rotate the telescopic slide guide by approximately 45°.

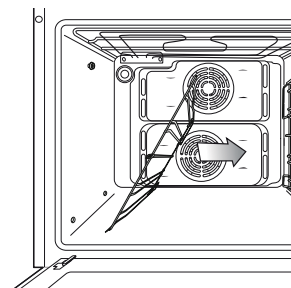

- 3** Pull the telescopic slide guide out of the two holes in the bottom and remove the telescopic slide guide.

Attaching the Telescopic slide guides

Repeat steps 1,2 and 3 in reverse order.

Cleaning and Care (Continued)

EN

Cleaning the top heater (only for DX6211B/ DX6211F/DX6292F)

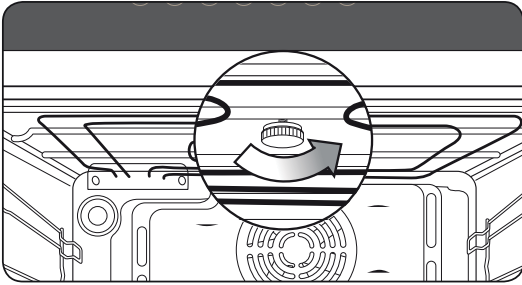

- 1** Remove the upper nut circular by turning it anti-clockwise while holding the top of the heater.

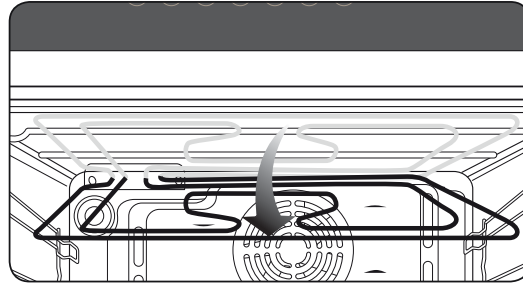

The front of the top heater inclines downwards.

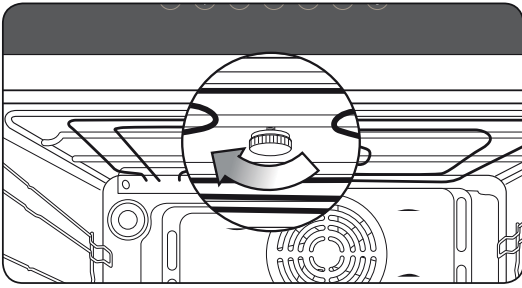

- 2** When the cleaning has been done, lift the top of the heater back to its original level and turn the nut circular clockwise.

Cleaning and Care (Continued)

EN

Changing the lamp

- **Danger of electric shock!**

Before replacing any of the oven light bulbs, take the following steps:

- Switch off the oven.
- Disconnect the oven from the mains supply.
- Protect the oven light bulb and the glass cap by laying a cloth on the bottom of the oven compartment.
- Bulbs can be purchased from the ATAG Customer Service.

Replacing the rear oven lamp and cleaning the glass cap

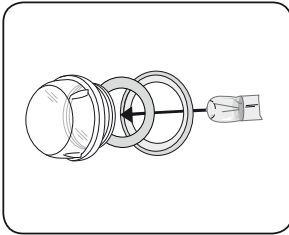
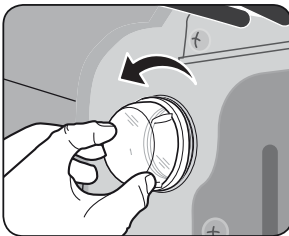

1. Remove the cap by turning anticlockwise and remove the metal ring, the sheet ring and clean the glass cap. If necessary, replace the bulb with a 25 ~ 40 watt, 230 V, 300 °C heat-resistant oven light bulb.
2. Clean the glass cap, the metal ring and the sheet ring if necessary.
3. Fit the metal and the sheet ring to the glass cap.
4. Place the glass cap where you have removed it in step 1 and turn it clockwise to keep it in place.

Replacing the oven side lamp and cleaning the glass cap

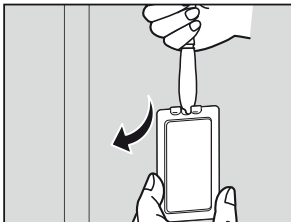

1. To remove the glass cover, hold the lower end with one hand, insert a flat sharp implement such as a table knife between the glass and the frame and pop out the cover.
2. If necessary, replace the halogen bulb with a 25 ~ 40 watt, 230 V, 300 °C heat - resistant halogen oven light bulb.

Tip

- Always use a cloth when handling a halogen bulb to avoid depositing oils from your fingers on to the surface of the bulb.
3. Replace the glass cover.

Troubleshooting

EN

If you have problems with your oven, try the solutions suggested below. They may save you the time and inconvenience of an unnecessary service call.

What should I do if the oven doesn't heat up?

Check to see if one of the following actions resolves the issue:

- The oven may not be switched on. Switch the oven on.
- The clock may not be set. Set the clock (see section 'Time setting').
- Check to see if the required settings have been applied.
- A household fuse may have blown or a circuit breaker may have tripped. Replace the fuses or reset the circuit. If this happens repeatedly, call an authorised electrician.

What should I do if, even though the oven function and temperature have been set, the oven does not heat up?

There may be problems with the internal electrical connections. Call your local service centre.

What should I do if an error code appears and the oven does not heat up?

There is a fault in the internal electrical circuit connection. Call your local service centre.

What should I do if the time display is blinking?

There was a power failure. Set the clock (see section 'Setting the clock').

What should I do if the oven light doesn't illuminate?

The oven light is faulty. Replace the oven light bulb (see section 'Changing the lamp').

What should I do if the oven's fan is running without having been set?

Following use, the oven's fan runs until the oven has cooled down. Call your local service centre if the fan continues to run after the oven has cooled down.

Error and Safety Codes

EN

Error Code

General Functions

E-27

TEMP SENSOR ERROR

E-26

E-28

E-2C

S-01

SAFETY SHUTOFF

Oven has continued operating at set temperature for prolonged time.

Turn the oven off and remove food. Allow the oven to cool down before using again.

E-09

An error of the oven may cause low performance and problems in safety. Stop using the oven immediately.

E-0A

E-0B

-SE-

E-0b

PARTITION MISSING

EE-

The usage of the divider is not correct. Refer to the '**Setting the divider mode**' (see page 16).

For upper, twin and lower mode, the divider should be inserted, and for single mode, the divider should be eliminated.

If any of these errors occur, please contact ATAG Customer Service.

Technical Specifications

EN

Model	DX6211B/DX6211F/DX6292F	DX6211K/DX6292K
Power Source	230 V ~ 50 Hz	230 V ~ 50 Hz
Output Rating	max. 3650 W	max. 3650 W
Dimensions (W x H x D) Outside Oven cavity net.	598 x 595 x 566 mm 440 x 365 x 405 mm	598 x 595 x 566 mm 440 x 365 x 405 mm
Volume (usable capacity)	65 L	65 L
Weight Net Shipping	39/40/40 kg approx 44.5/45.5/45.5 kg approx	47 kg approx 53.5 kg approx

English



Correct Disposal of This Product (Waste Electrical & Electronic Equipment)

(Applicable in the European Union and other European countries with separate collection systems)

This marking on the product, accessories or literature indicates that the product and its electronic accessories (e.g. charger, headset, USB cable) should not be disposed of with other household waste at the end of their working life. To prevent possible harm to the environment or human health from uncontrolled waste disposal, please separate these items from other types of waste and recycle them responsibly to promote the sustainable reuse of material resources.

Household users should contact either the retailer where they purchased this product, or their local government office, for details of where and how they can take these items for environmentally safe recycling.

Business users should contact their supplier and check the terms and conditions of the purchase contract. This product and its electronic accessories should not be mixed with other commercial wastes for disposal.

Note



EN

Note



EN

Note



EN



Het toestel-identificatieplaatje bevindt zich aan de binnenkant van het toestel.
La plaque d'identification de l'appareil se trouve sur l'intérieur de l'appareil.
Das Gerätetypenschild befindet sich an der Innenseite des Gerätes.
The appliance identification card is located on the inside of the appliance.

Plak hier het toestel-identificatieplaatje.
Placez ici la plaque d'identification de l'appareil.
Kleben Sie hier das Gerätetypenschild ein.
Stick the appliance identification card here.

Houd, wanneer u contact opneemt met de serviceafdeling,
het complete typenummer bij de hand.
En cas de contact avec le service après-vente,
ayez auprès de vous le numéro de type complet.
Halten Sie die vollständige Typennummer bereit,
wenn Sie mit der Kundendienstabteilung Kontakt aufnehmen.
When contacting the service department, have the complete type number to hand.

Adressen en telefoonnummers van de serviceorganisatie vindt u op de garantietaart.
Les adresses et les numéros de téléphone du service après-vente se trouvent sur la carte de garantie.
Adressen und Telefonnummern der Kundendienstorganisation finden Sie auf der Garantiekarte.
You will find the addresses and phone numbers of the service organisation on the guarantee card.

Code No.: DG68-00245F