

2002

2027

2028

2036

2034

2023

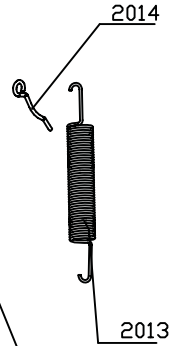
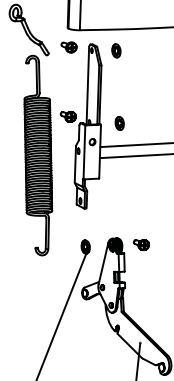
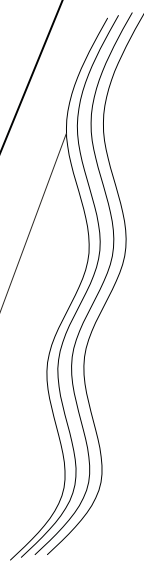
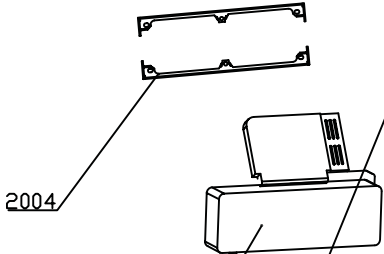
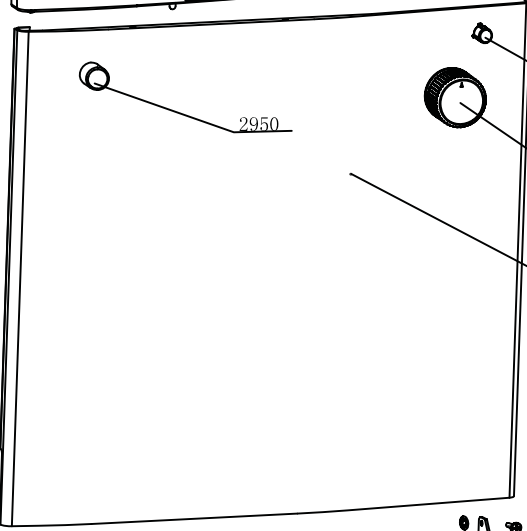
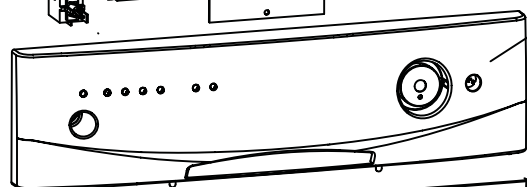
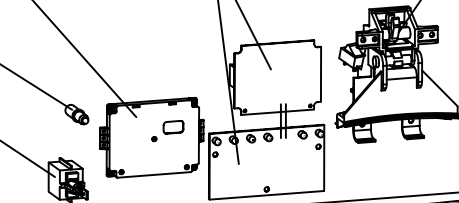
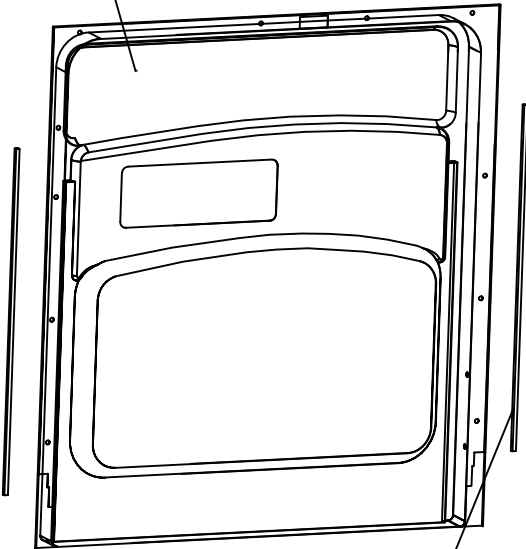

2004

2005

2001

2006

2008

2009

2010

2011

2013

2012

2018

2952

2019

2017

2950

2014

