

322

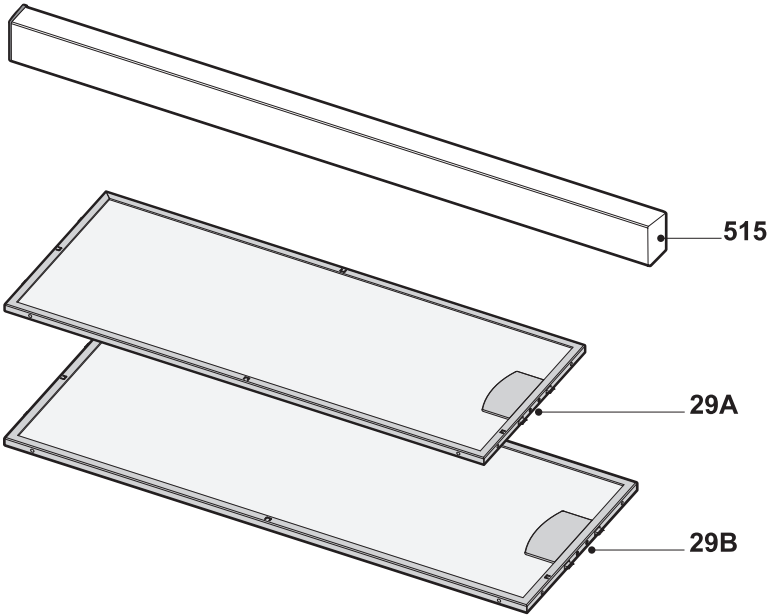

481

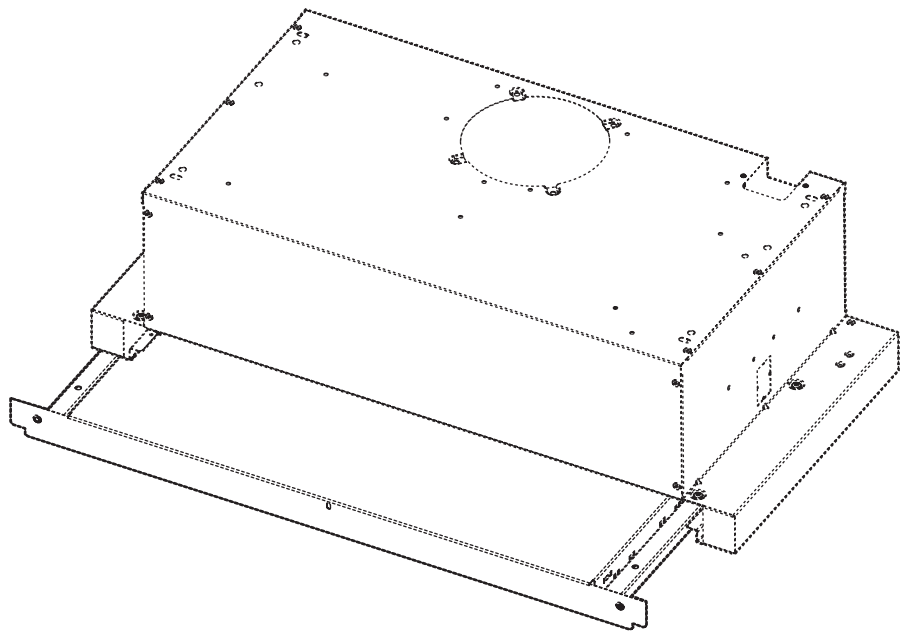
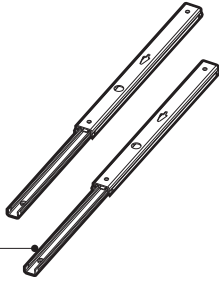
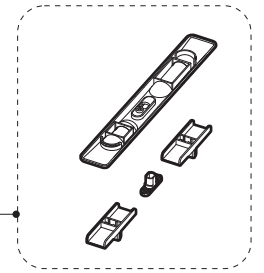

609



554

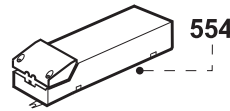

261



140

