

OPBOUW

VLAK GEÏNTEGREERD

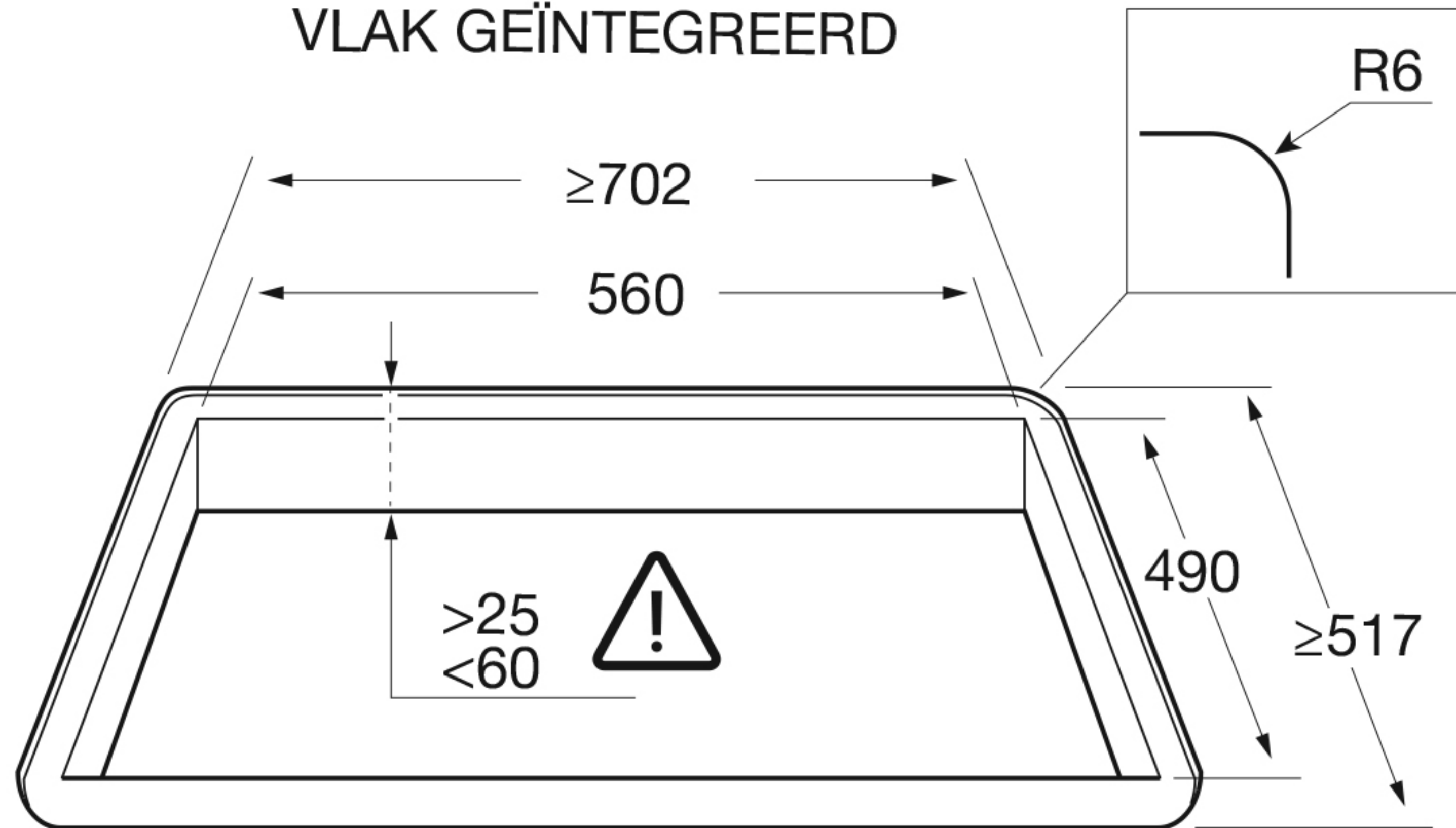

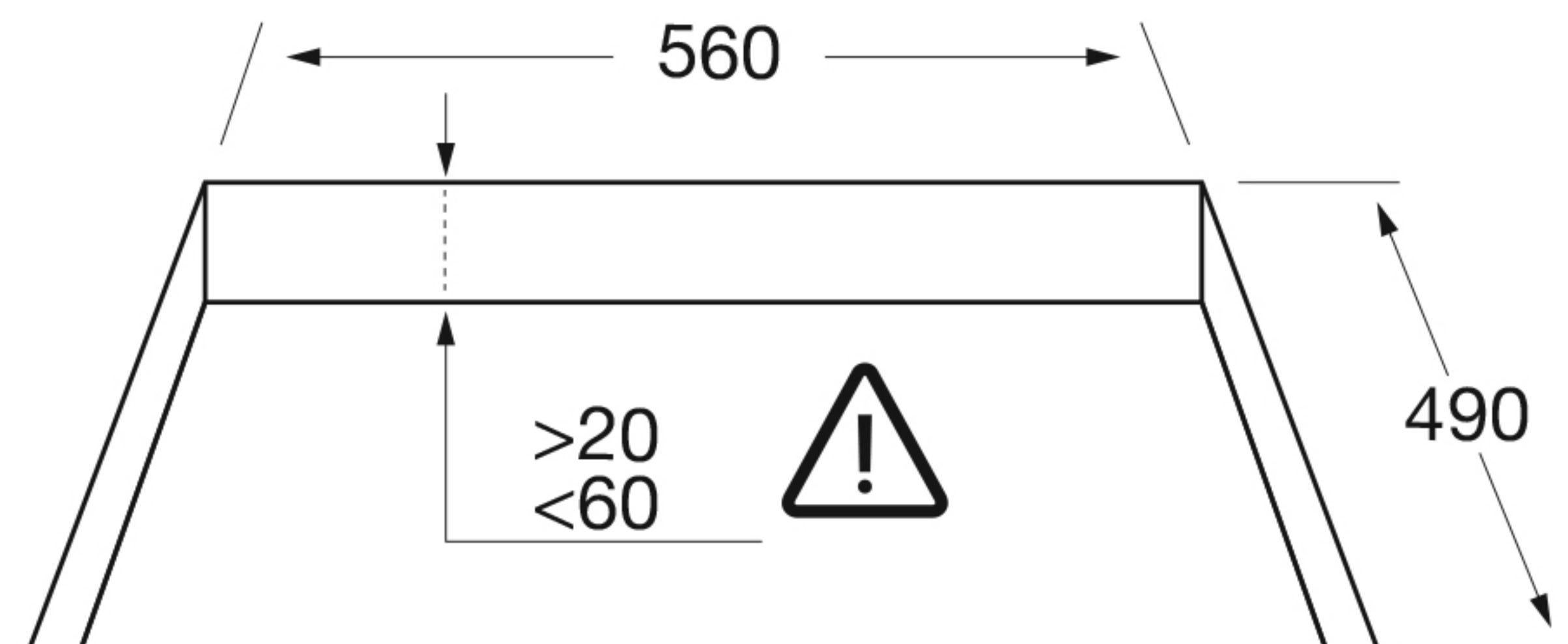
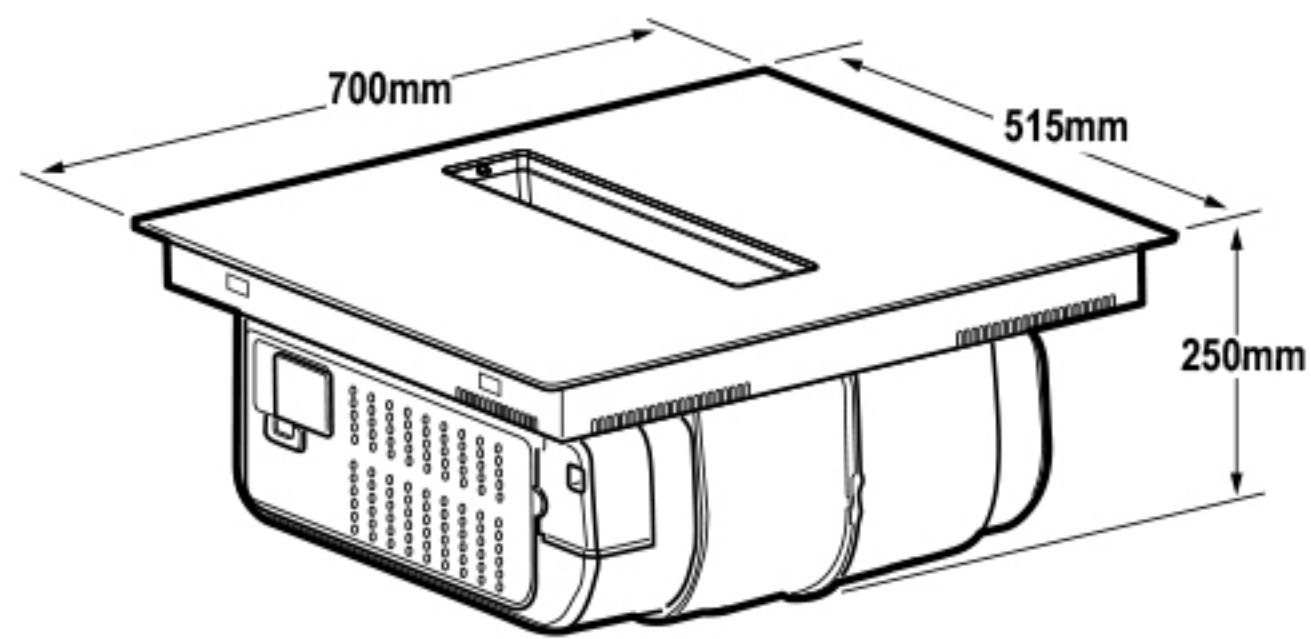

AKI671ZT

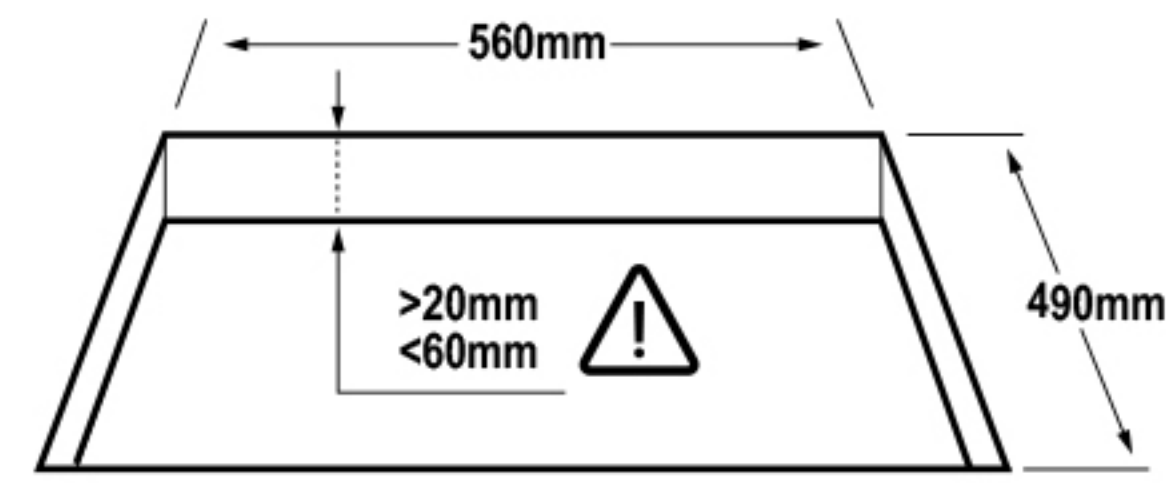

Opbouw

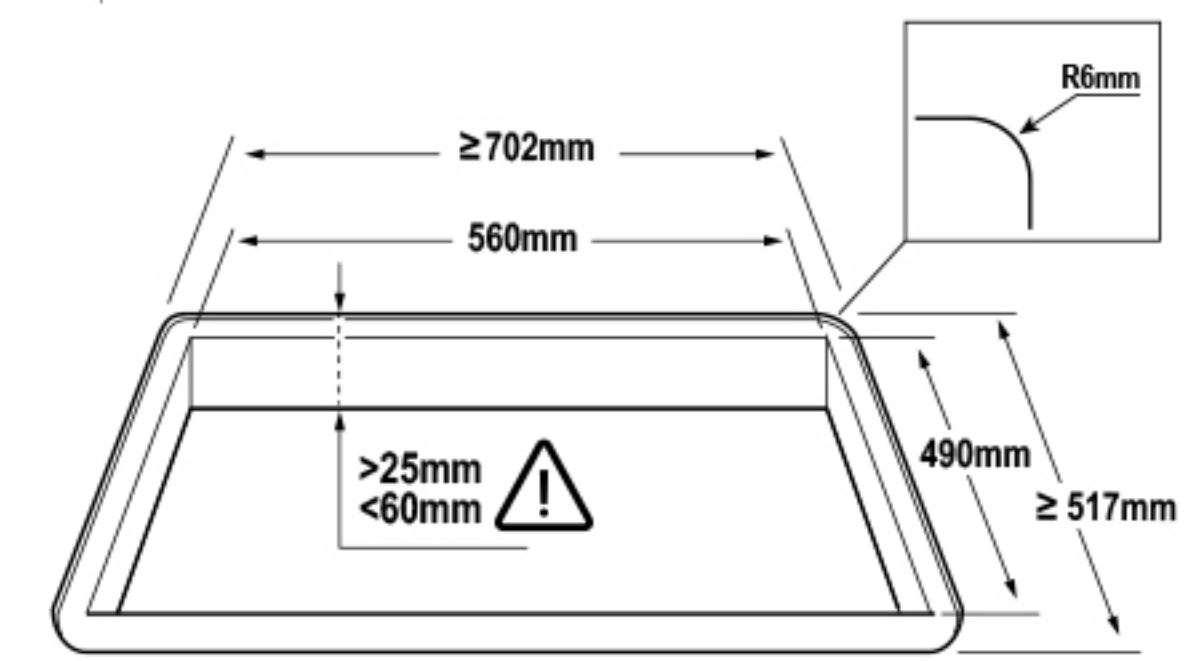

Vlak geïntegreerd

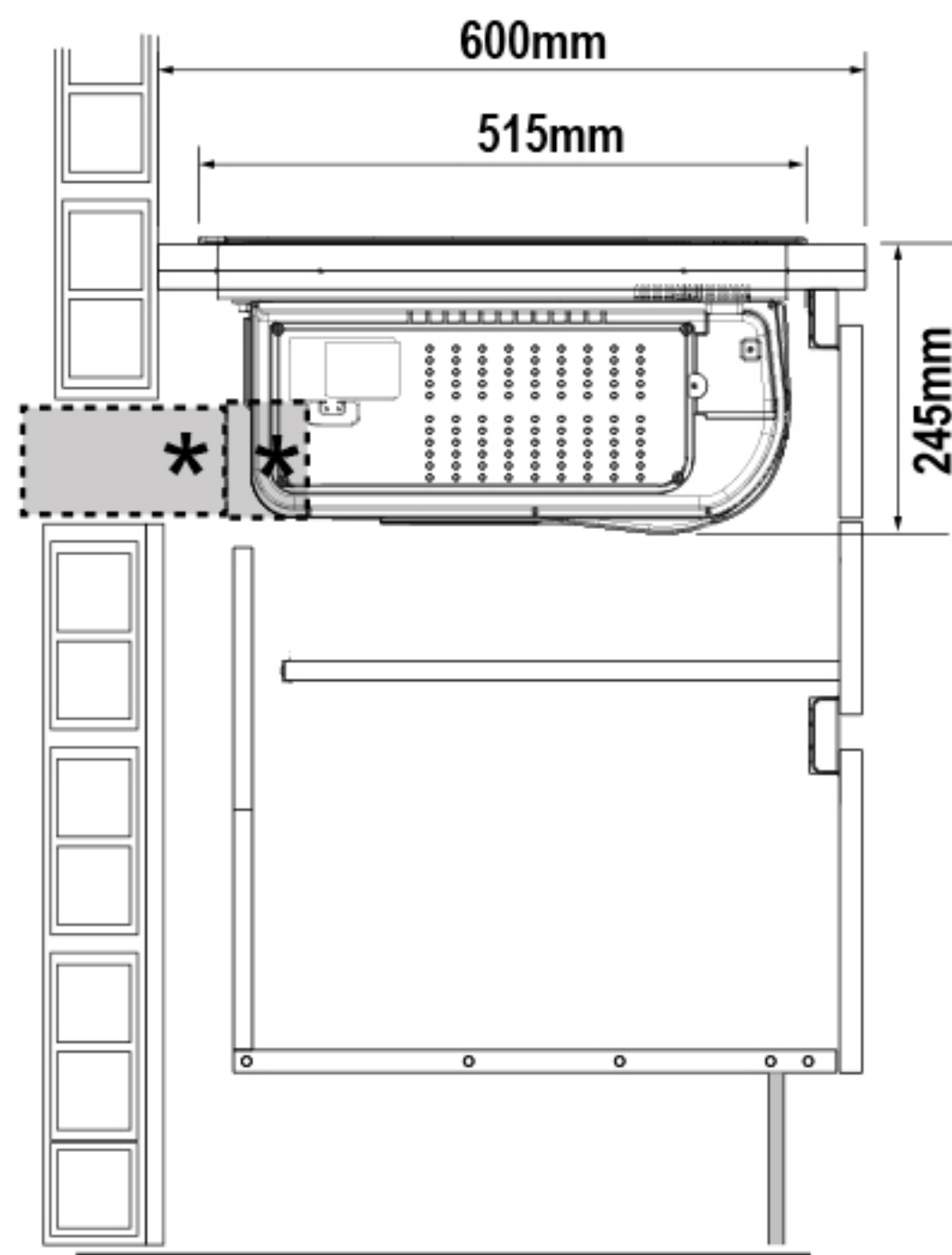

uitvoering 1: Afvoer naar buiten

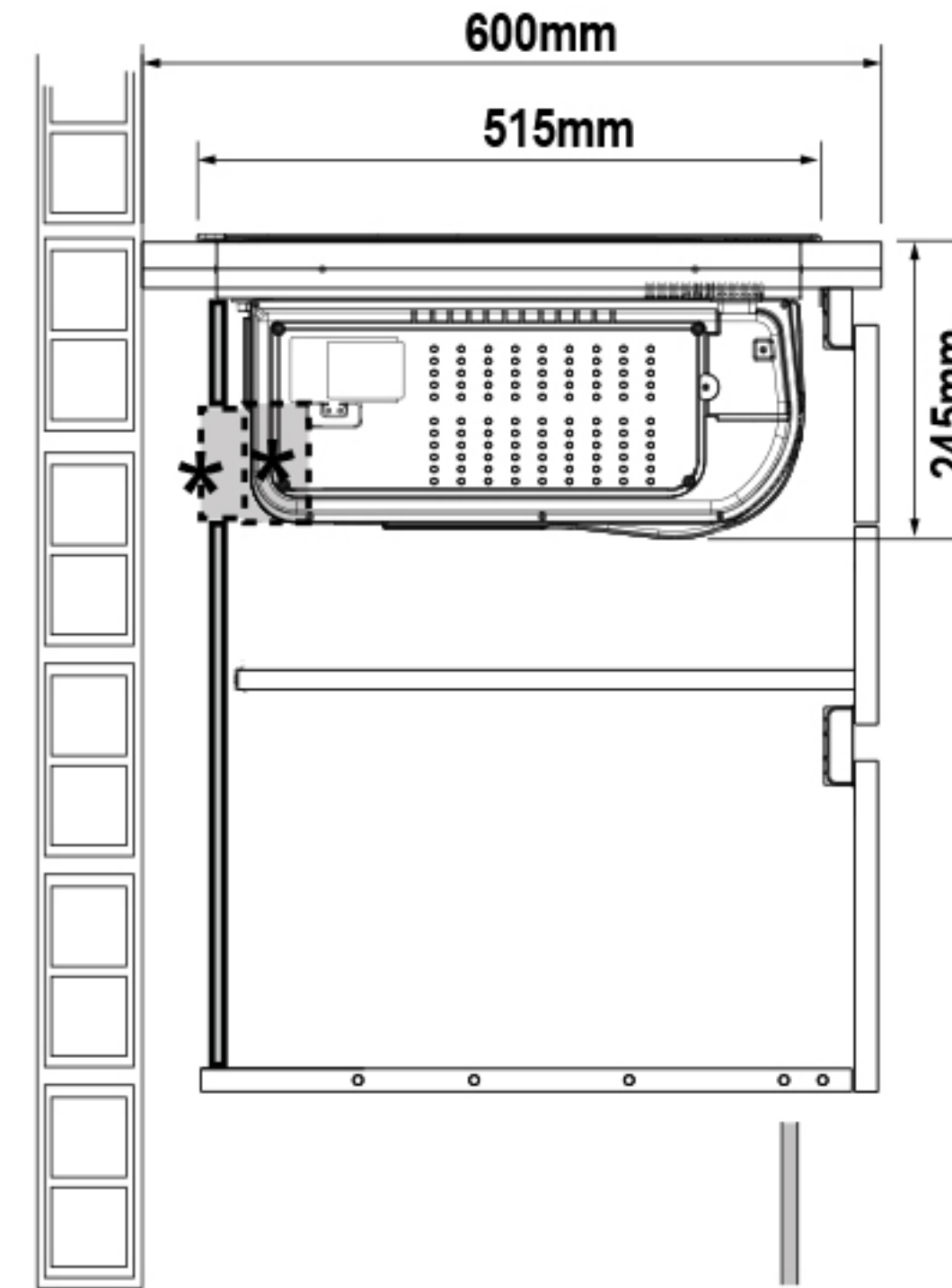

uitvoering 2: Recirculatie met startset voor uitblaas door de achterwand

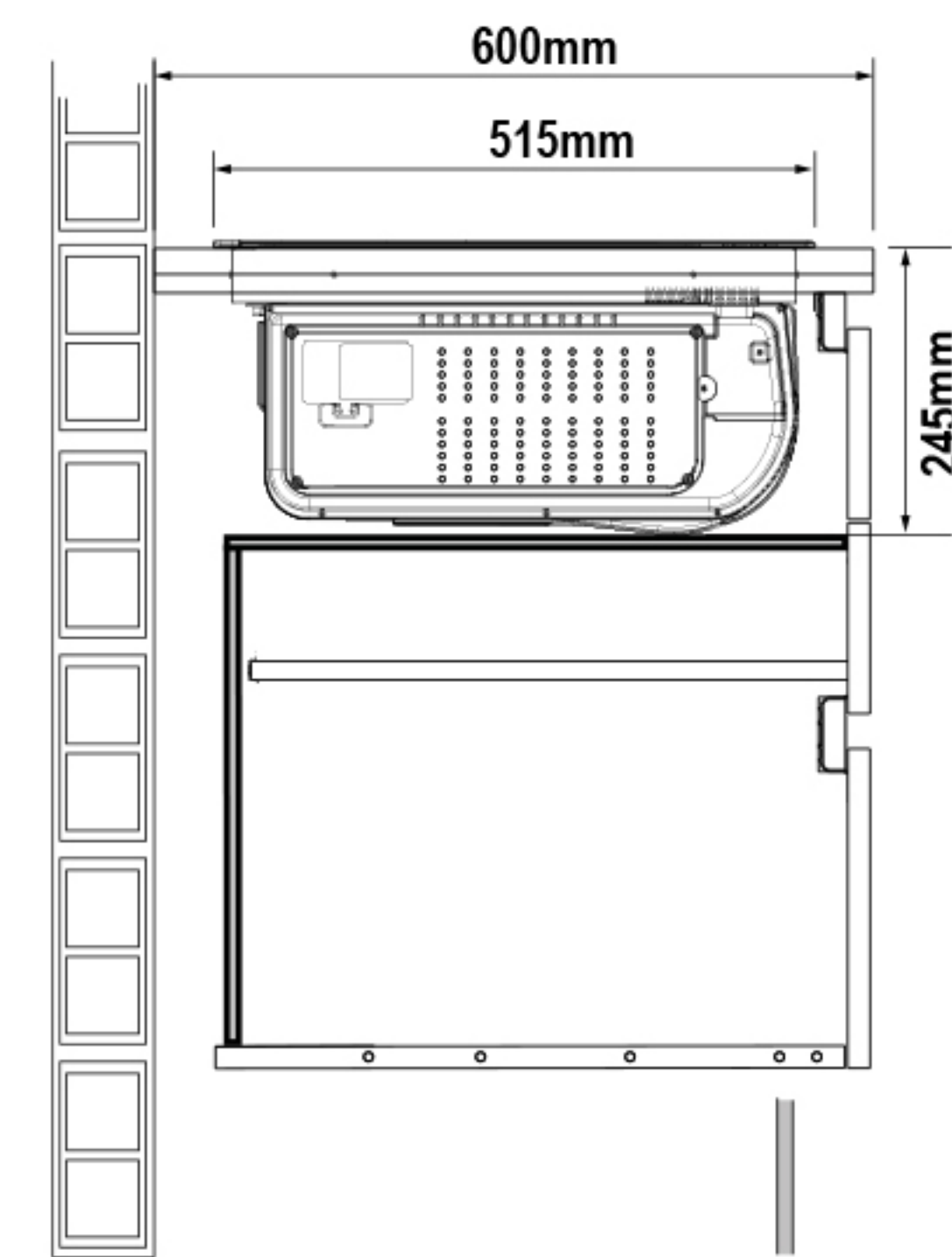

uitvoering 3: Recirculatie met bodem-achterwand combinatie

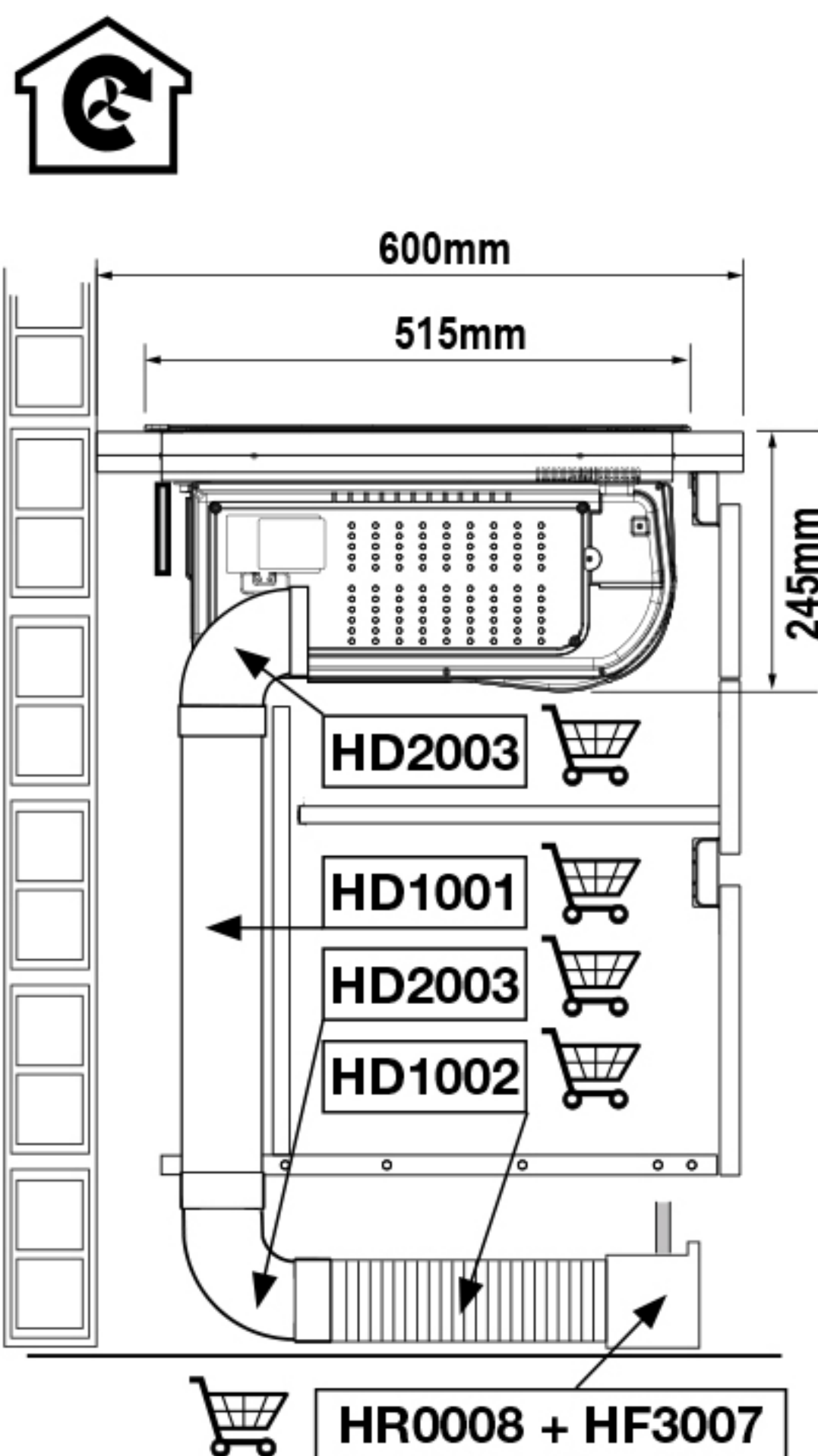

uitvoering 4: Recirculatie met uitblaas vooraan bij de plint

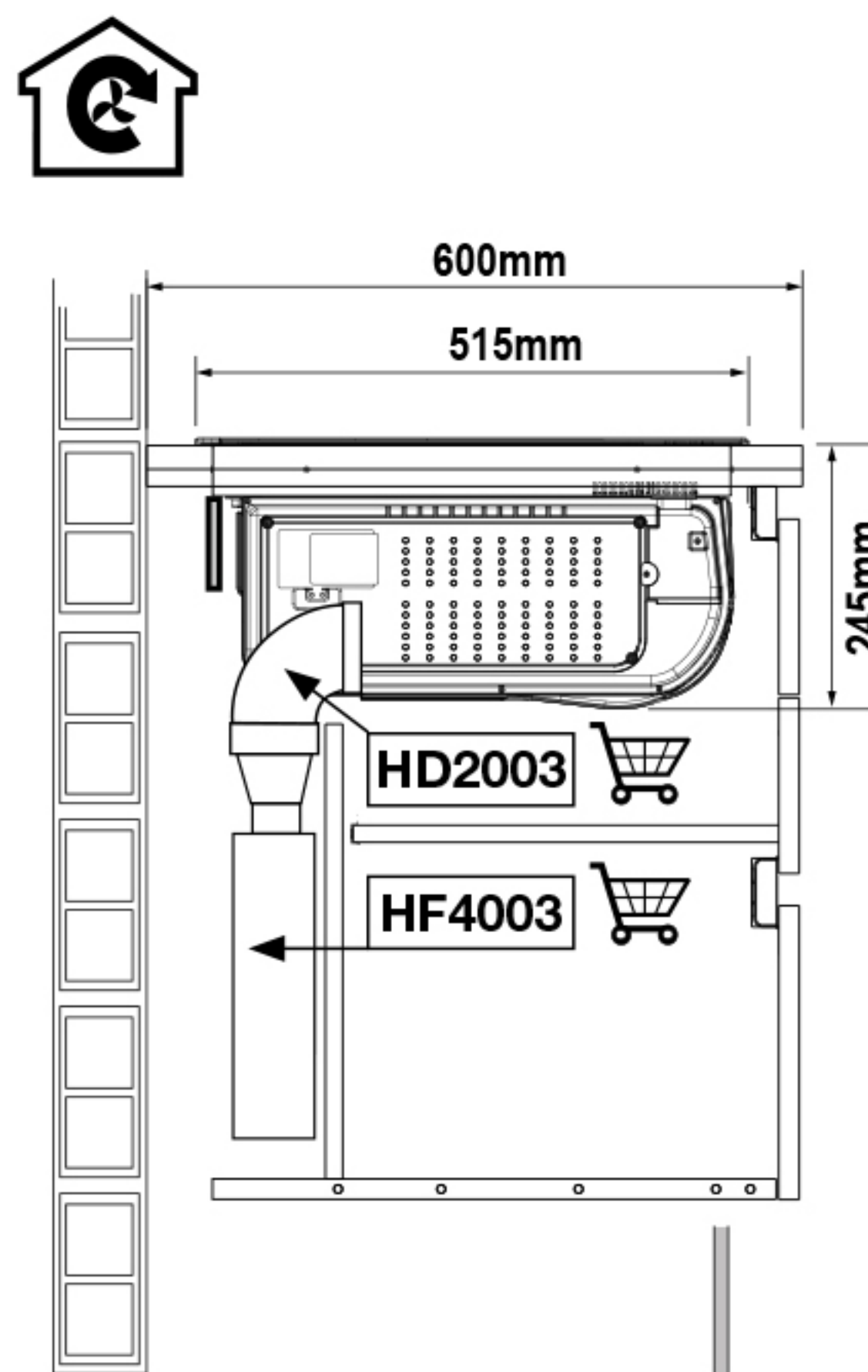

uitvoering 5: Recirculatie met Plasmafilter